

FEBRUARY
25 Cents
Over 200
Illustrations

RADIO NEWS

REC. U.S. PAT. OFF



Edited by HUGO GERNSBACK

RADIO PROSPECTING
SEE PAGE 716



TELEVISION
RADIOVISION
TELEVISION
RADIOVISION
TELEVISION
RADIOVISION
TELEVISION
RADIOVISION
TELEVISION
RADIOVISION

TELEVISION
RADIOVISION
TELEVISION
RADIOVISION
TELEVISION
RADIOVISION
TELEVISION
RADIOVISION
TELEVISION
RADIOVISION



SIX THOUSAND RADIO-TRICIANS

Are Now Equipped to Custom-Build 4 NEW HI-Q RECEIVERS

- 1 **Extreme selectivity**—achieved by the new doubly-tuned radio-frequency transformers, which are in reality tuned “band-pass” filters.
- 2 **Faithful reproduction**—hitherto unobtainable with such a high degree of selectivity—made possible by the “flat-top” “band-pass” filter-tuning characteristic of the radio-frequency amplifier.
- 3 **Great sensitivity**—affording reception over great distances by taking advantage of the enormous amplification possibilities of the shield-grid tubes used as radio frequency amplifiers.
- 4 **Mechanical perfection**—manifested by such features as the flat, rigid, accurately punched metal chassis, snug-fitting shields and full-floating bearing assembly for the ganged condensers.



All Hi-Q 29 receivers demand your attention for the same reason as the Master Hi-Q 29 shown above—finest parts, modern stage-shielded circuits, excellent selectivity and sensitivity and wonderful tone-quality at prices unequalled in present day radio. Junior Hi-Q 29 complete without cabinet, \$54.35; Junior A. C. Hi-Q 29, \$103.95; Master Hi-Q 29, \$99.50; Master A. C. Hi-Q 29, \$151.80.

AUTHORIZED Hi-Q Radio-Tricians in every neighborhood are building the 4 new Hi-Q 29 receivers to special order and to meet Local conditions—in every instance finer, more sensitive, more selective and beautifully toned instruments than is possible to secure through factory-built sets within \$50 to \$100 of their price.

The new Master Hi-Q 29 typifies the value of the entire group—a completely stage-shielded screen-grid receiver—steel chassis—only the finest parts available in Radio. Circuit is the result of America’s leading parts manufacturers. A Band Pass Filter, the latest development in radio, effects absolute FLAT TOP square cut-off TUNING with 10 kilocycle selectivity. “Cross-talk” is impossible. Only one station can be received at a time even in crowded high-power station areas. A “coast-to-coast” receiver that has wonderful sensitivity; unequalled DX reception; and a quality of tone that is totally new in radio. 4 models for battery or A. C.

NEW 80-PAGE HI-Q 29 CONSTRUCTION MANUAL

The biggest and most complete book of its kind ever published! Tells how to build the 4 new Hi-Q Receivers. Photos and diagrams illustrate every detail. Covers power amplifiers, tube and battery combinations, antennae, installation, short-wave adapters, house wiring and a wealth of other data on the Hi-Q custom-built radio. Price 25 cents including postage.

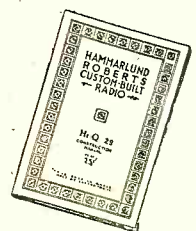

HAMMARLUND-ROBERTS, Inc.
1182-C BROADWAY, NEW YORK CITY

Associate Manufacturers



**Send Coupon Below for
FREE Radio
Idea Book**

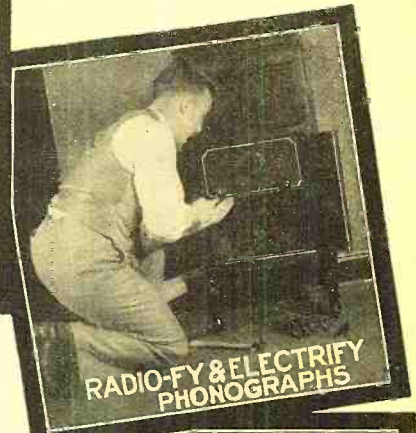
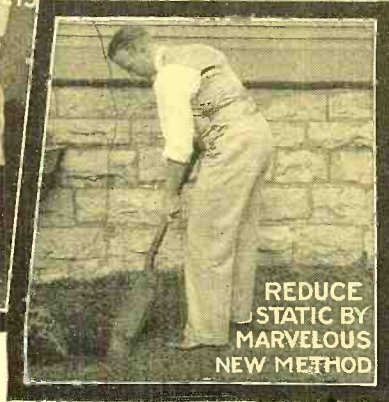

5 Easy Ways to Make \$300 an hour in Your Spare Time in RADIO

Each of these plans, developed by the Radio Association of America, is a big money-maker. Set owners everywhere want to get rid of static, to have their sets operate from the electric light socket, the tone improved, and the volume increased, and transformed into single-dial controls. Phonograph owners want their machines electrified and radiofied. If you learn to render these services, you can easily make \$3.00 an hour for your spare time, to say nothing of the money you can make installing, servicing, repairing, building radio sets, and selling supplies.

Over \$600,000,000 is being spent yearly for sets, supplies, service. You can get your share of this business and, at the same time, fit yourself for the big-pay opportunities in Radio by joining the Association.

Join the Radio Association of America

A membership in the Association offers you the easiest way into Radio. It will enable you to earn \$3.00 an hour upwards in your spare time—train you to install, repair and build all kinds of sets—start you in business without capital or finance an invention—train you for the \$3,000 to \$10,000 big-pay radio positions—help secure a better position at

bigger pay for you. *A membership need not cost you a cent!*

The Association will give you a comprehensive, practical, and theoretical training and the benefit of its Employment Service. You earn while you learn. Our cooperative plan will make it possible for you to establish a radio store. You have the privilege of buying radio supplies at wholesale from the very first.

Earned Over \$500.00 In His Spare Time

Frank J. Deutsch, Penn.: "I have made over \$500 out of Radio in my spare time. Yours is a great plan for ambitious men."

A Radio Engineer In One Year

Claude DeGraves, Canada: "I knew nothing about Radio when I joined the Association a year ago. I am now a member of the engineering staff of the DeForest Company and my income is 225% greater than at the time I joined."

Doubles Income In 6 Months

W. E. Thon, Chicago: "You have an excellent plan. Six months after I enrolled I secured the managership of large Radio store and doubled my income."

ACT NOW—If You Wish the No-Cost Membership Plan

To a limited number of ambitious men, we will give Special Memberships that may not—need not—cost you a cent. To secure one, write today. We will send you details and also our book filled with dollars-and-cents radio ideas. It will open your eyes to the money-making possibilities of Radio.

Radio Association of America
4513 Ravenswood Ave., Dept. RN-2 Chicago, Ill.

Radio Association of America
Dept RN-2 4513 Ravenswood Ave., Chicago, Ill.
Gentlemen: Please send me by return mail full details of your Special Membership Plan, and also copy of your Radio Idea Book.

Name.....
Address.....
City..... State.....

Please say you saw it in RADIO NEWS

RADIO NEWS

Volume 10

February, 1929

Number 8

HUGO GERNSBACK, Editor-in-Chief

ROBERT HERTZBERG, Managing Editor

C. P. MASON, Associate Editor

BERYL B. BRYANT, Laboratory Director

C. WALTER PALMER, Director Information Service

Contents of This Issue

The Short-Wave Fan By Hugo Gernsback	715	A 250-Type Amplifier and Power Pack By Joseph Riley	738
How Radio Prospecting Takes the Gamble Out of Mining By C. S. Gleason	716	Hints on Operation for the Short-Wave Beginner	742
What is Happening in the Television Field?	719	Constructing a Modulated Oscillator By John B. Brennan, Jr.	743
What's New in Radio	720	A Flexible Nine-Tube Superheterodyne By Coleman Sutton	746
Electrostatic Speakers Enter the Radio Field By Fritz Gabriel (Berlin)	723	Radio Wrinkles	748
The Radio Beginner—Condensers and Their Uses in Radio By C. P. Mason	726	Making Good Use of "B" Battery By- Products By L. B. Robbins	749
Outdoor and Indoor Aerials—How Their Signal Pick-Up Qualities Differ By Baron Manfred von Ardenne (Berlin)	729	On the Short Waves	750
Radio Tubes and Their Characteristics By H. M. Bayer	730	List of Broadcast Station Calls	752
The "Copperclad Special"—A Short-Wave Receiver de Luxe By Robert Hertzberg	733	RADIO NEWS Laboratories	754
		The Radio Constructor's Own Page	756
		I Want to Know By C. W. Palmer	757
		Broadcastistics	779
		Radiotics	781

In Our Next Number

THE RADIO NEWS 1929 HI-Q: This is the first broadcast receiver intended for construction by the custom radio builder and experimenter which uses band-pass filters with screen-grid tubes. This combination affords tremendous R.F. amplification with sharp 10-kilocycle tuning—something that has not been accomplished in any other screen-grid receiver we know of. A station which is tuned in with full volume over about two degrees on the dials disappears completely when the latter are turned half a degree either way; it does not linger weakly in the background to mar the reception of other stations on adjoining wavelengths.

The RADIO NEWS 1929 HI-Q is a flexible receiver, and may be adapted either to simple table cabinets or to large consoles containing set, loud speaker, power units and phonograph turntable with electrical pick-up. A very beautiful instrument, incorporating all the latter features, will be made the subject of a detailed Free Blueprint article.

Blueprint Notice

Readers desiring free blueprints of the sets described in this issue must use the coupon on Page 770. No blueprints will be sent without it.

RADIO NEWS is published on the 10th of each preceding month. There are 12 numbers per year. Subscription price is \$2.50 a year in U. S. and possessions. Canada and foreign countries, \$3.00 per year. U. S. Coin as well as U. S. Stamps accepted (no foreign coins or stamps). Single copies, 25 cents each. Checks and money orders should be drawn to order of EXPERIMENTER PUBLISHING CO., INC.

All communications and contributions to this journal should be addressed to Editor, RADIO NEWS, 230 Fifth Ave., New York, N. Y. Unaccepted contributions cannot be returned unless full postage has been included. All accepted contributions are paid for on publication. A special rate is paid for novel experiments; good photographs accompanying them are highly desirable. Publishers are not responsible for loss of manuscripts, although every precaution is taken with such manuscripts, upon receipt thereof.

RADIO NEWS. Monthly. Entered as second-class matter, July 12, 1924, at the Post Office at New York, N. Y., under the Act of March 3, 1879. Additional entry at Dunellen, N. J. and San Francisco, Calif. Title registered U. S. Patent Office, Copyright, 1929, by The Experimenter Publishing Co., Inc., 230 Fifth Ave., New York. The contents of this magazine are copyrighted and must not be reproduced in the United States without giving full credit to the publication. Translation into foreign languages must not be made unless permission is

The contents of RADIO NEWS are indexed in the Industrial Arts Index, copies of which can be found in every library.

obtained from the publishers. Copyrighted in Germany. Reproduction of articles in Germany is reserved for Radio, Berlin 42.

RADIO NEWS is for sale at all newsstands in the United States and Canada, and at Brentano's, Ave. de l'Opera, Paris, France. European agents: S. J. Wise Et Cie, 40 Place Verte, Antwerp, Belgium.

HOW TO SUBSCRIBE FOR RADIO NEWS. Send your name, address and remittance to Experimenter Publishing Co., 230 Fifth Ave., New York. Mention the name of the magazine you are ordering. We also publish SCIENCE AND INVENTION, RADIO LISTENERS' GUIDE and AMAZING STORIES. Write clearly.

RATES AND TERMS. The subscription rate for RADIO NEWS is \$2.50 per year. (12 numbers). When remitting do so by check, money order, or registered letter if cash is enclosed. Avoid sending cash through the mail if possible. Subscriptions for less than one year are not accepted. Subscription may be made in combination with SCIENCE & INVENTION, RADIO LISTENERS' GUIDE, and AMAZING STORIES.

POSTAGE. We prepay postage in all parts of the United States, Mexico and island possessions. For foreign or Canadian subscriptions we require 50 cents in addition to the subscription price for additional postage charge.

CHANGE OF ADDRESS. Notify us as far in advance as possible. It requires several weeks to make an address change on our records. Always write clearly.

Published by **Experimenter Publishing Company, Inc.**

H. GERNSBACK, President

S. GERNSBACK, Vice-President and Treasurer IRVING S. MANHEIMER, Secretary

Member: Audit Bureau of Circulations

Radio Magazine Publishers Association

Advertising Representatives: RHODES & LEISENRING

New York Offices: 624 Graybar Building

Chicago Offices: 307 North Michigan Ave.

Editorial and General Offices

230 Fifth Avenue, New York City

SAY FELLOWS LEARN ELECTRICITY

Let me tell you in my big Free book about my AMAZINGLY EASY way to quickly train you for jobs leading to salaries of \$60⁰⁰ to \$200⁰⁰ a week. NOT BY CORRESPONDENCE. NOT BY BOOKS



H. C. LEWIS—
President

But, on real electrical machinery and I train you in 90 DAYS you don't need advanced education or electrical experience. EARN WHILE YOU LEARN. Free employment service for life when you graduate. If you enroll now I include at no extra cost my big new course AVIATION ELECTRICITY

mail the coupon today for my big free book or I'll tell you the whole story



COYNE ELECTRICAL SCHOOL

H. C. LEWIS, Pres., Dept. 29-77 Est. 1899
500 So. Paulina Street, Chicago

FILL OUT - MAIL TODAY!

H. C. LEWIS, President
COYNE ELECTRICAL SCHOOL, Dept. 29-77
500 So. Paulina Street, Chicago, Ill.

Dear Mr. Lewis: Without obligation send me your big free catalog and all details of Free Employment Service, Aviation, Radio and Auto-motive Electrical Courses that are included and how many "earn while learning." I understand I will not be bothered by any salesman.

Name

Address

City State

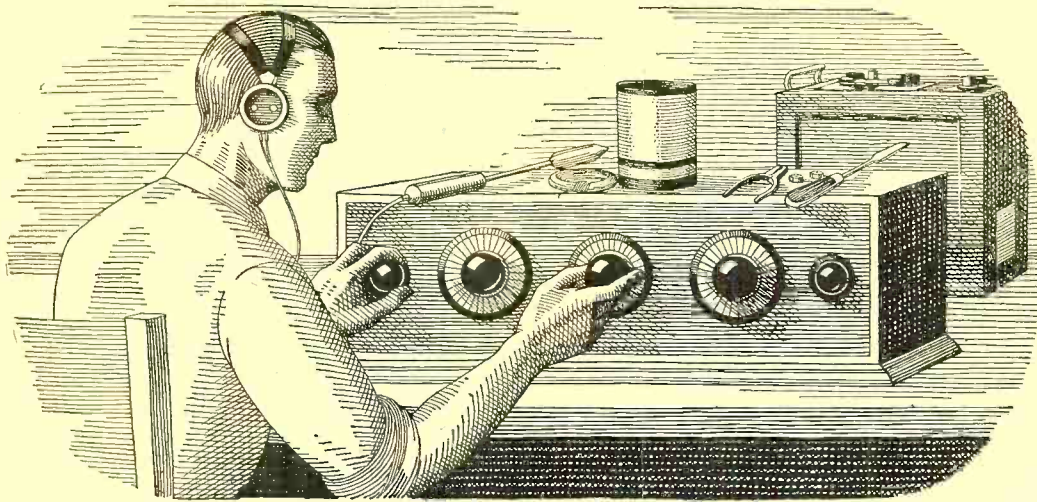

If all the Radio sets I've "fooled" with in my time were piled on top of each other, they'd reach about halfway to Mars. The trouble with me was that I thought I knew so much about Radio that I really didn't know the first thing. I thought Radio was a plaything—that was all I could see in it for me.

I Thought Radio Was a Plaything

But Now My Eyes Are Opened, And I'm Making Over \$100 a Week!

\$50 a week! Man alive, just one year ago a salary that big would have been the height of my ambition.

Twelve months ago I was scrimping along on starvation wages, just barely making both ends meet. It was the same old story—a little job, a salary just as small as the job—while I myself had been dragging along in the rut so long I couldn't see over the sides.

If you'd told me a year ago that in twelve months' time I would be making \$100 and more every week in the Radio business—whew! I know I'd have thought you were crazy. But that's the sort of money I'm pulling down right now—and in the future I expect even more. Why only today—

But I'm getting ahead of my story. I was hard up a year ago because I was kidding myself, that's all—not because I had to be. I could have been holding then the same sort of job I'm holding now, if I'd only been wise to myself. If you've fooled around with Radio, but never thought of it as a serious business, maybe you're in just the same boat I was. If so, you'll want to read how my eyes were opened for me.

When broadcasting first became the rage, several years ago, I first began my dabbling with the new art of Radio. I was "nuts" about the subject, like many thousands of other fellows all over the country. And no wonder! There's a fascination—something that grabs hold of a fellow—about twirling a little knob and suddenly listening to a voice speaking a thousand miles away! Twirling it a little more and listening to the mysterious dots and dashes of steamers far at sea. Even today I get a thrill from this strange force. In those days, many times I stayed up almost the whole night trying for DX. Many times I missed supper because I couldn't be dragged away from the latest circuit I was trying out.

I never seemed to get very far with it, though. I used to read the Radio magazines and occasionally a Radio book, but I never understood the subject very clearly, and lots of things I didn't see through at all.

So, up to a year ago, I was just a dabbler—I thought Radio was a plaything. I never realized what an enormous, fast-growing industry Radio had come to be—employing thousands and thousands of trained men, I

usually stayed home in the evenings after work, because I didn't make enough money to go out very much. And generally during the evening I'd tinker a little with Radio—a set of my own or some friend's. I even made a little spare change this way, which helped a lot, but I didn't know enough to go very far with such work.

And as for the idea that a splendid Radio job might be mine, if I made a little effort to prepare for it—such an idea never entered my mind. When a friend suggested it to me one year ago, I laughed at him.

"You're kidding me," I said.
"I'm not," he replied. "Take a look at this ad."

He pointed to a page ad in a magazine, an advertisement I'd seen many times but just passed up without thinking, never dreaming it applied to me. This time I read the ad carefully. It told of many big opportunities for trained men to succeed in the great new Radio field. With the advertisement was a coupon offering a big free book full of information. I sent the coupon in, and in a few days received a handsome 64-page book, printed in two colors, telling all about the opportunities in the Radio field, and how a man can prepare quickly and easily at home to take advantage of these opportunities. Well, it was a revelation to me. I read the book carefully, and when I finished it I made my decision.

What's happened in the twelve months since that day, as I've already told you, seems almost like a dream to me now. For ten of those twelve months, I've had a Radio business of my own. At first, of course, I started it as a little proposition on the side, under the guidance of the National Radio Institute, the outfit that gave me my Radio training. It wasn't long before I was getting so much to do in the Radio line that I quit my measly little clerical job, and devoted my full time to my Radio business.

Since that time I've gone right on up, always under the watchful guidance of my friends at the National Radio Institute. They would have given me just as much help, too, if I had wanted to follow some other line of Radio besides building my own retail business—such as broadcasting, manufacturing, experimenting, sea operating, or any one of the score of lines they prepare you for. And to think that until that

day I sent for their eye-opening book, I'd been wailing "I never had a chance!"

Now I'm making, as I told you before, over \$100 a week. And I know the future holds even more, for Radio is one of the most progressive, fastest-growing businesses in the world today. And it's work that I like—work a man can get interested in.

Here's a real tip. You may not be as bad off as I was. But think it over—are you satisfied? Are you making enough money, at work that you like? Would you sign a contract to stay where you are now for the next ten years—making the same money? If not, you'd better be doing something about it instead of drifting.

This new Radio game is a live-wire field of golden rewards. The work, in any of the 20 different lines of Radio, is fascinating, absorbing, well paid. The National Radio Institute—oldest and largest Radio home-study school in the world—will train you inexpensively in your own home to know Radio from A to Z and to increase your earnings in the Radio field.

Take another tip—No matter what your plans are, no matter how much or how little you know about Radio—clip the coupon below and look their free book over. It is filled with interesting facts, figures, and photos, and the information it will give you is worth a few minutes of anybody's time. You will place yourself under no obligation—the book is free, and is gladly sent to anyone who wants to know about Radio. Just address J. E. Smith, President National Radio Institute, Dept. 9NT, Washington, D. C.

J. E. SMITH, President,
National Radio Institute,
Dept. 9NT, Washington, D. C.

Dear Mr. Smith:
Please send me your 64-page free book, printed in two colors, giving all information about the opportunities in Radio and how I can learn quickly and easily at home to take advantage of them. I understand this request places me under no obligation, and that no salesman will call on me.

Name.....
Address.....
Town.....State.....
Occupation.....

Please say you saw it in RADIO NEWS

SM

Huge Amplifying Power

- 250 type tubes, singly or in push-pull, with unbeatable S-M tone quality
- built into an existing receiver, or separately for radio and phonograph amplification
- at prices below all competition
- this is the S-M power amplifier story!

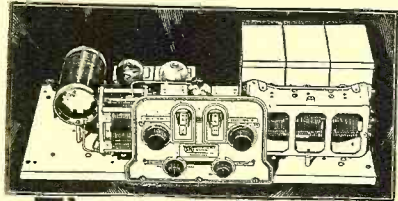
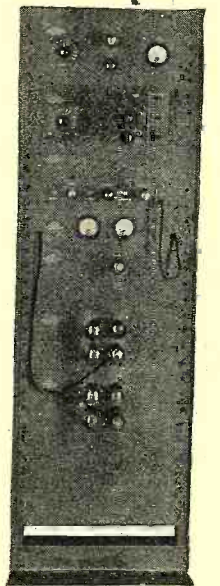
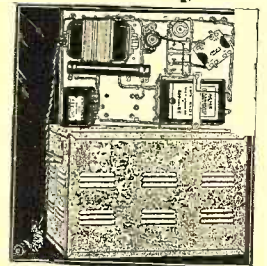
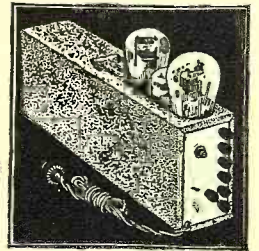

S-M 720 Screen Grid Six

(See description on opposite page.)

Read What They Say About It—

Gentlemen:

I have had this kit in actual operation for over a month and am astounded with the results. . . Stations which my friends and myself had given up as "lost at sea" have come thru like a ghost from the grave, and dance volume from a loudspeaker from the Pacific coast is a reality instead of a will-o-the-wisp. And knife-edge selectivity. What a treat!

F. Lordan, Galveston, Texas.

Gentlemen:

On my set, which is a Silver Marshall Screen Grid Six, I am using a loop, and it might be interesting to you to know that in testing with the loop for distance this last week I received (at Rochester, N. Y.) Los Angeles, Hot Springs, Arkansas; Davenport, Iowa; Jacksonville, Florida and Omaha, Nebraska.

Clayton R. Bragg, Rochester, N. Y.

Gentlemen:

Between 4:30 P.M. and 9:00 P.M.—knocking off about an hour for supper—I logged 63 stations within a radius of 2000 miles. Calgary, Alta., Canada, came in with pretty good volume and an Army band in St. Paul, Minn. nearly tore the speaker apart.

Jos. H. Malkin, South Norwalk, Conn.

If you build professionally, write us about the Service Station franchises. Or if you don't build, yet want your radio to be custom-made, S-M will gladly refer your inquiry to an Authorized Silver-Marshall Service Station near you.

Are you receiving "The Radiobuilder" regularly? Every issue describes new and interesting radio developments. To all Authorized S-M Service Stations, it comes free of charge; to others a nominal charge is made. Use this coupon.

- Silver-Marshall, Inc.
848 W. Jackson Blvd., Chicago, U. S. A.
- ...Please send me, free, the complete S-M Catalog; also sample copy of The Radiobuilder.
- For enclosed.....in stamps, send me the following:
- 50c Next 12 issues of The Radiobuilder
 - \$1.00 Next 25 issues of The Radiobuilder
 - S-M DATA SHEETS as follows, at 2c each:
 - No. 1. 670B, 670ABC Reservoir Power Units
 - No. 2. 685 Public Address Unipac
 - No. 3. 730, 731, 732 "Round-the-World" Short Wave Sets
 - No. 4. 223, 225, 226, 256, 251 Audio Transformers
 - No. 5. 720 Screen Grid Six Receiver
 - No. 6. 740 "Coast-to-Coast" Screen Grid Four
 - No. 7. 675ABC High-Voltage Power Supply and 676 Dynamic Speaker Amplifier
 - No. 8. Sargent-Rayment Seven
 - No. 9. 678PD Phonograph Amplifier
-Name
.....Address

As a separate two-stage amplifier for homes and small theatres, working from radio or phonograph into a dynamic speaker, using one each '50, '26 and '81 tubes, the S-M 678PD far outclasses, in quality and price, any competitive amplifiers at prices up to double that of the 678PD: WIRED \$73; KIT complete \$65.

For portable use, to cover 2,000-seat or larger auditoriums, or outdoor crowds of up to 15,000, with optional voice, radio or record input—the S-M 685 three-stage Public-Address Amplifier is ideal. WIRED \$160, KIT \$125.

Conversion of any existing receiver to use '10 or '50 type power tubes is accomplished with no change of wiring, by using S-M 675ABC power supply which supplies all ABC power for the power tube, and receiver B as well. WIRED, \$58; KIT, \$54.

For large theatres, schools, hospitals, auditoriums or stadiums requiring the finest amplifying equipment, the S-M "PA" Rack-and-Panel Amplifiers, consisting of any required number of standard or special unit panels, will provide for any class of coverage. The system illustrated allows optional selection of one of two microphones, radio, or record input, with master gain control, visual volume level indicator, three-stage input amplifier, test meter panel, input amplifier power supply, and two socket-powered push-pull output panels of 15 watts undistorted power output each. With a voltage gain of over 5,000 times, a frequency characteristic flat to 2 T.U.'s from 30 to 4,000 cycles (with cut-off at 4,500 cycles) and with hysteretic distortion practically eliminated, the performance of S-M "PA" type amplifiers is unconditionally guaranteed equal or superior to any and all competitive American equipment.

Full information on these new amplifiers, as well as on the 720 Screen Grid Six and other S-M sets and kits, is contained in the new December edition of the S-M 24-page general catalog. Ask for it, or send two cents for Data Sheet No. 9 covering the 678PD Amplifier.

New Push-Pull Apparatus

And now, S-M is glad to announce new super-quality push-pull audio transformers built on the Clough system, all offering curves flat from below 50 cycles to well above 5,000 cycles—transformers that give to "push-pull" a new and really startling significance. And their prices like their quality are unbeatable!

The new 257 is a push-pull input type, to operate from one amplifier tube into two 171A, 210, or 250 tubes, and lists at the low price of only \$7.00. Type 227 is a push-pull inter-stage transformer, to feed from two 112A, 226, or 227 tubes into two 112A, 226, 227 or 171A, 210 or 250 tubes, and lists at \$8.00.

Type 258 tapped output impedance is intended to feed from two 171A tubes into any standard speakers. Price \$5.00. Type 248 Universal output choke is designed to feed out of two 210 or 250 tubes into one to six or more standard speakers, and is provided with several impedance-matching taps. It will handle over 20 watts without core saturation. Price, 248 open mounted \$7.00; or 228 (in same case as 227) \$8.00.

Remember—S-M guarantees these push-pull transformers to have a finer frequency characteristic than any and all competitive types—bar none.

SILVER-MARSHALL, Inc.
848 West Jackson Blvd., Chicago, U. S. A.

Please say you saw it in RADIO NEWS

Barawik - the Old Reliable RADIO SERVICE

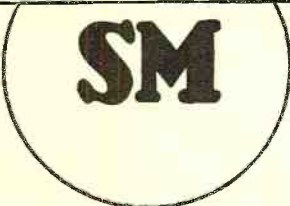

Official
Distributors
and
Headquarters
for SM Products

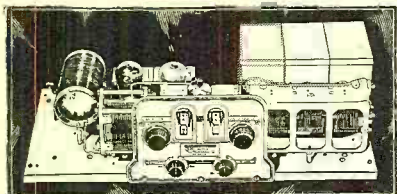
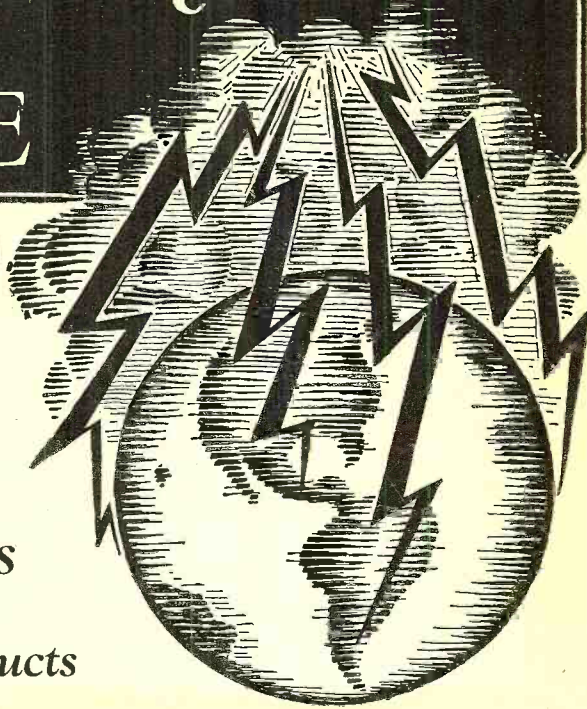

S-M 720 Screen-Grid Six

Barawik, the Old Reliable Radio House, is well known to readers of Radio News. As official wholesale distributors for the products of the Silver-Marshall laboratories, Barawik offers you this big line of radio merchandise with the assurance that your orders will be filled on the very day they are received. Being located only a few blocks from the Silver-Marshall factories, Barawik can give you service such as you can secure nowhere else.

Order your favorite S-M parts, Kits and supplies here. You'll save time and money by so doing. By dealing with Barawik, you will be able to get better service, quicker deliveries and honest treatment always. Over a quarter million satisfied customers know that Barawik service and Barawik prices can't be beat. Thousands of Radio News readers are regular Barawik customers and can testify to these facts.

A NEW SERVICE TO RADIO NEWS READERS

In addition to a full line of Silver-Marshall parts, Kits and sets, Barawik offers to you a complete line of everything in the radio field—sets, radio furniture, tubes, power units, portable receivers, dynamic and other speakers, parts and kits for all popular circuits, short wave and television supplies, short wave transmitters, radiophones, public address systems, novelties, etc. as advertised in Radio News and other radio publications.

Barawik also sells, at lowest money-saving prices, to customers the world over, auto tires and tubes, auto accessories, electrical goods, lighting fixtures, wiring material, household appliances, stoves, vacuum cleaners, washing machines, camping equipment, sporting goods, golf and baseball supplies, outing clothing and thousands of the things you and everyone else needs the year 'round for home, office, work and recreation.

Our central location insures fast service to customers in all parts of the country.

Radio News readers will find in the Barawik Radio Catalog and Guide thousands of choicest bargains—the very things you need and use in everyday life. If you haven't a copy of this big Cyclopedic, send for it at once. It is free—mail the handy coupon below, while it is before you. Send today—now!

The Barawik Co.

218-M Canal Station
CHICAGO, ILL., U. S. A.



SM
710
and
720
KITS

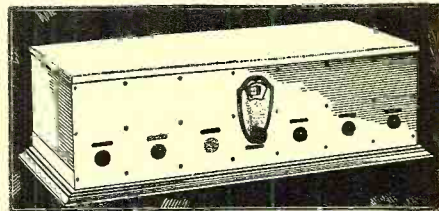

S-M 720 Sargent-Rayment Seven

720 SCREEN GRID SIX

The new S-M 720 embodies in the most perfect form the revolution that screen-grid tubes have brought about in long-distance reception. Three of these tubes in the R.F. stages, with shielded S-M coils, bring in distant stations on the next 10 kc. channel to powerful locals! The new S-M 255 and 256 transformers set a far higher standard of tone quality than ever known before. Custom-built complete in 700 cabinet, list, \$102.00; complete kit, with pierced metal chassis and antique brass escutcheon but without cabinet, list, \$72.50.

710 SARGENT-RAYMENT SEVEN

Designed by two famous engineers to give the very extreme of results now possible in broadcasting reception, irrespective of cost, the S-M 710 Sargent-Rayment Seven sets an entirely new standard. Exhausting the tremendous distance possibilities of 4-screen-grid R.F. stages—bringing in a station on every 10-kilocycle channel right around its single-control dial (with five auxiliary vernier knobs)—equipped with the unequalled S-M Clough system audio amplifier—yet the 710 is only \$175 list custom-built complete, or \$130 list for kit including aluminum cabinet.

THE BARAWIK CO.,
218-M Canal Sta., Chicago, Ill., U.S.A.

Please send me, free of charge, your new 1929 Catalog and Buyers' Guide of high-grade radio sets, kits, parts, and accessories—including a full line of S-M products and the many new goods for Spring and Summer.

Name.....

Address.....

Please say you saw it in RADIO NEWS

Let Me Start you in this ~ Amazing new Business Of your Own ~ Now!

**\$500
DOWN STARTS
YOU**

**MAKE \$5,000 TO
\$15,000 A YEAR in
Your Own Home, Basement
or Garage Charging and Re-
pairing Batteries**

Here's your great opportunity to get into a Big Pay field that's growing by leaps and bounds—charging and repairing batteries. A \$5 deposit brings all the tools and equipment to get started in a real business of your own that brings you \$5,000 to \$15,000 a year. Clip coupon below and get complete facts.



**\$950 IN 5 WEEKS
FOR TREGO**

"I never dreamed money was so easy to make. Your charger has given me independence I never before enjoyed."

**Pocket 90c Clear Profit on
Every Battery**

I have invented a new Service Station Charger which saves 40% to 60% in electric current, yet handles 50% to 70% more batteries than similar outfits. Millions and millions of batteries in daily use by auto owners everywhere. Amazing new principle of my Service Station Charger simply scoops up all the business in town for you. My Free Book tells you how to get started.

**\$5.00 Is All You Need
to Start**

Clip coupon and get your Free copy of my book "Big Profits." Read how hundreds of other fellows like yourself have established themselves in their own business. See the description of my amazing Service Station Charger. Find out about my plan for establishing you in this Big Pay field for only \$5. Along with the charger goes my complete outfit of tools, supplies, testers, advertising—in fact everything that you need to do business—you can take in \$20 a day or more right from the start. Get your copy of this book quick.

**No Experience or Education
Required**

Why go along at \$25, or \$30 a week when the battery fields holds out an opportunity for you to make upwards of \$5,000 a year? Easy to get started with my charger. When the outfit arrives, you're all ready to begin business. Simply let the business roll in. Charger is automatic and requires no attention during operation. Profits go into your pocket without effort on your part. Free Book tells how.



**\$425 IN 18 DAYS
FOR WHALEN**

"I am now making money easier than at my job. Thank you for the wonderful prosperity your charger has given me."

**Free Advertising, Tools, and
Working Outfits**

As an owner of my charger you get the benefit of my advertising. When you open up, customers come right to your door. No soliciting—no plugging for business. Everybody is more than anxious to give you their trade.

Operate in Full or Spare Time

At first you can still work on your regular job. Go to your job in the morning and your batteries will be fully charged when you come home. You can make more money in this way during your spare time than at your job. Free book explains just how to do it.

GET YOUR COPY OF BIG PROFITS

Over 100 Illustrations

Find out the facts for yourself without one cent of expense. Read what the other fellows are doing. Let me show you how easy it is to get started—with only \$5.00 and how quickly you can build up your own business netting you \$5,000 to \$15,000 a year. Clip and mail coupon now.



Address Me Personally

C. F. HOLMES, Chief Eng.
Independent Electric Works, Dept. 90
5116 Ravenswood Avenue
Chicago, Ill.

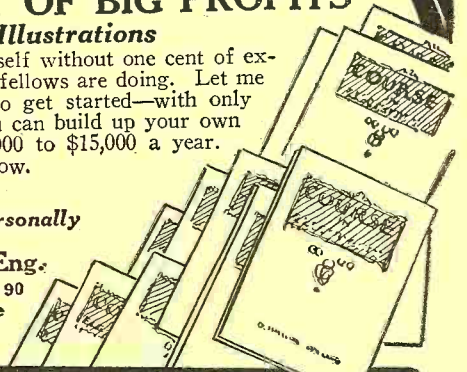

Clip Coupon Quick ~

C. F. HOLMES
5116 Ravenswood Ave., Dept. 90
Chicago, Ill.

Rush me by return mail a copy of your Free Book "Big Profits."

Name.....

Address.....

.....



If you are earning Less than \$90.00 a week mail Coupon

Pick the RADIO JCB you want and fill it in only 9 months!

By means of this "Big-League" home-training sponsored by Radio Corporation of America, General Electric and Westinghouse.



Radio Operator
\$90 to \$200 per month
with all expenses paid



Broadcast Operator
\$1,800 to \$4,800 a year

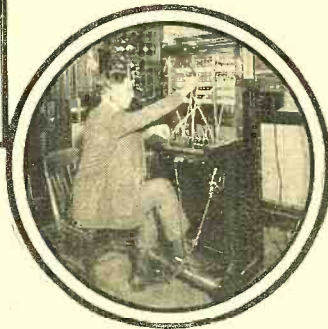

Radio Inspector
\$2,000 to \$4,500 a year

Send for FREE BOOK about Radio.

WHY struggle along on less than \$45 a week? Why wait years for success that can be yours in only 9 months?

As a result of a marvelous new kind of home-study training in Radio, hundreds of men are today leading straight for financial independence! Radio pays from \$2,000 to \$25,000 a year. The work is thrilling . . . the hours are short. Vacations with pay . . . opportunities for seeing the world . . . adventure galore!

Prepare at Home with this Big Laboratory Outfit Get the "How" as well as the "Why" of Radio—with this expert training! Only an hour or so a day—in spare time—is all you need! As part of your course, you receive absolutely free of extra charge—a magnificent outlay of apparatus. With this outfit you learn to build fine sets and solve the problems that bring big pay.

Training sponsored by

RCA . . . General Electric . . . Westinghouse

Our graduates are in big demand everywhere. They enjoy greater success because they're posted right up-to-the-minute in everything in Radio. Radio's progress each year is measured by the accomplishment of the great engineers at work in the research laboratories of RCA, General Electric and Westinghouse.

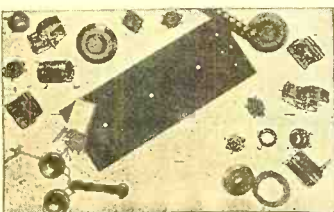

Limited space permits of only a small picture of the great outlay of apparatus given with the course.



These three Radio organi-

zations set the standards for the industry, and stand back of every lesson in the course.

Money Back if Not Satisfied

The lessons prepare you for success in all phases of Radio—manufacturing, servicing, selling, ship and shore broadcasting, Television, Photoradiograms and Radio equipment. A signed agreement backed by RCA assures you of complete satisfaction upon completion of the training—or your money will be promptly refunded.

Read This Thrilling Free Book

It gives you the real "dope" about Radio and describes in detail the famous training that has enabled us to place thousands of our students in fine positions, usually from 3 to 10 days after graduation. It may mean the turning point in your life. It tells in 50 fascinating pages and photos all about Radio's brilliant opportunities for adventure and success. Mail the coupon now—the book is absolutely free!

Radio Institute of America, Dept. RN-2, 326 Broadway, New York.



Radio Institute of America
Dept. RN-2
326 Broadway, New York, N. Y.

Gentlemen: Please send me your big FREE 50-page book which tells about the brilliant opportunities in Radio and about your famous laboratory-method of guaranteed radio instruction at home.

Name.....

Address.....

Please say you saw it in RADIO NEWS

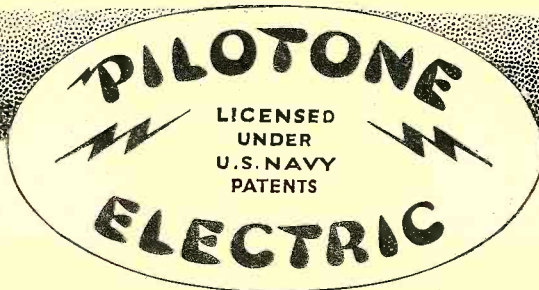

Here's the A-C K'it you've been waiting for.

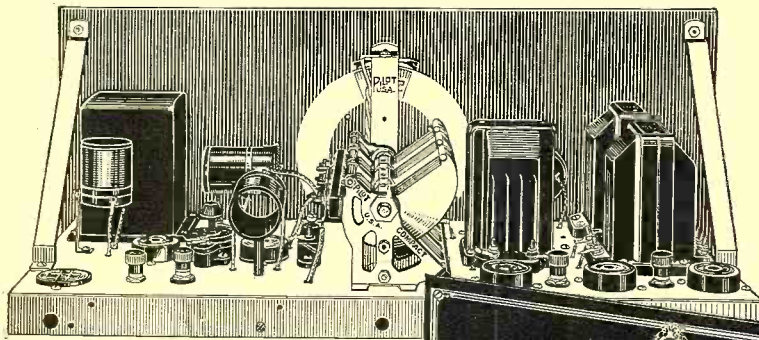

Above—"The Works" showing built-in "A" Power.

At Right — Front Panel, beautiful in its single control simplicity. Standard size 7" x 18" fits all cabinets and consoles.

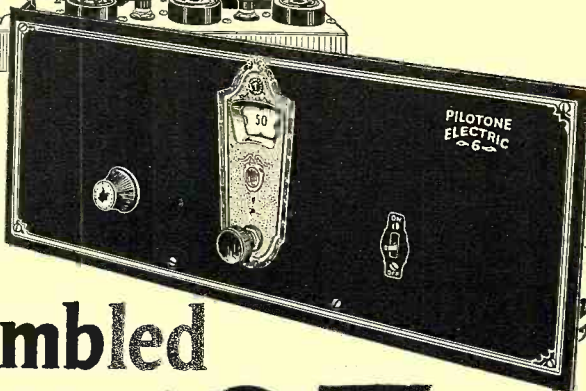

CUSTOM-SET BUILDERS

As rapidly as manufacturing permits, stores are being supplied.

If your local store cannot supply you write us direct and we will see that you are taken care of.



Use this Pilotone "B" Eliminator No. K-107 (designed especially for this receiver) or Pilot "B" Pack No. 5, or any other standard eliminator.



Can be assembled for less than **\$27⁰⁰**

including Built-in "A" Power

Think of it! A 6-tube all-electric receiver with features found only in the most expensive factory-made sets . . . at a price that seems unbelievable . . . all because the Pilotone Kit is produced by the World's Largest Radio Parts Plant! All-Metal construction insures greatest accuracy, ease of construction and professional appearance.

"B" ELIMINATOR EXTRA

Features!

- Latest commercial-type all-metal construction.
- All holes stamped—no drilling!
- Single control, Illuminated Dial.
- No batteries—all electric A-C operation with built-in "A" power.
- Uses all standard A-C tubes which are correctly biased to prolong filament life.
- New compensated triple gang tuning condenser.
- Latest push-pull amplification.
- Simplified construction means simplified assembly.
- Full Size construction Blue Prints furnished.
- Licensed under U. S. Navy Patents.

Full details in current issue "Radio Design Quarterly," published at 103-F Broadway, Brooklyn, New York. Subscription, 50c per year.

PILOT ELECTRIC M'FG. CO

323 BERRY ST. BROOKLYN, N.Y. INC.

TRADE MARK REGISTERED

"WORLD'S LARGEST RADIO PARTS PLANT"

Please say you saw it in RADIO NEWS

Radio News



Hugo Gernsback Editor & Publisher

Editorial and General Offices, 230 Fifth Avenue, New York

Vol. 10

FEBRUARY, 1929

No. 8

The Short-Wave Fan

By HUGO GERNSBACK

WHEN radio was young (and when, as a matter of fact, it was known, not as radio but as "wireless") there was no such thing as radio broadcasting. Radio amateurs were at that time receiving only telegraphic messages from the large radio stations, ships and the like, and you had to know code to understand what was going on.

Broadcasting changed all this and, in 1921, a tremendous radio boom started; soon the whole country went wild about radio, and everybody started to build a set to listen to the radiophone emissions from the various broadcast stations. The nickname of "radio fans" was given those who had built their own sets and were listening in. Later, as the general public became sufficiently interested in radio, the term "B.C.L." (broadcast listener) was coined, and the ordinary set owner is still known under this sobriquet.

History is repeating itself again, and we are now in the midst of what may be termed a small, but rapidly-growing, short-wave boom.

For many years, radio amateurs have been operating below 200 meters—their legitimate field of action—but, of late, the broadcast stations have been invading more and more the short-wave bands; until now there are over one hundred short-wave broadcast stations scattered throughout this country and the rest of the world.

Usually, these stations operate in the same manner as that of the RADIO NEWS stations, WRNY and W2XAL; *i. e.*, two or more transmitters are connected together and what goes out over the long-wave broadcast band goes out simultaneously over the low waveband as well.

The uninitiated do not at once understand that, in order to receive the short-wave broadcast, either they must have a set entirely different from the one they use now; or, if they do not wish to build a new set, there are now on the market (and short-wave enthusiasts can now build them) so-called "converters," wherewith it is possible to listen to the short-wave broadcasts from all over the world on your own regular broadcast receiver.

These converters, while satisfactory in many cases, are not on a par with the separate set built purely for reception of short-wave broadcast emissions.

The uninitiated and the man new to radio often wish to know why it is necessary at all to have short-wave broadcasts. The reason is that, with the average 500-watt broadcast transmitter, such as most of our cities now boast, such a transmitter cannot be heard consistently over a distance of more than about 50 miles. The same power in a short-wave transmitter, however, annihilates practically all mundane distances. Thus, for instance, the RADIO NEWS short-wave transmitter, W2XAL, is heard consistently in Australia, although its power is considerably below 500 watts.

It is this that makes short-wave reception such a wonderful thing, because distances mean nothing, and foreign stations in many cases come in like locals on the longer waves.

The man far removed from the large broadcasting centers can now nevertheless enjoy broadcast concerts by listening-in with a short-wave receiver; and he is just as apt to pick up London or New York as a station a few hundred miles away from him.

There is only one fundamental difficulty with short-wave reception, and that is the so-called "skip-distance" effect. If you are within a few hundred miles of a short-wave transmitter, your reception of this station is not apt to be good; and often it is impossible because of this skip-distance effect. This, however, need not worry you; because many other stations, much further away,

will be found to come in with tremendous volume, if only you have the patience to "fish" for them.

Of course, the tuning operation with a short-wave receiver is quite different from that of the ordinary broadcast set. If you have ever tried to fish for "DX" with your broadcast set, you know that there is sometimes difficulty in holding the distant station, due to the sharp tuning; but, when it comes to receiving stations 5,000 or 6,000 miles away on a short-wave receiver, the thing becomes far more difficult. This is because the tuning is much sharper on the short waves, and the signals more elusive on account of this; but, again, it is nothing but a matter of practice. A little patience and perseverance will quickly make the average broadcast fan efficient in handling a short-wave set.

And as for thrills, the old one-tube set that drew in a distant station a thousand miles away is not at all in the class of a short-wave set, with which distance really takes on a new meaning. 5,000, 8,000, 10,000 miles is an every-day performance with a good short-wave receiver. Of course, such reception cannot be obtained in all localities; because short waves are apt to be freakish, and the reception is not always of such a nature that you can get the same station night after night. The short-wave listener, however, is usually compensated in this; because if he cannot get London, he probably will hear Eindhoven (Holland) or, maybe, some foreign station much further removed.

As a promoter of good will between the various countries, it seems that the short-wave stations in the future will do far more good than all the ambassadors throughout the world.

And the best part of short-wave reception is that a good set is exceedingly low priced. An excellent set can be purchased today for \$50.00; and those who build their own, and can assemble and construct a set themselves, can do so for even less.

Until recently, it was quite the thing to receive short-wave broadcast stations by using headphones only. This was a habit contracted from the old amateurs, but the fashion is quickly passing; and instead of the simple one- and two-tube sets, we now have more advanced receivers, with which the short-wave DX programs can be put directly on the loud speaker for the edification of the entire family. Of course, a pair of phones may be used as an adjunct when hunting for a weak "whistle," but this is not at all necessary.

Short-wave technique is, as yet, in its infancy. Not much about what happens to the radio waves out in space is known; but a good deal of progress is being made. Every month sees the adding of additional important broadcast phone stations, and soon every important station will have its short-wave simultaneous transmissions.

And it looks very much as if, in a few years, broadcast stations are likely to abandon their present wavelengths and there will then be a general exodus down into the short-wave bands. For one thing, on the shorter waves, it will be easier to take care of more broadcasters without cramping them; secondly, in certain regions of the short-wave band, there is less annoying static than in the longer-wave bands.

And, the more short-wave receivers come into use, the more will be known about this phase of the art, and the better it will be for the industry and the public. It is a good thing that the progress from long to short waves is slow and orderly for, if this were not the case, 90 per cent of the present-day radio sets would become at once obsolete. Yet there seems to be no danger of this, as the transition will be quite gradual and will extend over a period of many years.

Mr. Hugo Gernsback speaks every Tuesday at 9.30 P. M. from Stations WRNY (297 meters) and W2XAL (30.91 meters) on various radio and scientific subjects.

How Radio Prospecting Takes the Gamble Out of Mining

Methods by Which Geologists Study the Distribution of Minerals Under Ground Before Digging In

By C. S. Gleason

RADIO waves, projected skyward, have made it possible for a man to see the face of a friend who is at the opposite end of the earth. And now radio waves, directed downward, are enabling man to "see" into the depths of the earth. This new magic is not, however, for every one; but, in the hands of skilled geologists, it is rendering possible the mapping of subterranean regions quite as accurately as surveyors now plot the features of the surface.

More and more the mining industry, once a hazardous occupation in which most undertakings were based upon mere gambler's chances, is coming to adopt the same scientific method which characterizes most industry in the modern industrial world. Before any money is invested in workings in a new area, geologists conduct an intensive investigation into the possibilities of return. Under their direction, a systematic program of "diamond drilling" is generally carried on. "Test holes" are sunk at those points which their knowledge of the geology of the regions indicates as the most promising; and the "corings" brought up to the surface by the hollow drill enable them to determine the nature of the formations below. Not until they have reported favorably is money invested to develop the area. However, these preliminary investigations themselves are very expensive. A good many thousands of dollars may be spent in drilling test holes and, even so, the results are more

or less doubtful, so far as knowing that the corings are truly representative.

Notice to Gold Seekers

FROM our readers, especially throughout the Western United States, and other mineralized regions, countless inquiries about prospecting by radio have been received during the last few years. It is evident that in the minds of the writers, in most cases, there is an idea that it is a simple matter to locate gold and silver deposits in this manner. The present article by Mr. Gleason, describing the most advanced methods of radio prospecting now practiced on a commercial basis, emphasizes not only the complexity of the required apparatus, but especially the need of an expert knowledge of geology. No amount of purely radio experience will enable the engineer to determine the meaning of his results in terms of metals and minerals. We wish to caution our readers that we have on hand no further details of the construction and design of the apparatus described here, and cannot furnish them. Please do not write to this office for them.—EDITOR.



The radio surveyor has to work in many places which are not too comfortable. Minerals did not always seek the most attractive sites to take up their residence, ages ago.

Radio methods make it possible to take a quick and sure survey of the ground, to determine whether or not any ore is present and, if so, its nature. Then, if indications warrant it, test holes can be sunk and samples taken from the veins themselves permit a "quantitative analysis" of the richness of the ore to be made. Thousands of dollars may thus be saved by obviating the necessity of drilling holes in barren territory for the sake of finding a body of ore which, even after it is struck, may prove unprofitable to mine.

RADIO TO THE RESCUE

The principle upon which radio detection of ore is based has long been known; but, because of the complicated technical problems to be solved before the accuracy of measurement could be brought to the point where it is commercially applicable, it is only recently that the successful application has been achieved. A Los Angeles company has spent a number of years in developing a system of prospecting, by radio methods, which bears the same relation to geological structure that topographical surveying does to the surface structure of the earth. Briefly, the method consists of sending out a radio wave in a given direction by means of a transmitter energizing a loop antenna, and noting by means of a receiver, also equipped with a loop, any deflections suffered by the wave as it passes over the surface of the earth. Any conducting body, such as a vein of ore, which lies in the path of the wave, will cause a deviation from the normal indication of the loop; which, as with the radio compass used by ships for obtaining nautical bearings, will ordinarily point directly toward the transmitter.

By measurements and calculations based upon experience, not only are the engineers able to determine the location and the approximate size and shape of the body but, from the information thus derived, in conjunction with other knowledge regarding the geology of the region, they can estimate quite accurately the character of the ore and the location of "fault" lines. A crew of four or five men can survey from eight to twenty-five acres per day, according to the topographical and geological nature of the region. Thus a few days spent in this



Here is a company of radio prospectors snowshoeing over a frozen lake in the north, carrying with them a quantity of their paraphernalia. The large loop is that of the transmitter, and the double hoops are those of receivers. (Photos courtesy The Radiore Company.)

kind of a survey makes it possible to carry on diamond drilling intelligently, instead of depending upon the law of averages to make the few lucky holes pay the cost of those which yield nothing.

DETAILS OF THE APPARATUS

The radio field transmitter (Figs. A and B) consists essentially of a large coil mounted upon a tripod and equipped with a ball-and-socket joint so that it can be swung in any direction. Inside the coil at the bottom, and made a part of the coil case is the oscillator, consisting of two 7½-watt tubes in a full-wave circuit, which oscillates at a frequency of from thirty to fifty kilocycles (6,000 to 10,000 meters), corresponding to wavelengths used in long-distance and transoceanic radio telegraphy. A glass port is provided for access to the inside of the set and also makes it possible to observe the tubes. The whole apparatus is mounted like a surveyor's transit and is equipped with scales so that both "azimuth" (horizontal) and vertical angles can be read. A shoulder-strap is provided for easy carrying; the construction throughout is absolutely waterproof and very substantial—a very necessary characteristic of apparatus which must face the severe conditions met in field work.

Proper plate and filament voltages are obtained from a 500-cycle alternator, the field of which is supplied by three dry cells and the crank of which is turned by hand at a normal speed of one hundred revolutions

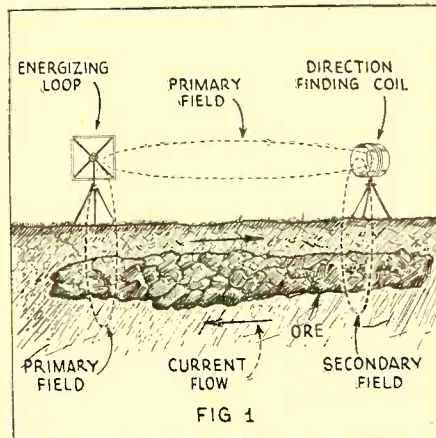

The secondary field induced in the ore body affects the direction-finder and causes a maximum reading away from the direct line to the transmitter.

per minute. The entire power-supply unit (Fig. C) is mounted in a waterproof steel case and is carried separately from the transmitter.

The receiving apparatus consists of two parts which are carried separately: the direction-finding coil, which, like the transmitting or energizing coil, is mounted upon a tripod with a universal movement and vertical and azimuth scales, and the tuning unit, which is enclosed in a steel case provided with a carrying handle and which, when the apparatus is set up for field work, is swung beneath the tripod like a plumb bob. The circuit employs three 199-type tubes, current for which is supplied from dry batteries contained in the case. Tuning is accomplished by means of a tap switch, which controls a series of fixed condensers of values such that the wavelength may be varied in steps between 30 and 50 kilocycles. Finer adjustment is made possible by a small shunt condenser.

The connections are such that the detector may be used as an ordinary stage of audio-frequency amplification when low frequencies of the order of several thousand cycles are employed. The two stages of audio amplification are peaked to favor the characteristic note produced by the 500-cycle plate supply. As may be seen from Fig. D, the recessed panel protects the controls from damage in carrying.

THEORY OF THE SYSTEM

The theory of the direction finder is simple. Radio fans are familiar with the fact that, when a *changing magnetic field* cuts across a conductor, a current is induced in that conductor. Since there is a magnetic field about every wire in which current flows, the flow of current in such a conductor causes it to be surrounded by a secondary field. This secondary field, radiating from the conductor just as if the latter were a second source, naturally alters the distribution of the primary field, reinforcing it at some points and counteracting it at others.

Now, if a loop antenna is connected to a receiving set, a maximum signal will be heard when the plane of the loop passes through the source of the signal. But, if two fields are present simultaneously, the loop will pick up both and will respond, not to either one only, but to the "resultant" of the two. Thus a wave passing over ordinary, fairly non-conducting "terrain," or country, will not be deflected appreciably

from the normal plane. But suppose it encounters a conducting body, such as a vein of ore. A secondary field is induced, which radiates in all directions and thus intercepts the receiver loop. The maximum reading is no longer obtained when the loop is pointed directly toward the transmitter, but at another angle which depends upon the relative values of the two waves.

INTERPRETING THE RESULTS

The method of interpreting the results gained by field observations may be understood by studying Fig. 1. In using the direction finder, the surveyors map out the ground along parallel lines called "traverses," the apparatus being set up on each line in turn. The loop of the transmitter is placed in a vertical plane and pointed along the line toward the receiver. The direction-finding loop is centered upon the energizing coil; the transmitter is started and the receiving operator turns the loop upon its vertical axis until a maximum signal is obtained, just as in taking compass bearings. Now the vertical axis of the loop is locked in this position so that the coil can turn only upon the other (horizontal) axis. The field from the transmitter, extending downward into the ground, induces a current in the ore body, setting up a secondary field which links with the direction-finding coil. Now the direction finder is acted upon by two fields: the primary, coming directly from the transmitter and of course giving a maximum reading when the coil is placed in the vertical plane; and the secondary field, extending perpendicularly to the length of the ore body and therefore at an angle to the first.

This relationship may be better understood from Fig. 2, showing the direction-finder at position A, with the primary field coming toward the reader and at right angles to the plane of the paper. Now the



Fig. A

The portable transmitter used in one system of prospecting. The casing surrounds a large loop. The tripod has vertical and horizontal scales for taking bearings.

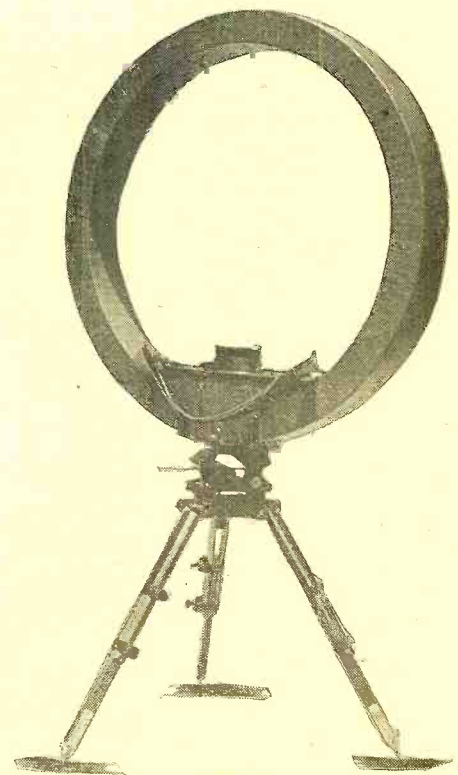

Fig. B

The transmitter set up for use. Its oscillating circuit is in the compartment under the cap in the center.

loop, in its effort to respond at once to both the vertical primary field and the secondary field (which is coming from the right toward the left of the paper) takes a direction which is the "resultant" of the two fields; hence it yields a reading which, as traced by the dotted line, bears directly upon the ore body.

Next the apparatus is shifted to point B and a similar reading is taken, yielding a second bearing upon the ore. When the loop is set up directly over the conductor, as at C, the reading is downward. At points E, F, etc., the deflection is back to the left—always toward the conductor, which is thus definitely located by the convergence of these lines. If such measurements are taken at a number of points along the length of the conductor, a profile map may be constructed showing the actual location of the underground deposit.

MINIMUM-SIGNAL READINGS USED

It might be said here that, although the above diagrams indicate that the direction-finding loop is always turned until a maximum reading is obtained, in practise the readings are actually taken upon the *minimum* instead. This method, as in radio-compass work, also promotes greater accuracy; because the ear is better able to tell when a sound is absent or at a minimum than it is able to distinguish slight degrees of difference in loudness. Readings can nevertheless be recorded as if the bearing were taken upon the maximum, simply by transposing all angles 90 degrees.

Does the radio direction finder tell what kind of ore is present? Directly, no. Since it depends upon a secondary field induced in a conductor, any conducting material—for example, a wet clay seam or a sheet of underground water—may give a reading. Moreover, many ores occur in formations plentifully interspersed with quartz or other non-conductors; so that, though the metallic content of the ore is high, the individual fragments are prevented from actual contact, and the vein as a whole may thus be a rather poor conductor. A condition of this sort may be detected by testing at different wavelengths. Such a sample is shown in the illustration Fig. E. The sections of

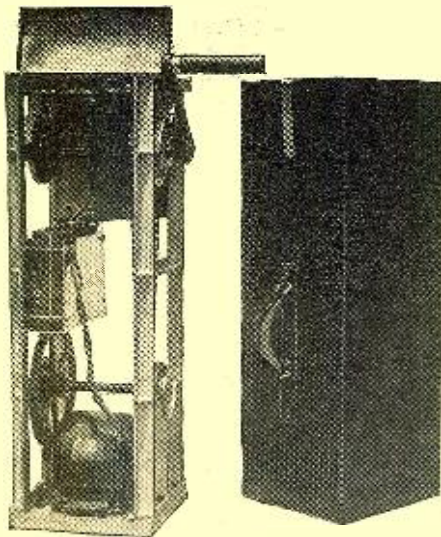

Fig. C

Old Man Armstrong furnishes the power for the prospector's transmitting set whose generator is shown here. It is a man's job to pack outfits like these over rough country, day by day.

ore marked 1, 2, 3, and 4, although sufficiently high in metallic contents to be good conductors themselves, are separated by veins of insulating material so that no direct electrical connection exists between them. However, because of their nearness to one another, these fragments may be thought of as constituting *plates of a condenser*.

As radio fans know, a condenser, although it will not permit direct current to flow through it, will pass alternating current, to an extent determined by the frequency. A piece of ore like the sample therefore presents an electrical circuit similar to Fig. 3. At the high frequencies, such a circuit will be in effect a good conductor. As the frequency is lowered, however, the induced current drops quite rapidly; so that, by varying the wavelength and noting the resulting secondary radiation, the character of

Cap'n Kidd's Treasure

PERHAPS the most persistent question that dogs the waking hours of radio editors is this: "How can I build an apparatus to locate buried treasure? Send diagrams and full information by return mail." In many cases this is inspired evidently by local legends of pirates; in others, confounded with radio prospecting methods described in this article. We have no hesitation in saying that, if we had a semi-magical device for discovering the treasures of the earth and sea, we would not be following the prosaic trade of technical journalism. We also wish to give this answer to our prospective future inquirers: it is possible to locate masses of metal at short distances but not to determine their nature, by apparatus employing a radio oscillator. And a considerable sum in gold or silver, as treasure, is so compact that it would be like the proverbial needle in the haystack to find. Nor will ten thousand dollars in gold distinguish itself from four dollars' worth of lead, electrically or magnetically. We dislike to disappoint any readers who have hopes of spending Long John Silver's doubloons and pieces of eight; but patiently, kindly, and with an air of long suffering, we must ask them not to write to us and ask directions for locating pirate hoards and other hidden fortunes.—EDITOR.

the ore body may be estimated with fair accuracy. A "fault" may present the same condition if (for example) the ore-bearing stratum has slipped upward and non-conducting material has filled the gap between the sections.

CAN WE FIND BURIED TREASURE?

As will be obvious from the foregoing discussion, these methods do not indicate directly the character of the ore itself. But, by comparing the results obtained with his knowledge of the geology of the region, and, perhaps, checking with the "torsion balance" and other geophysical instruments, the mining engineer is able to ascertain within the practical requirements of accuracy the character and location of the ore he is endeavor-

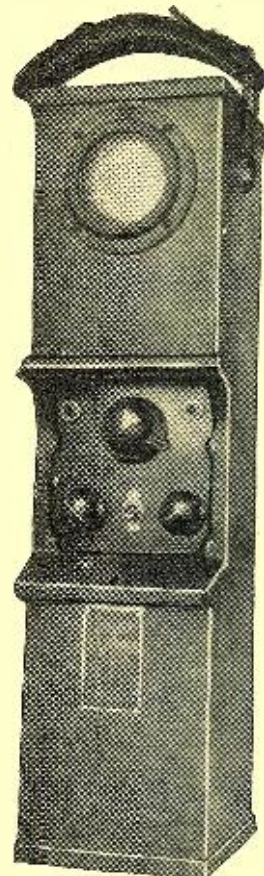

Fig. D

This receiver, looking not unlike an old fashioned wall-telephone, is connected to a small loop and hangs from the surveyor's tripod when in use.

ing to reach. At any rate, the location of the conducting body is certain. If, then, absolute, quantitative knowledge of the mineral constitution of the ore bodies is required, diamond-drill holes may be sunk with the assurance that they will reach the "vein"; all possibility of missing the mark is obviated.

To many people, the question immediately comes to mind, *Will this device locate buried treasure?* Engineers answer this question with a strong NO! Under the conditions usually prevailing where buried treasure is thought to be located, the method described in this article will be of little assistance. It is primarily a scientific system for determining underground mineralization. Its value is to the mining engineer, to tell him where bodies of ore are located and indicate their approximate size and extent; so that he can go ahead with mining operations in the assurance that he is not merely pouring precious dollars into a hole in the ground.

A TASK FOR EXPERTS

It should not be inferred that this radio system renders the geologist superfluous in mining. On the contrary, it places in his hands a tool which makes his work infinitely more valuable, because he can check theory with actual measurement before operations are begun, instead of being obliged to proceed on his findings with the ever-present risk that he is making costly mistakes which can be detected only after it is too late.

On the other hand, the science of the geologist is indispensable to the effective use of the radio equipment; since the proper interpretation of field notes is impossible

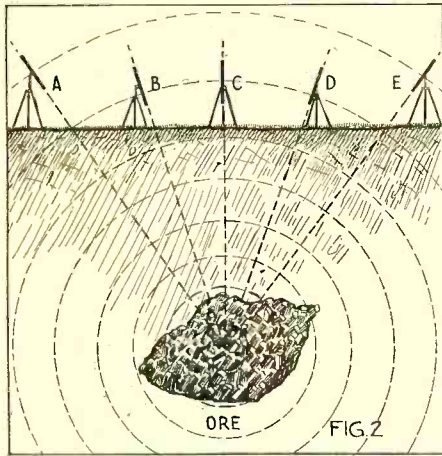

The deviation of the loop reading from the direct line toward the transmitter causes it to indicate the position of ore which affects radio waves.

without knowledge of local geological conditions. Working hand in hand, the geologist and the geophysicist can accomplish what neither could do alone. Not only can they work together for their mutual advantage, but the greater efficiency made possible by their greater success is reflected throughout the mining industry and (as the case with all such advances) the public at large eventually benefits as well. The pure science of yesterday is the applied science of today, and from every new application springs a new benefit to mankind.

EDITOR'S NOTE—THE WAVELENGTH PROBLEM

The difficulties, also, confronting the independent prospector, in availing himself of this ingenious system of locating mineral deposits, are not decreased by the present battle-royal on the part of commercial interests over the allotment of frequency- or wavelength-bands. Hitherto, at least prior to the past year, the depletion of the available unused radio channels, like that of some other natural resources, had passed unnoticed, except by a few experts. Commercial exploitation of the short waves, following amateur demonstration of the practicability of systematic transmission below 200 meters, had been experimental only, and featured as such in the newspapers and technical journals.

In 1928, however, all industries seemed to awake together to the value of short-wave communication; and the rush to Washington to file claims on the utilizable channels recalled the stories of gold discoveries. The telegraph companies, the railroads, newspapers, financial institutions, put

forward their claims to recognition for paramount public service to be rendered. Manufacturers and distributors who sought private radio lines of communication between factories and offices found themselves elbowed into second place. There were more claimants than there were frequency-channels to distribute.

Reckoning up the available wavebands above ten meters, as they had been allotted by the international radio conference, the Radio Commission found that, instead of a surplus, as popularly supposed, there is a famine. Applications were scrutinized with the utmost care, and it became evident that no radio transmission licenses should be granted except with a public benefit in view. With others contesting for an allotment

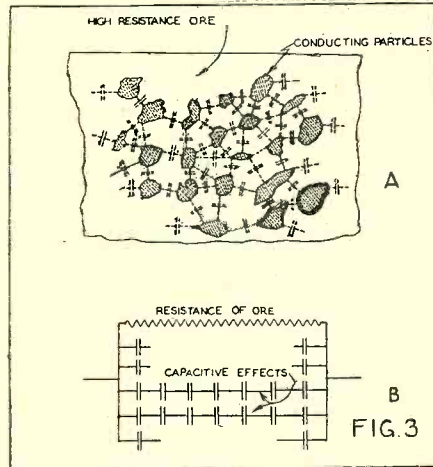

A piece of ore, like that pictured below, is composed of tiny conducting particles set in insulating rock; creating small capacities.

of waves, there recently appeared the representatives of seven companies proposing to enter into the field of radio exploration for oil and other minerals; they enlisted in their behalf the testimony of the Geological Survey, the Bureau of Mines, and the Geodetic Survey as to the value of radio in surveying.

It was pointed out that, while the surface indications of the more accessible portions of the United States have been gone over by geologists, the problem of locating deeper deposits calls for the use of radio. "The continuing discovery of ore, oil and gas deposits is a matter which concerns the public welfare to an enormous extent, and is comparable in its importance to the continuation of transportation facilities. The need of the reservation of powers up to 100 watts is very great and will probably increase with time," it was stated on behalf

of the Bureau of Mines. "Most of the prospecting is done in regions remote from radio interference and therefore offers a minimum of interference."

On behalf of the oil industry, it was urged that better regulation upon a sound business basis could be obtained by radio surveying; rather than by drilling which results in wasteful competition, and depletion of the oil reserves. The issuance of radio prospecting licenses to the applicants was therefore urged as a patriotic measure, in view of the fact that Russian, German, Dutch and other European technicians are using radio in oil surveys, and that the national control of the petroleum reserves yet to be developed is involved.

Five channels, preferably in the vicinity of 200 meters, were requested by the applicants. The Radio Commission took the applications under advisement, pending a conference on short-wave allotments to be held at Ottawa by the official regulatory bodies of the North American countries—the United States, Canada, Mexico and Cuba—to determine on the policy which will be followed.

The situation which has been described above does not seem to hold out much cheer for the free-lance prospector who has been a traditional figure of the West. His opportunity of obtaining a wavelength seems small; and for him to operate an amateur transmitter in the amateur waveband for the purpose—if he had the geological as well as the radio education needed—would be a transgression of the rules, causing interference which would probably be soon detected. Of course, if he were ingenious enough to invent apparatus which he could use in the unallotted, ultra-high-frequency zone below five meters, he would probably get away with it.

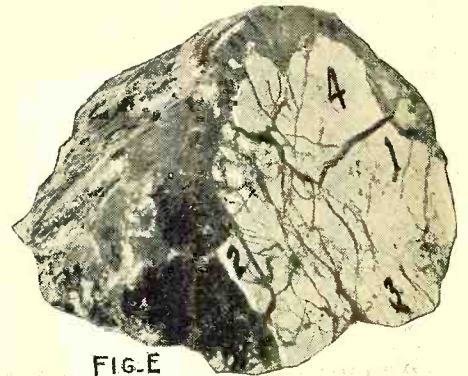

This reproduction of a photograph of a piece of ore shows the little streaks of metallic compounds which set up a counter-action to a radio wave.

What Is Happening in the Television Field?

THERE were practically no new developments in the television field between the time when the January issue of RADIO NEWS was being prepared and the date on which this issue was closed. At this writing, the order of the Federal Radio Commission calling for restricted television broadcasting is still in effect, and no new plans are to be announced until the first of the year. In our March number we expect to be able to report further progress; that is, providing the Federal Radio Commission recognizes the value of experimental television broadcasting and allows it to continue on the broadcast band, as well as on the short-wave bands.

Television Fans!

RADIO NEWS is anxious to obtain from you descriptions of your television apparatus and of the results you are obtaining from stations WRNY, W2XAL, WGY, W2XAF, W2XAD, W1XAY, WIBO, WMAQ, W3XK or any others that have gone on the air recently with television. Drop us a line and let us know what you are doing.—EDITOR.

No new television transmitters have been made public since last month's number; although some of the stations that had announced tentative plans for television serv-

ices are now actually on the air. Of these stations, the most prominent are stations W1XAY, at Lexington, Mass., operating on 62.5 meters, and WMAQ in Chicago, Ill., operating on 447 meters. The RADIO NEWS stations in New York, WRNY on 296.9 meters and W2XAL on 30.91 meters, have been continuing their pioneer television broadcasting without interruption, although the time available for these broadcasts has been reduced.

There has been little activity in the commercial field of television, for the reasons outlined in our last month's number. The outstanding development of the month of (Continued on page 762)

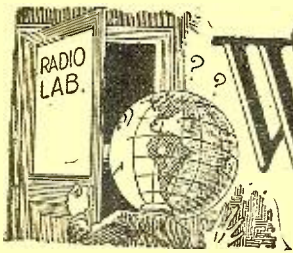

What's New in Radio

All apparatus described in this department has been tested in the RADIO NEWS Laboratories and found of high quality in design and construction.



A Six-Purpose Light-Socket Fixture New Arrival

AN all-purpose light-socket appliance, which seems to have a knack of "doing things" in liberal quantities and with some gusto, has just been developed by a Mid-Western manufacturer. This versatile accessory is obtainable in the form of a compact aluminum case, measuring $4\frac{3}{4}$ x $3\frac{1}{2}$ x 2 inches, which has mounted upon its top two spring-clip binding posts, two receptacle outlets, and a knob which controls a rheostat within the case. A six-foot silk cord, provided with a hand switch, furnishes the means of connecting this unit to the light socket. (Fig. A.)

The duties of the various components which are part of this unit as outlined above, are as follows: the two spring-clip binding posts are connected to the two sides of the house-lighting mains through small fixed condensers, thus furnishing both "aerial" and "ground" connections for the receiver. The two outlets are provided for "A" and "B" power units, if used; only one need be used for this purpose with an A.C. electric receiver, leaving the other available for any appliance for which a receptacle is desired. A power rheostat, placed in series with the input line, serves as a voltage regulator and protects the power apparatus and tubes of the set from overload caused by variations in line-voltage. The unit is equipped with a fuse, as specified by the fire underwriters, which automatically opens the 110-volt line, should any part in the receiver or unit break down.

Manufacturer: X-L Radio Laboratories, Chicago, Ill.

Photoelectric Cell Employs Unique Principle

A LIGHT-SENSITIVE cell, of a type heretofore unfamiliar to the average radio experimenter, is being marketed by a New York corporation in two forms, as shown in the photograph reproduced herewith (Fig. B). The cylindrical component

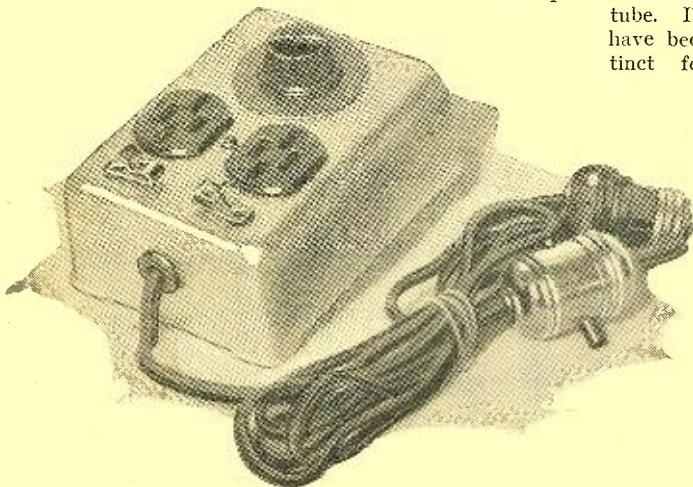

Fig. A

The all-purpose lighting receptacle, power supply and antenna described above. Every external connection of a receiver is here provided for.

at the left of the aluminum-encased unit is the "photo-voltaic" cell in a glass tube measuring 4 x $1\frac{3}{4}$ inches; it consists essentially of a copper-alloy electrode with a colloidal film thereon, and a leaden-alloy electrode, which are separately immersed in an alkaline solution and brought out to two binding posts. This construction gives the cell the appearance of a small storage battery cell.

The assembled unit shown at the right contains, as the "heart" of its assembly, a cell similar to that described above, and includes also a sensitive galvanometer-relay, a biasing resistor to control the sensitivity of the relay, and a small "C"-type battery. The trap-door in the top of the case serves as a shutter when it is desired to expose the cell to light, or to prevent the relay from functioning, as the case may be. The outside measurements of this unit are $5\frac{1}{2}$ x $5\frac{3}{8}$ x 4 inches.

Aside from the field open to the experimenter for a good deal of interesting research work, the cell in its assembled form

The unit at the right is an assembly comprising a cell like that at the left with a relay (which makes contact on the meter dial) and controls. The door in the top admits light to the cell, when open.

has innumerable practical uses; such as ringing a burglar-alarm or a fire-alarm, shutting a window, starting a furnace or an electric heater, lighting a fire, or any of the numerous functions which are usually brought about manually with the coming of daylight or of darkness. The commercial value of light-sensitive cells has long been known and, in fact, is being utilized at present by many industries.

Photoelectricity has, in the last ten years, become a specialized study in itself, as with the operation of the three-element vacuum tube. During this period there have been catalogued three distinct forms of light-sensitive cells, in each of which the phenomena are different. The first is classified as the actino-electric or photo-resistive type; this cell consists of a metal or compound to which there is connected a

source of potential. On the exposure of the cell to a source of light it will exhibit a change of resistance, thus affecting the flow of current across its terminals. Cells of this type, most commonly using selenium as a light-sensitive resistor, have been in use for many years.

The second type, which is perhaps most familiar to the experimenter because of its use in television and the consequent publicity it has received, makes use of the photoelectric effect; in this a film of an alkaline metal is deposited on the inner surface of the glass of a vacuum tube, and

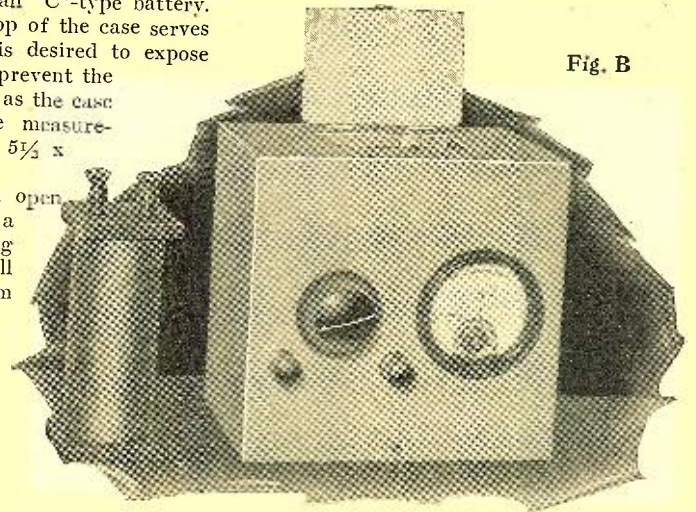

Fig. B

a centrally-fixed "collector" is placed in the center of the bulb so that it faces the "coating." When the cell is exposed to a source of light the alkaline metal emits electrons in much the same way as the heated filament in a vacuum tube; only, in this case, the emission of electrons is caused by light instead of heat. Thus, it can be seen, in this cell the circuit is closed through the electrical path provided by the flow of electrons from the alkaline coating to the central "collector."

The third classification is that of the cell described in this article, which exhibits the photo-voltaic effect. In this case a source of potential is obtained as the result of exposing to light one of two plates immersed in an electrolyte. The voltage created across its terminals is the result of chemical action on the plates, which varies with their exposure to light. This voltage is then employed to actuate a sensitive relay, which in turn actuates another relay; the terminals of the latter are brought out to the two binding-posts on the front of the case, and whatever apparatus is to be operated is connected to these binding-posts.

An item of interest in connection with this cell is a statement of the manufacturer to the effect that the exact nature of its functioning is yet open for discussion. Many prominent electro-chemists and phy-

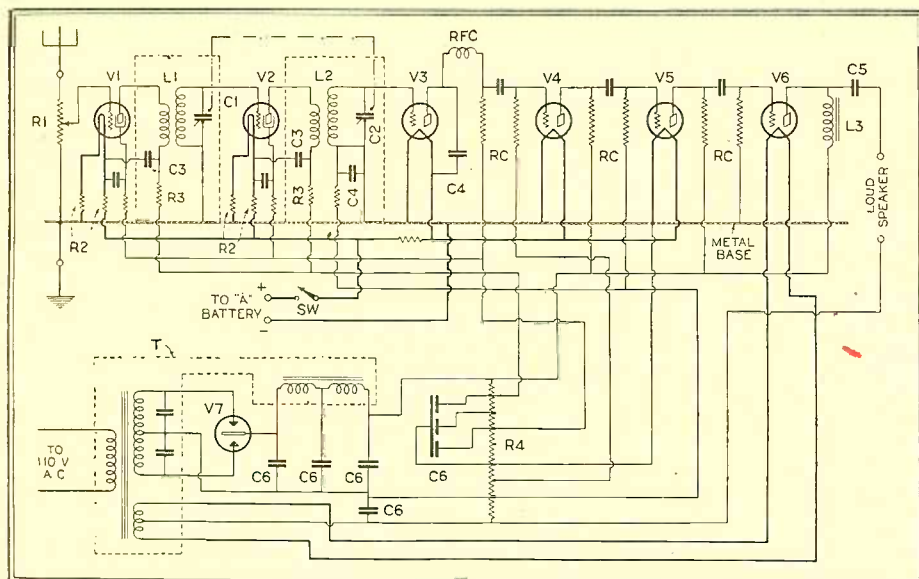

Fig. 1

This is the circuit of the six-tube receiver shown below, with its incorporated power unit. The two screen-grid R.F. stages and first hi-mu audio give enormous sensitivity.

sicists have been consulted, but no agreement has been obtained on the theory of the effect of light in the chemical and consequent physical phenomena. The exact nature of the alloys and of the electrolyte is still withheld by the manufacturer, pending patent action; it is stated, however, that alloys are used to prevent deposition of one metal on another, and precipitation.

Manufacturer: Radiovision Corporation, New York City.

A Screen-Grid R.F. Kit for the Custom Trade

APPEARANCE, though unessential to the successful operation of a radio receiver, is a valuable asset in its sale, as the commercial development of the industry has abundantly proved in the last few years. To the custom radio builder, therefore, it is a vital matter; and this fact is fully realized by today's parts manufacturers. Kit design has kept fully apace with that of factory-assembled sets—as in circuit refinements it has been always slightly ahead. The accompanying photographic illustration (Fig. C) of a new arrival in the radio market exemplifies this trend to elegance as well as efficiency in apparatus for home construction; the co-operative effort of a group of manufacturers has made the set of components available in complete form. Several allied models have been produced, classified as "master" and "junior"; the latter, a very compact receiver, elegantly housed, is pictured here. It is supplied with a "foundation unit" or chassis of heavy aluminum, and a front panel of bakelite, both already drilled to receive all parts which make up the receiver; the assembly of this apparatus is therefore a matter merely of securing the parts to the chassis and the front panel, and wiring.

The model described herewith is obtainable in two circuit designs—one employing A.C. tubes and the other battery-operated. The latter (which is illustrated here) should rightfully be termed "semi-battery-operated" because of the inclusion in the assembly of the "B" and "C" power unit, thus necessitating only the addition of a storage battery for filament lighting. The front

panel, which measures 7 x 21 inches, mounts the volume-control knob, the escutcheon plate for the drum dial, the knob operating the two tuning condensers, and the filament switch. Upon the aluminum foundation unit, which measures 20 x 12 inches, are mounted the components of the receiver, as well as those which make up the "B" and "C" power unit. The receiver (whose schematic circuit diagram is Fig. 1) utilizes six tubes of "storage-battery" types (in addition to the gaseous-rectifier tube used in the power unit) which function as follows: one screen-grid (222 type) tube as an aperiodic antenna coupling stage, V1; another screen-grid tube for the following stage of tuned-radio-frequency amplification, V2; a 201A type for the detector socket, V3; and three stages of resistance-coupled amplification, of which the first tube, V4, is a 240 type, the second, V5 a 201A type and the third, V6, a 171A type.

The first screen-grid tube is used to isolate the antenna from the first tuned circuit and thus make possible simultaneous efficient control of both the detector and tuned-

radio-frequency stages, without the need of a manual control to compensate the varying characteristics of different antennas. The coils used in the radio-frequency amplifiers, L1-L2, incorporate primaries specially designed for screen-grid circuits. These are only 1½ inches in diameter and have a great number of turns of very fine wire; they are tapped, thus making it possible to vary the operating characteristics of the receiver to suit most effectively local conditions.

It will be noticed that a grid leak and condenser are not employed with the detector tube, but this circuit is arranged for "plate rectification." The audio-frequency amplifier incorporates three resistance-coupling units RC; each of them comprising a grid and a plate resistor and a .005-mf. fixed condenser. A high-mu tube is used in the first stage of the amplifier, and in the third and last, a power tube which receives its filament supply from a 5-volt step-down secondary of the power transformer. A combination of a choke coil L3 and a by-pass condenser C5 prevents the high current of the power tube from passing through the windings of the loud speaker.

The tuning circuits are completely shielded by aluminum cans (indicated by dotted lines) of special design, to prevent coupling between them. This precaution is a necessity where screen-grid tubes are to be used at maximum efficiency and all causes of feed-back must be eliminated. The separate-stage shielding accomplishes the major part of this necessary isolation and in addition, the screen-grid terminals of the tubes are by-passed to the filaments to minimize coupling. Also, separate filters are used in the plate circuits of both screen-grid tubes; these filters consist of the 5000-ohm resistors R3, and the 0.5-mf. by-pass condensers C3.

The shielding of the screen-grid tubes has been handled in a simple manner. Placing them in the shield cans would necessitate individual tube shields to isolate their elements from the other apparatus. To obviate the use of these additional shields the tubes are placed outside the stage-shields, in such positions that their control-grid and

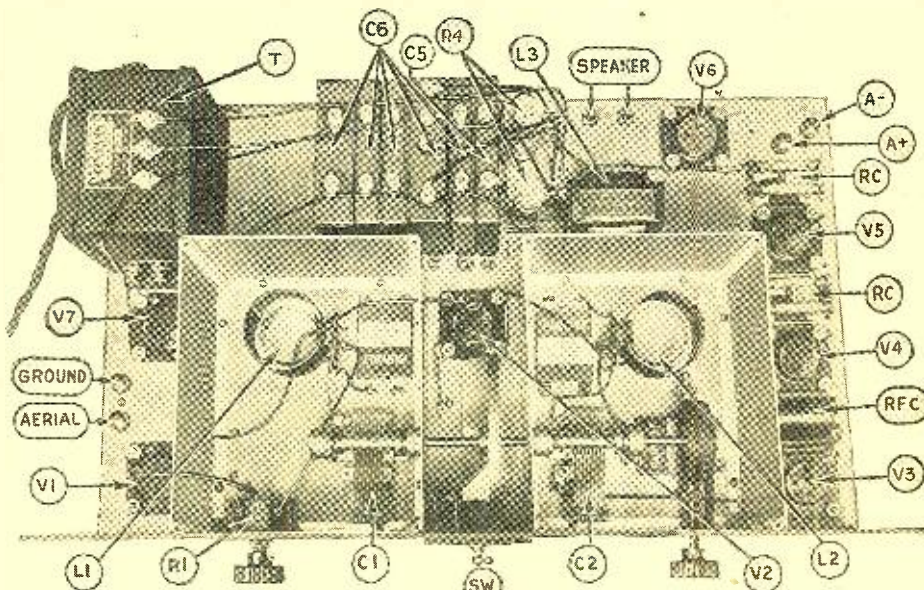

Fig. C

This receiver when assembled on its ready-made foundation and panel is very compact; its panel with single scale is symmetrical and attractive. The tuned circuits are completely shielded.

plate leads are very short; and coupling between the tube elements and other parts of the circuit is practically negligible.

Control of volume is accomplished by the insertion of the 3000-ohm potentiometer R1 between the aerial and the ground. The slider-arm of this component is connected to the grid of the antenna coupling tube V1; thus allowing any desired proportion of the signal voltage across the resistance strip to be impressed on the grid of the first tube. The special tapering of this strip gives a rate of variation which is under better control at the lower volume settings and makes operation less critical.

The lower section of the schematic diagram (Fig. 1) shows the "B" and "C" power unit; while in the illustration (Fig. C) the components which make up this assembly can be seen mounted behind the shield cans. This unit comprises a power transformer and the necessary choke coils and buffer condensers; together with a bank of filter condensers and a series of resistors which reduce the output of the unit successively to the various potentials necessary for the successful operation of the receiver. The gaseous-rectifier tube (filamentless type) V7 is employed in the rectifier circuit of the unit.

The loud-speaker terminals are inserted into two phone-tip jacks which are mounted at the rear of the chassis; these are colored distinctively red and black, so that the proper polarity may be applied to the speaker's winding.

The A.C. model of this receiver differs from that described and illustrated here only in that a step-down transformer is added, to allow the use of 15-volt heater-type A.C. tubes.

Manufacturer: Hammarlund-Roberts, Inc., New York City.

New Short-Wave Adapter Unit Easily Attached to Set

THE short-wave adapter unit illustrated herewith is marketed by its designer, a New York City manufacturer, who is well known as a producer of inductance coils for

the radio industry, as well as for contractors' use. The converter measures 8½ x 6 x 5¼ inches, its components being housed in an all-metal cabinet which is finished in a walnut-grain effect.

Five coils of the plug-in type provide a wavelength range of from 15 to 550 meters, divided as follows: 16 to 32 meters; 29 to 58 meters; 54 to 110 meters; 103 to 210 meters; and 200 to 550 meters. It will be noticed that the coil ranges indicated overlap, thus eliminating the possibility of gaps in the tuning range. These coils are wound on molded bakelite forms, and use for a mounting base a standard UX socket. This is set into the top of the cabinet, directly behind the other UX socket, into which the tube is inserted.

The circuit employed is a straight regenerative one; there is fixed coupling between the grid coil and the tickler winding, and the regeneration is controlled by a .00015-mf. variable condenser (C3) which is connected between the "P" terminal of the coil socket (which connects to the tickler winding) and the filament return circuit.

The operation of this converter unit is very simple; the .00015-mf. variable condenser C1, which is connected across the grid coil, is the only wavelength control. The .00002-mf. midget variable condenser C4, which is used to couple the grid to the aerial, has its knob on the top of the cabinet and, once adjusted to the characteristics of the antenna used with this unit, remains fixed.

In order to adapt this unit to any broadcast receiver, the owner must disconnect the aerial and ground from their binding posts on the latter and connect them to the

"Aerial" and "Ground" posts of the converter unit. Next, the detector tube of the broadcast receiver is removed from its socket and replaced by the adapter-plug of the converter unit. The tube which was removed from the larger set is then inserted into the front tube socket on the cabinet of the unit. The set is then ready to operate. It should be remembered that phones should be substituted for the loud speaker; because, while tuning, signals received on the short waves rarely possess anything near the volume of those on the broadcast bands.

An A.C. model produced by the same manufacturer is exactly the same in circuit and design as the D.C.-tube model described above except, of course, that its filament circuit is designed for the 227-type five-

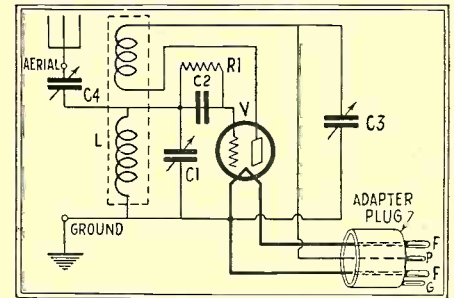

Fig. 2
Circuit of the short-wave adapter unit.

prong, A.C. detector tube. The method of adaptation and operation with an A.C. set is the same as that followed when using the D.C.-tube model.

Manufacturer: Dresner Radio Mfg. Co., New York City.

Fig. E

Right, the converter unit, as the inside appears from below. All parts are mounted on panel and top.

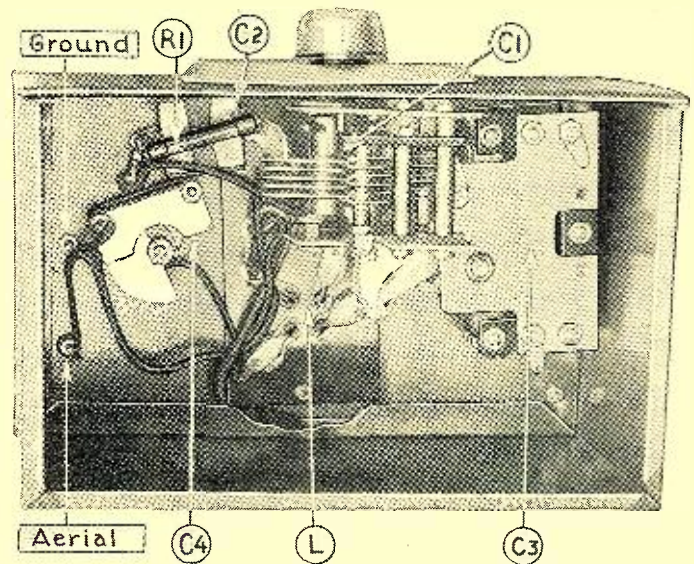
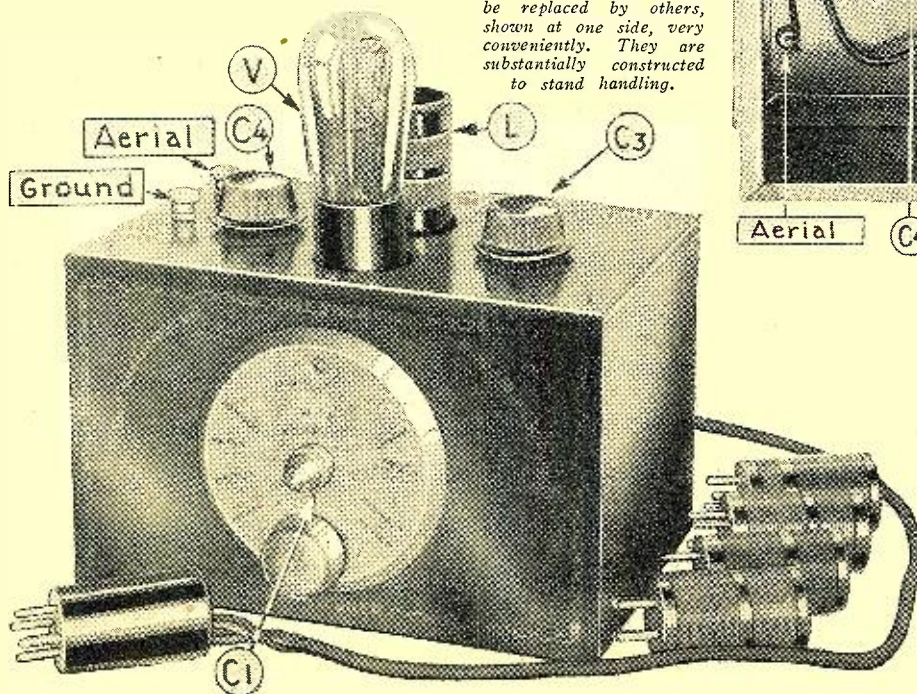

Fig. D

The attractive case of the unit. The coil L1 may be replaced by others, shown at one side, very conveniently. They are substantially constructed to stand handling.



Substantial Condenser Gangs for Set Builders

UNUSUAL strength of construction is the characteristic feature of the multiple tuning condenser illustrated in Fig. F, which is now being marketed by a New York manufacturer, and which is the latest response to the demand for adequate single-control of the tuned radio-frequency stages of a receiver. For this purpose it has been designed in six models—double, triple and quadruple combinations in the two standard sizes—offering the choice of .0005-mf. and .00035-mf. pairs. The rotor plates are cut

(Continued on page 760)

The subject of tuning and resonance in alternating-current circuits has been covered in many articles in *RADIO NEWS*; that by Clyde A. Randon in the January, 1928, number describes the phenomena obtained in popular language. This is not a suitable place to consider the problem mathematically; but it may be explained that, while both inductance and capacity offer opposition to the flow of alternating current, these effects cancel each other; and, where they exactly balance, *resonance* is obtained.

For instance, at an alternating-current frequency of 600 kilocycles, corresponding to the carrier-wave of a 500-meter broadcast station, a condenser of .0005-mf. capacity has a *reactance* to the current of about 530 ohms. At this same frequency a coil of 141 *microhenries* effective inductance has the same reactance; and, if the coil and the condenser are connected across each other, the circuit which they form will have almost zero resistance to a 500-meter alternation. At any other frequency, however, the reactance of this tuned circuit will be considerable; and it therefore is sensitive only to signals of the desired wavelength, and those impulses not further from it than the broadcast "sideband" requires. It is to be noted that this energy in a resonant circuit goes round and round in it—it does not pass through.

THE MICROFARAD

At this point the reader may ask (as many do), "What is a microfarad? What do mf. and mfd. mean? Are they the same as mmf.?"

The explanation may as well be given here. The unit by which electrical capacity is measured is the farad, named in honor of Michael Faraday, a great scientist. It is the capacity which under one volt pressure will take up enough electricity to maintain a flow of one ampere of current for one second. That sounds like a very small capacity; but the fact is, it is most enormous. A condenser with *one one-millionth* of that capacity is a good-sized one. We call one one-millionth of a farad a *microfarad*; the word is abbreviated mf. or, sometimes, mfd. Scientists prefer to use the Greek letter "mu" for "micro"—a Greek prefix meaning *very little*—but it is unsuitable for general use.

A *microfarad* is a suitable unit for rating radio apparatus used in low-frequency circuits, such as those which rectify 60-cycle house-lighting current, and even those carrying musical and speech frequencies up to 5,000 cycles; but it is rather large for a circuit which is tuned to radio frequencies. The most used sizes of tuning condensers are .0005-mf. or one two-thousandth of a microfarad, and .00035-mf., or seven twenty-thousandths of a microfarad.

Another unit is therefore in use for measuring more conveniently the very small capacities. A *micromicrofarad* is one one-millionth of a microfarad, or one one-trillionth of a farad. It is abbreviated mmf. or sometimes mmfd.

One microfarad is 1,000,000 mmf.; as .001-mf. is 1,000 mmf., so .0005-mf. is 500 mmf. and .00035-mf. is 350 mmf. Below .0001-mf., it is customary to speak of the very small capacities in micromicrofarads; for instance, the capacity between the elements of an ordinary vacuum tube is about 9 mmf. (Radio amateurs sometimes call the "micromike" a *picofarad*, for brevity's sake.)

At six volts, we can charge about 100

ampere hours into a good big storage battery; if we had a sufficiently large condenser, we could do the same. But we would require 60,000 farads capacity, or sixty billion one-microfarad condensers hooked together in parallel; and the voltage would fall rapidly as it discharged. So it is not probable that the use of condensers will supersede that of storage batteries for some time to come. (It may be explained that the energy stored up in a condenser is proportional, not *directly* to the voltage applied, but to the *square* of the voltage. That is, at 100 volts a condenser holds 10,000 times the power that it will at one volt.)

CAPACITIES OF CONDENSERS

The amount of capacity between two metal plates separated by air may be judged from this example: two sheets, each 10 inches square, and uniformly one-tenth of an inch apart, give almost exactly 225 micromicrofarads (.000225-mf.). The capacity increases or decreases in proportion to the area; it *decreases* proportionately as the distance between the plates *increases*, and *vice versa*. It varies with the nature of the insulator or dielectric between the plates; oil, for instance, gives a very high capacity. In the "electrolytic" condensers, where the metal plates form one conductor of the condenser and the liquid or electrolyte the other conductor, the dielectric is a film of gas less than a thousandth of an inch thick; and an enormously high capacity is obtained.

The article, "What is The Life of a Fixed Condenser?" in *RADIO NEWS* for July, 1928, discusses the actions which take place in a condenser, and the function of its dielectric, at more length. Another article of interest will be found by the reader in the June, 1928, issue—"The How and Why of Radio Filters"—and, if he has preserved a file, it will be of interest to turn to page 804 of *RADIO NEWS* for January, 1927, and read "Some Facts About Condensers." That article is illustrated profusely with illustrations of both fixed and variable condensers. Since that time little progress has been made in the design of the variables; but the tendency has been toward the more general use of the smaller tuning condensers with specially-shaped plates distributing stations more evenly on the dial, in the case of broadcast receivers. The tendency toward

operation of several condensers by one knob, instead of having a separate control for each, has governed commercial design for the past three years. It adds greatly to the convenience of the user; though it reduces the efficiency of the receiver on distant signals, unless convenient methods are provided for operating small "compensating" or "trimming" condensers.

VOLTAGE RATINGS

In the field of fixed condensers, the introduction of power units operated from the lighting circuit, and the popularity of power tubes requiring from 180 to 500 volts of "B" potential on their plates, have made necessary the use of "by-pass" condensers designed for high voltages. These were previously used by designers of transmitters and other high-voltage apparatus; but came as a new thing to receiving-set builders. It is to be remembered that, while a direct-current voltage represents a constant, steady pressure, the figure which we use for an alternating-current voltage is an *average* which is greatly exceeded twice in each cycle. That is to say, a 110-volt A.C. line carries 155 volts at regular intervals which occur 7,200 times a minute. When the alternating current is stepped up by the transformer of a power unit to a nominal 750 volts, it actually rises to 1060; and even higher, when what are called "surges" are created in the line. It is necessary, therefore, to have in such condensers a dielectric which can not be punctured by very high voltages; for, if a spark once leaped through, the condenser would be short-circuited and instantly burned out.

The electrolytic condenser also, from a mere laboratory device, has become a commercial product of great importance. As explained above, it is capable of containing a very great capacity in a very small space, and because of this characteristic is very popular among manufacturers and experimenters. We have now not only wet electrolytic condensers, which resemble somewhat a storage battery, but even "dry" condensers, which are similar to the dry "rectifiers," and have also high capacity.

REACTANCE OF CONDENSERS

Because an alternating current is not a continuous, one-way flow, such as we obtain

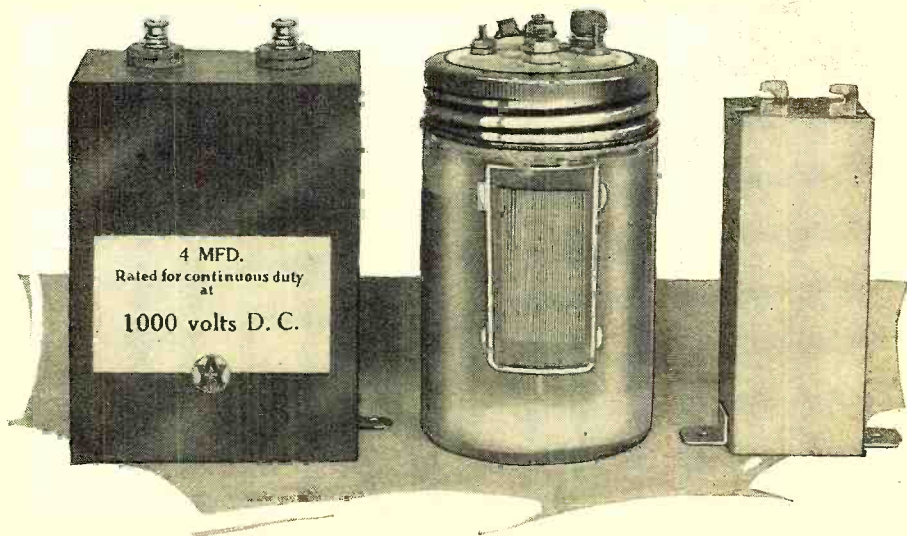

These condensers are for use in connection with power equipment. The jar in the center is an electrolytic 30-mf. condenser. The 4-mf. by-pass condensers at right and left differ in the thickness of dielectric used to separate their plates, and consequently in bulk.

from a battery, it is possible to connect a condenser in such a way that alternating current will flow alternately into one set of plates and into the other; and, if the capacity of the condenser is proportioned correctly to the frequency of the current, the effect is just as if the current were flowing through the condenser. This is not fully true if the condenser is too small, or fills with electricity too fast. In other words, the longer the period of an alternation, the larger a condenser must be to hold the electricity poured into it during that instant by the pressure of a given voltage. So we say that, the smaller the capacity of a condenser, the greater its reactance to an alternating current; and, the longer the period of alternation (the fewer the cycles) the greater the reactance of a condenser. These are two ways of stating the same fact.

So, if a condenser is across a steady, direct current, it neither receives nor discharges electricity; it remains stored to its capacity at the impressed voltage, but inactive. The current does not pass through it, but is "blocked." If, however, there is a pulsation in that current, it is felt through the condenser, and there is a flow of current in and out of both sides of the condenser; which is commonly described by saying that the A.C. flows "through the condenser."

For that reason, condensers are used in radio receivers, which contain many complex circuits with both alternating and direct-current components, to separate the latter; as well as to tune other circuits to certain frequencies.

APPLICATIONS OF CONDENSERS

For instance, let us consider Fig. 1. In the aerial circuit we have the condenser C. It "shortens" the aerial; that is to say, it tunes the primary coil to a shorter wavelength by cutting down the effective capacity of the aerial itself, though the impulses impressed on the aerial are transmitted to the coupling coil.

The condenser C1 is a large one, however; too large to affect the tuning of the circuit noticeably, for reasons which will be explained later under the subject of capacities in series. It cuts off the possibility of a short-circuit through the metallic ground system to the light lines, perhaps.

The variable condenser CV tunes the secondary of the aerial coil. If it is connected by a mechanical coupling device to CV2, which tunes the next stage, the addition of the "compensating condenser" CV1 may be necessary to make both tuning condensers read alike at all points on the dial.

The neutralizing condenser C2 is of very small capacity. It overcomes the tendency of the first R.F. tube to oscillate through its internal tube capacity (between filament and grid), by feeding back impulses which exactly oppose the tube feed-back.

The grid condenser C3 charges with the negative electricity thrown off from the filament of the detector tube to its grid, and discharges through the grid leak connected across it; thus automatically regulating the "bias" of the grid. It affords also a low-resistance path for the signal impulses from the preceding tube. It is usually of .00025-mf. capacity.

The purpose of C4 is to allow the radio-frequency impulses in the tickler (plate) circuit of the detector to find their way back to the filament and to ground without passing through the high plate resistor. In some regenerative receivers, a variable condenser is used in this position to govern the amount of feed-back.

"BY-PASSING"

C5 is a simple "by-pass" condenser; it "smoothes out" the radio-frequency impulses in the "B" amplifier circuit and keeps them out of the battery. C6, C7, and C8 may be called either "blocking" or "coupling" condensers; depending upon whether we consider them with relation to the "B" battery current, or to the A.F. signal impulses which they allow to go from the plate of one tube

to the grid of the next. They may be from .006-mf. up. C9 by-passes the "C" battery of the last stage, and C10 the loud speaker across which it is put, thereby keeping high frequencies out of the speaker windings.

In the "B" power unit shown in Fig. 2, the condensers C1 and C2 are "buffer" condensers, usually 0.1-mf., but of high-voltage rating, to take up sudden impulses in the circuit of the rectifier tube. The others are by-pass condensers of 1-mf. or more capacity, but progressively lower voltage requirements, successively "smoothing out" the current delivered to the various stages of the receiver.

By-pass condensers, if over .006-mf. in capacity, usually employ a dielectric of oiled, waxed, or otherwise treated paper in several layers, separating two long strips of tinfoil, each of which forms one "plate." Below .01-mf., the fixed condensers are commonly molded for better protection into a strip of bakelite which is equipped with terminals for connections.

The increasing use of condensers in radio receivers has remedied a great many of the troubles which were experienced in the old days from capacities which were not included in the design—those formed, quite unintentionally, by the charged wires and other insulated-metal parts of the set. In addition, the "low-loss" coils which use air as much as possible for insulation have a lower self-capacity, and consequently tune over a wider range at very low wavelengths than those which are wound on a material whose dielectric constant is high. However, the importance of this may be exaggerated.

COMBINATIONS OF CONDENSERS

Looking at Figs. 3 and 4, we see that when two condensers are connected in parallel, they form, practically, one condenser. Each of the two sets of plates is separated by dielectric under the same voltage and, if the connection is direct between them, and not of high resistance or inductance,

(Continued on page 766)

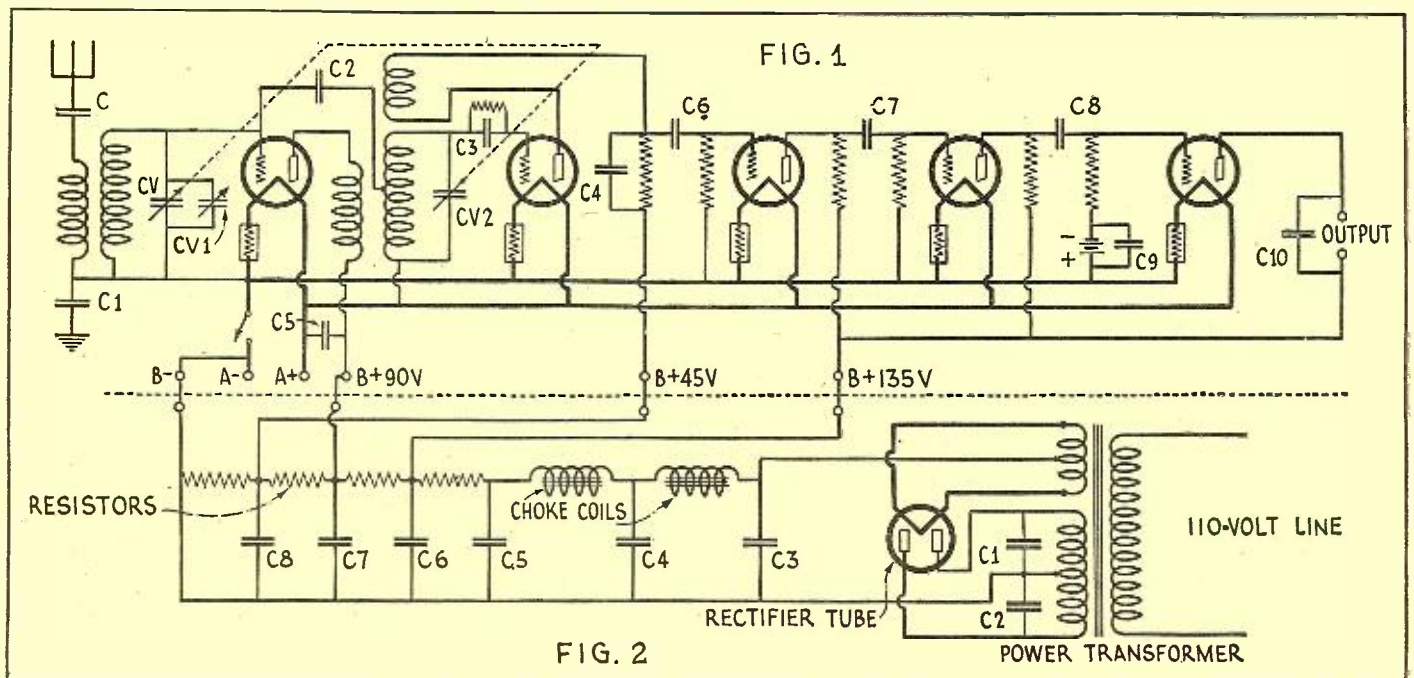

In Fig. 1, above, typical places for the insertion of condensers in a receiver circuit are shown. (This is not a working diagram!) C "shortens" the aerial; C1 protects against a short-circuit of the power unit; CV and CV2 tune the set; CV1 "trims" CV; C4, C5, C9, C10 "by-pass" high-frequency im-

pulses; C3, C6, C7, C8 are coupling condensers, and C3, in particular, is called a "grid" condenser. In Fig. 2, below, C1 and C2 are "buffer" high-voltage condensers, and C3 to C8 inclusive are by-pass condensers of various ratings, depending on the voltages to which they are exposed.

OUTDOOR AND INDOOR AERIALS

HOW THEIR
SIGNAL PICK-UP
QUALITIES
DIFFER

by

Baron

Manfred von Ardenne

Berlin

No subject arouses more interest than the discussion of the respective merits of antenna systems; and on no subject in radio is less reliable, definite information obtainable. This distinguished German experimenter has been making some measurements to determine just how much amplification must be added to compensate for the lessened voltage pick-up of indoor aerials and loops.

IN modern broadcast reception, indoor aerials are being used more and more, particularly in large cities; and, when speaking of indoor aerials, we must distinguish between *open* aerials and "loops." The open (indoor) aerial is generally a length of insulated wire strung about the room; one end is connected to the "Aerial" post on the radio receiver, while the other is taped and left unconnected. The "loop aerial" consists of a number of turns of insulated wire on a square, diamond-shaped, or round frame. The efficiency of either type depends to a certain extent on its length; the radio-frequency signal voltage available at the ends of a loop varies with both the dimensions of the loop and the number of turns of wire on it.

It is generally known that indoor aerials are much less efficient than those erected outdoors; but it is not always understood how the average R.F. potentials, obtained from aerials of different kinds, compare. These figures are especially interesting, because they show how much more amplification must be used with an indoor aerial of one or the other type, in order to get the same strength of signal as with a good outdoor aerial. By measurements, which were carried out with the help of a special aperiodic amplifier in the laboratory of the author in Berlin, the following potential values were obtained at a distance of about five miles from a nine-kilowatt broadcast station.

OUTSIDE AERIAL STANDARD

A large outdoor aerial of the inverted "L" type, with a length of about 75 feet, and erected on the roof of a three-story house, was used as the basis for the measurements; this represents the average aerial for receiving broadcast programs. With another aerial, which consisted of a wire about 33 feet long stretched at the height of the second story, there was obtained a radio-frequency potential only about 1/6 of that available from the first aerial.

Measurements with "loop aerials" of va-

rious sizes were carried out, with the loops directed towards the broadcast station for maximum response and tuned with a variable condenser. The figures obtained show that a loop about three feet on a side gives about one-twelfth as much potential as a good outside aerial; this large loop is marked C in Fig. A. A loop of one-half the width and height (shown at A, Fig. A) of the same inductance value, gives only about one twenty-eighth of the response of the outside aerial; while a 50-turn basket-weave coil (B, Fig. A) gives only *one six-hundred-and-sixtieth* as much signal voltage as a good outside aerial.

WHAT THE FIGURES MEAN

These figures indicate that with the small coil, B, we must use six hundred and sixty times more radio-frequency amplification than with an outside aerial, in order to get the same signal intensity from a station at a given distance. The factor of radio-frequency amplification which can be obtained with a single vacuum tube lies between eight and twelve, on the average. When a screen-grid tube is used, the practicable degree of amplification per step runs to twenty, or as high as thirty. Adopting these values, it will be easy to calculate how many more stages must be employed in the radio amplifier with an indoor aerial. With but a small loop, according to the data given, one or two well-designed stages of R.F. amplification will suffice to give the same sensitivity of reception as with an outside aerial with which no R.F. amplification is used.

The measuring set with which these comparisons were carried out is shown in the heading illustration; the voltmeter is placed under the loop. Although this apparatus is very sensitive, it is not sufficiently so to allow measurements of the potentials induced in the circuit of the loop by distant transmitting stations. In order to measure these potentials, we placed before the vacuum-tube voltmeter the aperiodic (resistance-coupled) amplifier, which was preceded in turn by a radio-frequency amplifier. With this measuring set we were able to measure input radio-frequency potentials of 1/10,000 of a volt, which gives us the actual potential induced in the aerial by distant stations. The loop used with this apparatus is the same one shown as A in Fig. A.

With this apparatus there was measured late in the evening in the laboratory of the author in Berlin, the aerial voltage caused by reception from the one-kilowatt broadcast station in Madrid, Spain, at a distance of 1,175 miles; the potential which the 19-inch loop gave was in the order of one one-

(Continued on page 772)

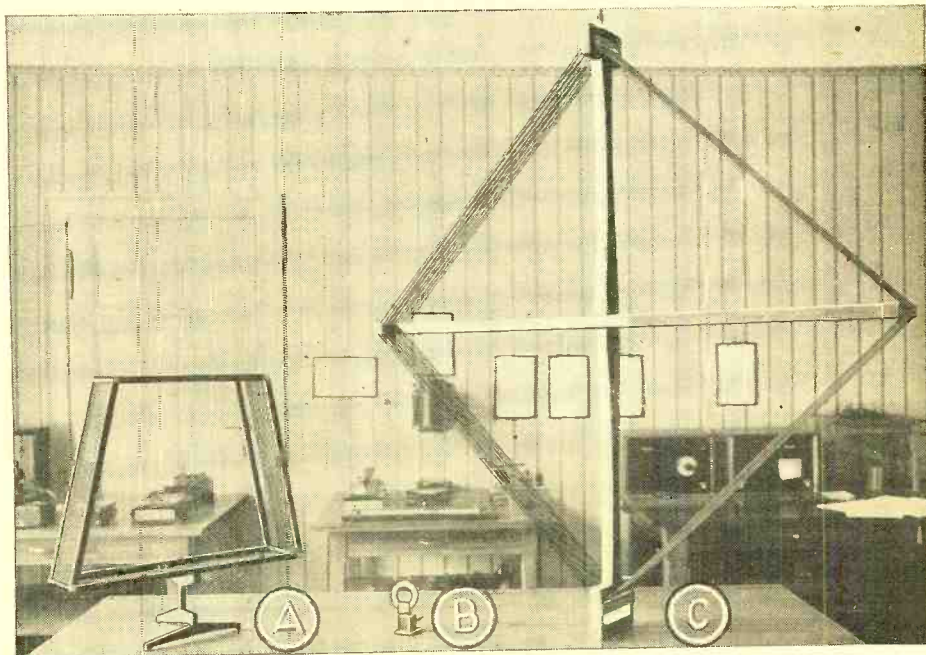
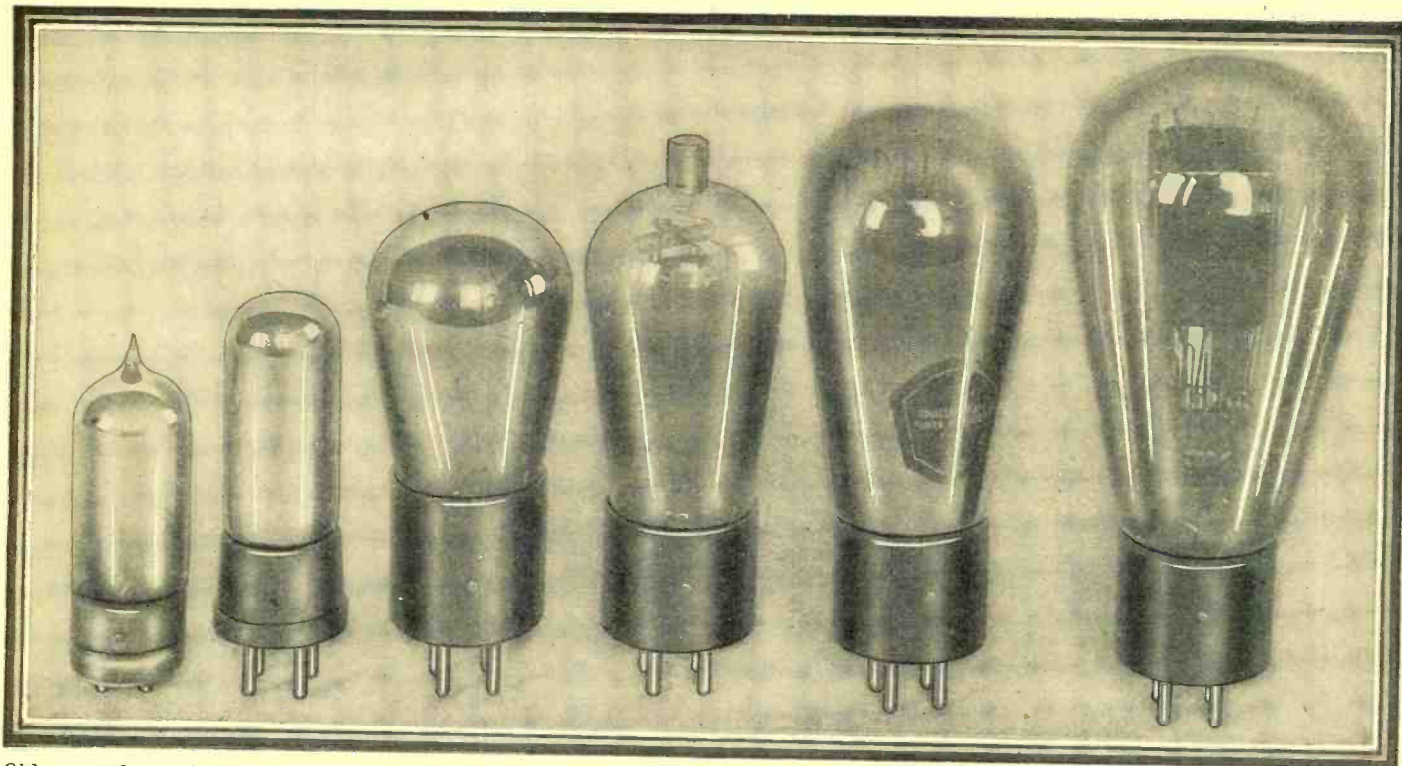

Fig. A

Of the loops of equal inductance, and tuned by condensers of the same size, the larger one gives by far the strongest signal. But, while a one-turn loop might be efficient, it is not a parlor ornament; at least in these days of small apartments.



Older members of the radio vacuum-tube family and their big younger brothers: the types are, from left to right, UV-199, UX-199, UX-201A, UX-222 (with control-grid cap), UX-210 and, last, but surely not least, UX-250, the giant of receiving tubes.

Radio Tubes and Their Characteristics

By H. M. Bayer

NEW TUBES GALORE

BACK in the forgotten years that we date B.B. (Before Broadcasting) when a radio tube was merely that and nothing more, the purchase of this important device comprised numerous steps, or stages, which eventually led up to the actual transaction. Mr. Experimenter, after many months of more or less satisfactory crystal reception, decided to obtain a vacuum-tube detector; the very thought of possessing this awesome instrument so thrilled him that he started saving for it at once. (Incidentally, radio apparatus, in those days, was not merely purchased; it was "saved for.") Through weeks of absence from the movies, and by the simple expedient of staying home on Wednesday nights, the ransom necessary to extricate the treasure from the clutches of the radio dealer was finally amassed. Then, on the long-awaited day, the prospective tube owner entrained for the city with imaginary bands seeing him off and spring very much in the air. His feelings as he got off the train and entered the store may readily be imagined; but the conversation which took place between him and the dealer is worthy of note. This conversation, it might be added, invariably followed fixed lines.

"Give me a tube," said the buyer, after he had been asked his wants. Doubtless, he was nervous and there was a touch of excitement in his voice.

"Right," was the terse reply of the dealer, as he reached back for the mysterious box, tested the contents, then wrapped it up and handed the precious burden to the thrilled radio fan.

And that was that! How times—and tubes—have changed!

* * * * *

At the present time the customer may make his selection from nearly forty types, the most commonly-used of which are produced in similar design under more than one trademark and type-number. The "general-purpose" tubes—that is to say, those which may be used both to amplify either R.F. or A.F. frequencies and as detectors—were until recently the only ones with which the set builder was familiar; even today tubes designed solely for the purpose of detection are comparatively little used. The increasing demand for volume and quality of amplification, however, compels the use of "power tubes"; which are adapted for use solely in the final stages of an audio amplifier where very high voltages and currents must be handled.

The introduction, however, of circuits in which "raw" or unrectified alternating current is used, to heat the filaments of tubes, has doubled the number of tube types on the market. There were about a dozen "storage-battery" types with filaments designed to be operated from direct current only, in addition to the power tubes; which, by reason of their final-stage position, may be lighted by alternating current, when desired, without introducing undue hum. There are now over a dozen different types of A.C. tubes, which will be found listed in this article, with descriptions of their characteristics. The rectifier tubes swell the list with seven more types; and three tubes devoted to automatic regulation purposes have been produced to meet the condition of fluctuating line-voltage which made electric-set operation inconvenient in some localities.

Television has introduced two new families to the radio public; the television lamps

(neon-gas glow-lamps) and the photoelectric cells. The latter, however, had been known for some time to scientists and engineers, though television interest has stimulated the demand for them and is working toward the improvement and mass production of these, as well as the television lamps. The latter, particularly, will be in great demand as television broadcasts are more generally undertaken. There are other tubes, such as the "grid-glow-relay" type and the oscillograph, which are of scientific and industrial use; but, as they are not suited to the requirements of the radio builder, they will not be described here.

In the description below of the "vacuum" tubes (including a few of the "gas-filled" types) which are adapted to use in a radio receiving set or its power unit, the attempt has been made to present them in logical order, with a concise statement of the most important characteristics of each, its functions, its socket connections, its voltage and current requirements, its plate resistance (impedance), amplification factor, and (in the case of the power tubes) its maximum undistorted output. The reader will find it to his advantage to keep this article at hand for reference when undertaking experimental or new constructional work.

GENERAL-PURPOSE TUBES

Under this head, as stated above, may be included most of the tubes of older design and those used in receiving sets of earlier models. With the specified voltages applied to their elements, tubes of any of these types might be used in all stages of a receiver.

Among the earliest tubes to find favor are four types generally known as "dry-cell" tubes, because of the low voltage and

small current consumption of their filaments. The first two of these, the WD-11 and WX-12, are still in use, though seldom if ever specified in new construction. The table of their characteristics should be sufficient comment.

WD-11 and WX-12-Types

Use, detector-amplifier (not power amplifier);
Socket, WD-11, special; WX-12, UX-type;
Filament voltage 1.1; current 0.25 ampere;
Plate voltage 22½ to 45 as detector, 90 to 135 as amplifier; current 1.5 mla. at 45 volts, 2.5 mla. at 90, 3.5 mla. at 135;
Grid bias 4½ volts at 90 plate, 10½ at 135 plate;
A.C. plate resistance 15,500 ohms at 90 volts, 15,000 at 135;
Amplification factor 6.6.

The second pair of dry-cell tubes, the UV-199 and UX-199 types, have found more favor and are more widely used, especially to obtain compact light construction. The two differ only in their bases; the first being designed to fit a special miniature socket, and the second adapted to the UX socket which is now standard. Both tubes are electrically alike; they function equally well in all receiver sockets, up to the limit of their current-carrying capacity; they have a companion, the UX-120-type, which is a true power tube, suited for the operation of a loud speaker. These tubes require three dry cells or a 4-volt storage battery for lighting their filaments (a 6-volt battery may be used with a suitable resistor) and draw but little current; as their filaments need be heated but moderately to give a heavy *electronic emission* and maintain a suitable path for the plate current.

X-199 and V-99-Types

Use, detector-amplifier (not power amplifier);
Socket, V-199, miniature; X-199, UX-type;
Filament voltage 3.3; current .063-ampere;
Plate voltage 45 as detector, 90 as amplifier; current 1.5 mla. as detector, 2.5 mla. as amplifier;
Grid bias, 4½ volts as amplifier;
A.C. plate resistor 15,500 ohms;
Amplification factor 6.6.

The 120-type, the earliest power tube, is a companion of the 199-type but is designed only for the last stage of audio amplification in a battery-operated receiver. It may be operated from either three dry cells wired in series or (provided a suitable resistor is in the filament circuit) a storage battery. A large grid-biasing voltage is absolutely necessary with this tube—22½ with 135 volts plate.

120-Type

Use, power amplifier (last A.F. stage);
Socket, UX-type;
Filament volts 3.3; current 0.132-ampere;
Plate volts 135; current 6.5 mla.;
Grid bias, 22½ volts;
A.C. plate resistance 6,600 ohms;
Amplification factor 3; undistorted output 110 milliwatts.

"STORAGE-BATTERY" TUBES

The 201A-type tube has been the favorite for all purposes for some years; it is the standard, all-around, flexible "storage-battery" tube of radio, functioning with high efficiency in radio-frequency, detector and audio-frequency circuits. More tubes of this design, undoubtedly, have been made than all others combined. Though it can be used as a last-stage audio amplifier, with 135 volts on the plate and the proper grid bias, the 201A is not a power tube; its maximum undistorted output is but 55 milliwatts. It is listed, also, under manufacturers' type numbers, as "301A" and "AX." (Type numbers of other manufacturers were not obtainable at time of writing.)

201A and 201B-Types

Use, detector-amplifier (not power amplifier);
Socket, UX-type;
Filament voltage 5; current 0.25-ampere for 201A, 0.125-ampere for 201B;
Plate voltage 45 as detector, 90 to 135 as amplifier; current 1.5 mla. as detector, 2.5 mla. at 90 volts, 3.0 mla. at 135 volts, as amplifier;
Grid bias 4½ volts at 90 plate, 9 at 135;
A.C. plate resistance 11,000 ohms at 90 volts, 10,000 at 135;
Amplification factor 8; undistorted output 15 milliwatts at 90 volts, 55 at 135.

The 01B-type tube is identical with the 201A-type; except that its filament at 5 volts draws 125 milliamperes (one-eighth ampere) instead of the customary quarter-ampere of the 201A-type. It was designed to answer the demand for a tube which may be used in series operation with rectified A.C. on the filaments. Because of the slight current drain of the 01B-type filament, it is possible to obtain from a rectifier of the 280 or 281 type sufficient current for a receiver using these tubes, provided they are wired in *series*. It is very essential that the proper grid bias be used with this tube whenever the plate voltage exceeds 40.

The characteristics of the K-type tube show it to be well adapted for radio-frequency amplification with the usual R.F. transformers employed today in T.R.F. sets. The use of this tube is recommended only in sets having adequate provision for re-adjustment of neutralization. Its plate resistance is almost twice that of the 201A type; its electrical characteristics differ from the latter principally in this matter.

POWER TUBES

The 112-type tube, though engineered before the development of the A.C. receiver for storage-battery operation, may also be used with alternating current; though, as with all other tubes of D.C.-filament design, only when used as a power amplifier. This tube, however, though not classified by manufacturers as a general-purpose tube, functions with remarkable efficiency in any socket of the receiver. The present type, 112A, has a filament consumption reduced to a quarter-ampere at 5 volts; this type is manufactured, also, as F-12-A.

The 171A tube, perhaps, is the most popular power amplifier at the present time. It has an extremely low output impedance

and is suitable for use in the last stage only. Since the plate current of this tube is exceptionally high at maximum voltage, some form of loud-speaker coupling, such as an output transformer or a choke coil and a by-pass condenser, should be used to prevent the heavy direct-current component from passing through the windings of the loud speaker. Alternating current may be applied directly to the filament of the 171A, only when it is used in the last audio stage. It replaces the old 171-type, which drew half an ampere of filament current.

112A-Type

Use, amplifier, power amplifier or detector;
Socket, UX-type;
Filament voltage 5; current 0.25-ampere;
Plate voltage 90 as amplifier, 135 to 180 as power amplifier, 45 as detector; current 5.5 mla. at 90 volts, as amplifier, 7 mla. at 135 volts, 10 mla. at 180 volts as power amplifier, 1.5 mla. as detector;
Grid bias 4½ volts at 90 plate, 9 at 135; 13½ at 180;
A.C. plate resistance 5,300 ohms at 90 volts, 5,000 at 135, 4,700 at 180;
Amplification factor 8; undistorted output 120 milliwatts at 135 volts, 300 milliwatts at 180.

171A-Type

Use, power amplifier (last stage only);
Socket, UX-type;
Filament voltage 5; current 0.25-ampere (may be A.C.);
Plate voltage 135 to 180; current 16 mla. at 135 volts, 20 mla. at 180;
Grid bias 27 volts at 135 plate, 40½ at 180 (Note: When a power tube has A.C. filament supply, it is necessary to increase the grid bias by one-half the filament voltage, or 2½ volts, here);
A.C. plate resistance 2,200 ohms at 135 volts, 2,000 ohms at 180;
Amplification factor 3; undistorted output 330 milliwatts at 135 volts, 700 milliwatts at 180.

LARGER POWER TUBES

The 210-type especially, because of its heavy filament-current requirement, is usually operated with alternating current from a special transformer secondary, direct to its filament, and is used in the last audio stage only. It is capable of handling far greater volume without distortion than any other receiving tube except the recently introduced 250-type. The high plate current of this tube makes a loud-speaker coupling device, such as those recommended for use with the 171A-type, a necessity. The filament of this tube is normally operated from the 7.5-volt winding of a step-down transformer, and draws 1¼ amperes.

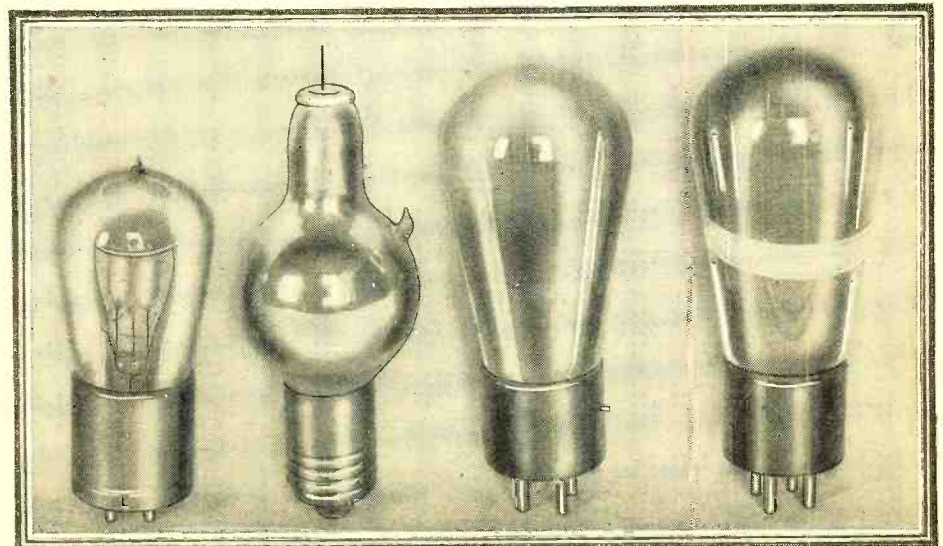

Well-known rectifying tubes; left to right, gas-filled filamentless, gas-filled filament, half-wave (one-plate), and full-wave (two-plate) filament types.

The 250-type is the largest and most powerful power amplifier manufactured for radio reception, and capable of handling more than three times as much undistorted energy as the 210-type. Obviously, while the new tube is capable of enormous output, it should be employed at but a fraction of its full capacity, thus securing undistorted output at all times with ample reserve power. The output of this tube must lead into a protective coupling device.

210-Type

Use, power amplifier only;
Socket, UX-type;
Filament voltage 7.5; current 1.25 amperes (usually A.C. from special winding);
Plate voltage 250 to 425; current 12 mla. at 250 volts, 16 mla. at 350; 20 mla. at 425;
Grid bias 18 volts at 250 plate, 27 at 350, 35 at 425;
A.C. plate resistance 5,600 ohms at 250 volts, 5,000 at 425;
Amplification factor 8; undistorted output 340 milliwatts at 250 volts, 925 at 350 volts, 1,540 at 425 volts.

250-Type

Use, power amplifier only;
Socket, UX-type;
Filament voltage 7.5; current 1.25 amperes (usually A.C. from special winding);
Plate voltage 250 to 450; current 28 mla. at 250 volts, 35 at 300, 45 at 350, 55 at 400, or 450;
Grid bias 45 volts at 250 plate, 54 at 300, 63 at 350, 70 at 400, 84 at 450;
A.C. plate resistance 2,100 ohms at 250 volts, 2,000 at 300; 1,900 at 350; 1,800 at 500 and 450;
Amplification factor 3.8; undistorted output 900 milliwatts at 250 volts; 1,500 at 300; 2,350 at 350; 3,250 at 400; 4,650 at 450.

"HIGH-MU" AND SPECIAL-DETECTOR TUBES

The "high-mu" 240-type tubes (classified, also, as types "340," and "G") were designed especially for use with resistance- or impedance-coupled audio amplifiers. It is important that the plate voltages, on the 240-340-types, be applied through a plate-coupling resistor of 250,000 ohms; and coupling resistors of 50,000 to 75,000 ohms and a plate voltage of 135 should be used with the "G" type.

240-Type ("High-Mu")

Use, resistance- or impedance-coupled amplifier or detector;
Socket, UX-type;
Filament voltage 5; current 0.25-ampere;
Plate voltage 135 to 180, as amplifier or detector; current 0.2-mla. as amplifier, 0.3- to 0.4-mla. as detector;
Grid bias 3 volts at 135 plate, 4½ at 180. With 250,000-ohm plate resistor, bias 1.5 volts at 135 plate, 3 at 180.
A.C. plate resistance 150,000 ohms;
Amplification factor, 30.

The "special-detector" 200A-type tube is designed for this purpose only and is available, also, under the designations of type 300A, and type H. It is not at all critical to voltage adjustments, and may be substituted for a 201A-type in the detector socket *without circuit or voltage changes.* (Except that type H requires a minimum plate voltage of 67.) The use in this stage of a specially-designed tube of this type, it is claimed, produces additional sensitivity and volume nearly equal to that which would be obtained by the addition of one stage of radio-frequency amplification; it is particularly helpful when receiving distant stations. The tube's mechanical and electrical characteristics are identical with those of the 201A-type, except that its A.C. plate resistance is 30,000 ohms, and its amplification factor 20.

200A-Type

Use, special detector;
Socket, UX-type;
Filament voltage 5; current 0.25-ampere;
Plate voltage 45; current 1.5 mla.
A.C. plate resistance, 30,000 ohms;
Amplification factor, 20.

SCREEN-GRID TUBES

The 222-type is a four-electrode screen-grid tube, designed particularly for radio-frequency amplification, but adaptable as a "space-charge" tube to A.F. amplification. With proper shielding of the radio-frequency circuit, neutralizing and stabilizing devices are unnecessary because of the extremely small capacity between control-grid and plate. The shielding "screen-grid" between

the usual third-element (or "control-grid") and the plate thus eliminates the effect of plate-to-grid feed-back capacity; and it also increases the "mutual conductance"; that is, the current output-signal input ratio of the tube. Special coupling circuits are therefore required. The filament of this tube operates at 3.3 volts and draws 0.132 amperes; but, with a series resistor of 15 ohms, it may be connected in parallel with the 5-volt filaments of other tubes.

222-Type (Screen-Grid)

Use, amplifier (not power amplifier);
Socket, UX-type (control-grid terminal at top of tube);
Filament voltage 3.3; current 0.132-ampere;
Plate voltage 135 as R.F. amplifier; current 1.5 mla. with 1½ volts on control-grid, 1 mla. with 3 volts. (See below.)
Plate voltage 180 as A.F. amplifier, "space-charge" connection; current 0.3-mla. with 1½ volts on screen-grid.
Special voltage 45 on screen-grid as R.F. amplifier; 22½ on inner ("control") grid with "space-charge" connection as A.F. amplifier.
A.C. plate resistance with 135 volts, 850,000 to 1,100,000 ohms, depending on grid voltage; with 180 volts, "space-charge" hook-up, 150,000 ohms;
Amplification factor as R.F. amplifier 300 (theoretical; reduced by circuit limitations); as space-charge A.F. amplifier 60.

ALTERNATING-CURRENT TUBES

The filament of the 226-type tube is operated on raw alternating current; so that it cannot be used in place of the 201A-type unless suitable circuit changes are made. Though this tube is fitted for use as an R.F. or A.F. amplifier, with an amplification factor equal to the 201A-type, *it cannot be used as a detector* because of the hum which it would introduce; and, as an amplifier, it must be used with a grid bias. Though its filament is rated at 1.5 volts, the recommended voltage is 1.35; to avert the rapid deterioration of the oxide coating of the filament, which sets in when excessive voltage is applied. As an audio amplifier the 226-type is capable of an undistorted output of 160 milliwatts at 180 volts, and of 70 at 135 volts, compared with 55 for the 201A. Other type numbers are 326 and M-26.

226-Type (A.C. Direct-to-Filament)

Use, R.F. or A.F. amplifier (not detector);
Socket, UX-type;
Filament voltage 1.5 "raw" (unrectified) A.C.; current 1.05 amperes;
Plate voltage 90 to 180; current 3.5 mla. at 90 volts, 6 at 135, 7.5 at 135.
Grid bias 6 volts at 90 plate, 9 at 135, 13½ at 180;
A.C. plate resistance 9,400 ohms at 90 volts, 7,400 at 135, 7,000 at 180;
Amplification factor 8.2; undistorted output 160 milliwatts at 180 volts.

The 227-type is of the "indirectly-heated-cathode" type. That is to say, although raw alternating current is applied to the "heater" (a tungsten filament which passes through the center of the "cathode," from which it is insulated), the function of this current is merely to heat the cathode. The latter element takes upon it the duty of the filament in a D.C. tube as the actual electron-emitter and furnishes the neutral point on which both plate voltage and grid bias are based. The 227 was designed for use as a detector employing a grid leak and condenser, and requires no bias when so used; but it may also be used as either a radio- or an audio-frequency amplifier with considerable similarity, in characteristics, to the 201A-type. It has been found that the use of 227-type tubes in a set throughout, except in the last audio stage,

(Continued on page 777)

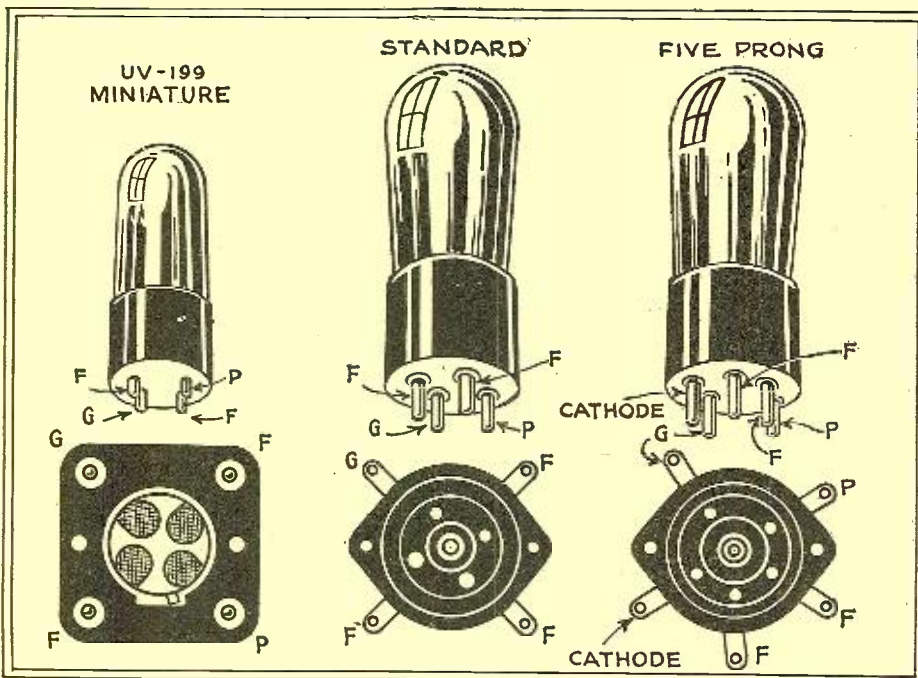

The UV base and socket (left) are now little used; the UX (center) is practically universal but for certain A.C. tubes which require the UY (right).



No. 73



A set of blueprints, showing the details of all the shields and including a list of the parts used in the original construction of the "Copperclad Special," will be sent free of charge to any reader who intends to construct this receiver. Use the coupon on page 770 of this number; no blueprints will be sent free without this coupon, which is provided for our mutual convenience.

A LARGE number of radio experimenters who have made the famous "Junk-Box" set and other simple short-wave receivers of the straight regenerative type have written for directions on adding a stage of tuned radio-frequency amplification. Many of these people have had experience with R.F. sets designed for the regular broadcast band and appreciate the manifold advantages of R.F. amplification. Comparatively few, however, realize that R.F. amplification on the short waves (that is, below 100 meters) is very much more difficult to handle than it is on the broadcast wavelengths between 200 and 550 meters. An unshielded R.F. "booster unit" can be thrown ahead of a regenerative broadcast receiver and will work smoothly the instant it is turned on; but a similar R.F. unit placed before a short-wave tuner is likely to ruin the "works."

For those constructors and short-wave enthusiasts who want to enjoy the benefits of R.F. amplification when they are fishing for England, Russia, the distant island of Java or continent of Australia, the writer has designed a complete receiver with the radio-frequency amplifier built in, as an integral part of the assembly. A permanent arrangement of this kind is far more satisfactory than a makeshift one, in which the R.F. unit has been added merely as an afterthought; while it is no more expensive

or difficult to construct. Because of the distinctive appearance given the instrument by its complete shielding of copper, it has been appropriately named the "Copperclad Special."

As far as the amateur experimenter is concerned, the Copperclad Special might easily be described as the last word in short-wave receivers. It uses one stage of tuned R.F. amplification, with a screen-grid (222-type) tube as the R.F. amplifier, followed by a regenerative detector; the antenna coupler and its associated tuning condenser are completely enclosed in one copper shielding can, the screen-grid tube, in another and smaller compartment; and the components of the detector circuit are cased in still a third shield.

NO HAND CAPACITY

There are three controls, all variable condensers, but they do not require three hands. The regeneration condenser (the center one) may be left in one position while the tuning condensers are turned through a movement of about 20 degrees on the dial before a readjustment on it is necessary. The re-

SHORT-WAVE FANS!

THE "Copperclad Special" is the best short-wave receiver RADIO NEWS has yet described; it uses a "tuned" stage of screen-grid radio-frequency amplification, and is completely shielded by copper cans, that you yourself can make without great trouble. There are no "dead spots" in its tuning range, and neither are there hand-capacity effects of any kind. The detector slides in and out of oscillation with beautiful smoothness, and allows you to fish out those weak stations that you know are somewhere in Europe or in the Antipodes. Build this set if you want to experience a real "kick."

generative action is smooth and clean over the entire tuning range of each set of plug-in coils; there are none of the "dead spots" that are so annoying in straight regenerative outfits. Furthermore, there are also-

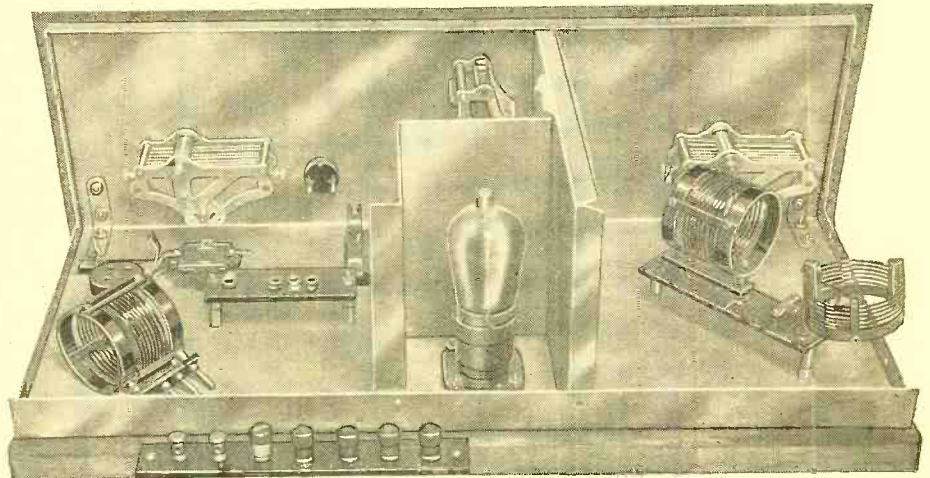

Fig. A

The "Copperclad Special" without its top and back; it is half completed, and not yet ready for wiring. The back flange must be drilled to pass "B" leads.

* RADIO NEWS Free Blueprint Article No. 73. (See page 770.)

lutely no hand-capacity effects of any kind. The operator can tune in a station, remove his hands from the dials, and the signals will remain absolutely unchanged. He can put his hands anywhere on the outfit, without affecting the tuning in the slightest degree. Only those listeners who have developed "wooden" arms and stiff necks, while trying to hold on to a weak short-wave station with an unshielded set, can appreciate this gratifying feature.

In sensitivity the Copperclad Special is superior to any short-wave receiver the writer has ever played with. He has no way of measuring the actual amplification afforded by the tuned screen-grid stage; but, as might be expected, it is decidedly greater than that given by the untuned screen-grid hook-ups now used in many popular sets. Of course the price of this increased sensitivity is a third control on the panel, besides the initial labor of cutting up a couple of square yards of sheet copper, but the extra dial really produces no tuning complications, and the tinsmithing on the shields takes only an evening.

As the receiver now stands, it does not include an audio amplifier; but most experimenters have an old transformer-coupled amplifier lying around or, at least, they can assemble a single stage in about five minutes. The two tubes give about as much "kick" as a good straight-regenerative short-wave with one stage of audio; so the constructor may connect his phones directly to the output posts and enjoy excellent results without any additional A.F. amplification. If he wants to become the hero of the neighborhood by putting 5SW (England) or PCJJ (Holland) on the loud speaker, he can hook in to the regular amplifier he uses with his broadcast receiver.

PARTS REQUIRED

The tuning range of the Copperclad Special is 16 to 90 meters with three pairs of factory-made plug-in coils; this can be raised to 200 meters by the use of additional coils made by the same manufacturer. The complete dimensions of the coils used in the original model are shown in an accompanying drawing (Fig. 3) for the benefit of those experimenters who like to make their own coils; but the writer recommends that the inductors be purchased, complete with their convenient mounting-receptacles. They are very cheap, they save a great deal of trouble, and they assure satisfactory results.

A complete list of the parts necessary for the Copperclad Special follows. The experienced constructor may safely use his

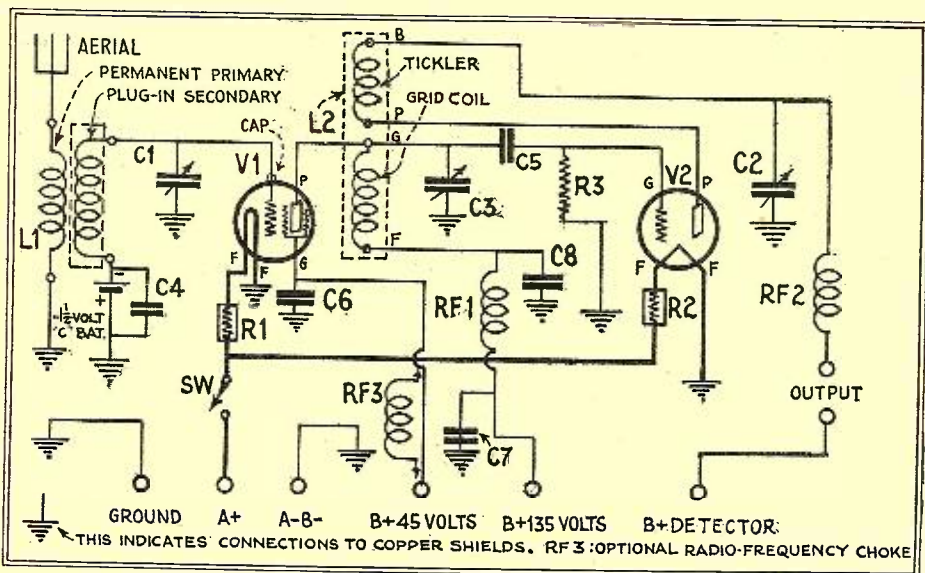

Fig. 1

Nothing unusual in the circuit; but to make a tuned R.F. stage work on short waves requires careful construction. The complete shielding saves wiring.

own discretion in choosing suitable makes; but readers who wish to duplicate the original model will find a list, with the manufacturers' names, included with the free blueprints.

Two variable condensers, .00014-mf. (.00015-mf., or .00016-mf.) capacity, C1, C3;

One variable condenser, .00035-mf., C2;

Five fixed condensers; two .006-mf. or anything larger, C4 and C8; one .0001-mf. grid condenser, C5; two 1/4-mf. by-pass condensers, C6, C7;

Three sets of plug-in coils, to cover wavebands 16-90 meters, with mounting receptacles, L1, L2;

Two amperites, one 222-type, R1; one 201A type, R2;

One grid leak, five megohms, R3;

Two R.F. choke coils, 85- or 90-millihenry, RF1, RF2 (a third, RF3, is optional);

Two UX-type tube sockets.

Two vacuum tubes: one 222-type, V1; one 200A-type, V2;

One filament switch, SW;

Three vernier dials, to fit the selected condensers C1, C2, C3;

One 1 1/2-volt "C" battery, consisting of a single flashlight cell;

One front panel, 7 x 21 x 3/16 inches;

One wooden baseboard 9 1/2 x 20 x 3/4 inches;

Nine binding posts: one binding-post strip, 1 x 7 x 3/16 inches, to accommodate 7 posts;

Four small brass hinges, 1 inch wide;

Six pieces of soft sheet copper, five of them about 1/32-inch thick: piece A (panel cover), 21 by 7 1/2 inches; piece B (baseboard cover) 21 by 9 1/2 inches; piece C (stage partition) 10 by 7 inches; piece D (tube shield), 8 by 6 1/2 inches; and piece E (back and sides) 38 x 6 1/2 inches.

One piece F (top of can) 20 1/2 by 8 3/4 inches, should be cut from heavier metal, about 1/16-inch thick.

SHIELDING CONSTRUCTION

The first thing to do is to drill the front panel for the three condensers C1, C2, C3, and for the filament switch SW; a full-size template which will be very useful for this purpose is supplied with the free blueprints. Test the fit of the condensers and vernier dials and of the switch, and remove them from the panel. Now drill five holes along the bottom of the panel and fasten it against the edge of the wooden baseboard. The latter is 20 inches long, and the panel is 21; center it so that the panel hangs over a half inch on each side. Use flat- or oval-head wood-screws about one inch long.

The main work of the set, that of cutting and bending the copper sheets, now begins. When buying the copper, have the various pieces cut exactly to the dimensions shown in the blueprints, with the edges nice and square. All metal supply houses have large shears which the salesman will use for the purpose. With the edges square, you will be able to mark out the guide lines easily.

Start with piece A, the panel cover. Mark off a half-inch border along the top and two sides, and a one-inch border along the bottom, as in Fig. 6. With a pair of tinner's snips (you can buy a good pair for less than a dollar) cut out the shaded sections, and bend in the edges toward you. The best way to do the bending is with a piece of lumber and a hammer. Your local carpenter or builders' supply dealer will give you a six- or ten-inch length of "2-by-4" for the asking. Lay the copper sheet flat on a strong table, and place the edge of the 2-by-4 along the marked line on the sheet. Lean heavily on the wood, and with a screwdriver, pick up the edge of the copper; when it is about a quarter of an inch up, push it against the wood with the hammer. Push the wood slightly toward the

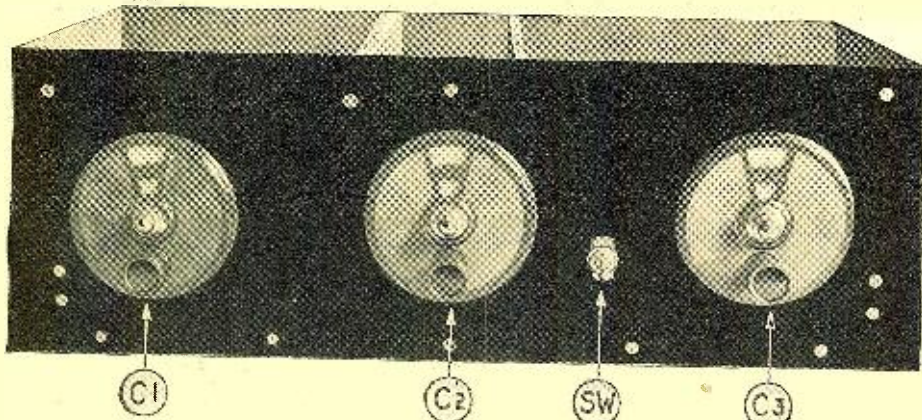

Fig. B

"The Copperclad Special" with top removed; only two dials are used at once.

hammer, to compensate for the pushing effect of the latter. You will find that the soft copper bends with surprising ease, and can be worked without trouble.

With its four edges turned in nicely, at right angles, place piece A flat against the back of the panel, and push its bottom corner snugly against the junction of the panel and the wooden baseboard. If it does not lie smoothly against the panel, straighten out the little bumps by pressing gently against them with your fingers.

Now cut and bend piece B, which is the baseboard cover; note carefully that the back flap on this piece is one inch high, while the two sides are only half an inch high, and also that the front edge is left flat (See Fig. 7). This flat edge is pushed beneath the protruding one-inch edge of the panel cover to form an overlap.

the baseboard (looking at the set from the rear). Where it butts against piece A near the top of the panel, fasten it down with a machine-screw passing through the panel. Drill four holes through the bottom lip of C, and four corresponding holes through the baseboard cover B, and fasten the lip down with round-head wood-screws; do not tighten these screws at first, as you will want to remove the partition for the drilling of other holes.

The tube shield, piece D, is an L-shaped corner, which forms two sides of what finally will be a square box for the screen-grid tube (Fig. 9; see also Fig. 4). The stage partition C is the third side and the back of the shielding can will be the fourth; this back is the middle of one long strip of copper E, which forms also the two sides of the cabinet. After cutting this

In order to hold the piece E in place, drill corresponding holes through it and through the bent-up flanges or lips of pieces A and B, and also through the back flanges of the stage partition C and the tube shield D. When you fasten the "whole works" together with short 6-32 machine-screws, you will find it to be very strong and rigid. If the constructor prefers, of course, aluminum or brass may be used for shielding material, with equal advantage electrically.

The last thing, of course, is the top of the cabinet. This is the plain flat sheet F, 20½ inches long and 8¾ inches wide. After it is hinged to the top edge of piece E, it will overhang a quarter of an inch on each side, and will fall short of reaching the panel by another quarter of an inch. It will form a complete cover, however, because there is a half-inch lip of A on which it rests.

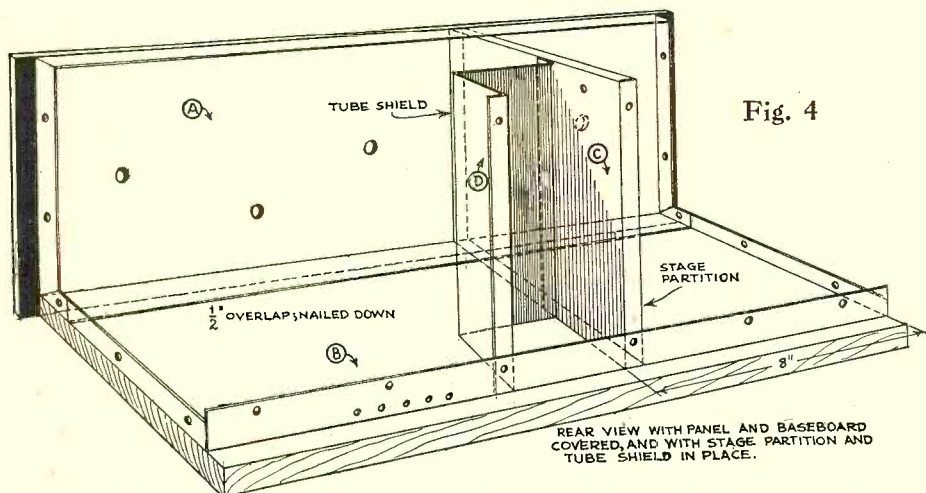

Fig. 4

The method of assembling the earlier shielding; after the wiring has been completed, the back E (which is also the sides) and top F are easily added.

MATCHING THE PIECES

Place the panel cover A back in position and hold it in place temporarily with two small clamps, such as the "5 & 10" stores sell. With a thin nail, trace the outlines of the condenser and switch holes from the front side, and then drill out holes of the same size in the copper. Mount the condensers and switch against the copper and tighten down the fastening nuts. Make certain that the frames of the condensers make good contact with the copper, as they are grounded automatically through the latter.

To hold the top of piece A flush against the panel, drill holes through the copper and the panel in the uppermost corners, and tighten down the shields with a couple of machine-screws and nuts. A third screw above the center condenser will also help.

Slide the baseboard cover, piece B, against the one-inch edge of piece A, so that the front edge of B fits under the latter, as mentioned above; the baseboard will now be covered by a shallow pan 20 inches long and 9 inches wide. Drive half a dozen small nails through the overlap joint right into the wood, and similarly nail down the corners and edges. To give the assembly additional strength, the writer mounted two L-shaped brass brackets to the panel and baseboard, just beneath one condenser C1 and at the side of the other, C3.

The stage partition, piece C, is a simple shallow pan 6 inches high, 9 long, and ½-inch deep as shown in Fig. 8. Place this partition 8 inches from the right edge of

piece E according to the layout (given with the free blueprints, but not published with this article) you will notice that the bottom edge of the back is half an inch above the baseboard, but still makes an overlap with the upright one-inch edge of piece B; the purpose of this arrangement is to allow you to drill four holes through the latter, just to the left of the tube shield. Thus you can bring the battery wires through these holes to the binding posts, and wire the set completely before assembling the back and top of the copper cabinet.

WIRING IS SIMPLE

The rest of the assembly is very simple. Take one of the receptacle bases for the plug-in coils and mount it diagonally at the right of the stage partition, as shown at L1, Fig. 2. This base is fitted with a hinged primary coil; place it so that the primary folds back into the extreme lower-right corner of the compartment. Drill two holes through the baseboard and the copper, and use two long machine-screws for the actual mounting. Raise the receptacle about an inch above the surface of the baseboard cover B by means of a stack of washers, or any available metal collars.

The "C" battery and its by-pass condenser C4 need not be fastened in any particular manner. Simply solder wires to them and let them lie in the corner, against the stage partition.

The locations of the various components of the detector circuit are made clear in the various accompanying illustrations (Figs. A and C and the layout wiring diagram, Fig. 2). Before mounting the other receptacle for the plug-in coils, remove the primary coil altogether, as it is not used. The procedure in mounting a part is this: first determine the proper position for it, and spot the screw holes on the copper with a thin nail or a pencil. Drill through the copper, but do not let the drill go deeply into the wood beneath. Then you can turn in the wood-screws.

The grid condenser C5 is supported above

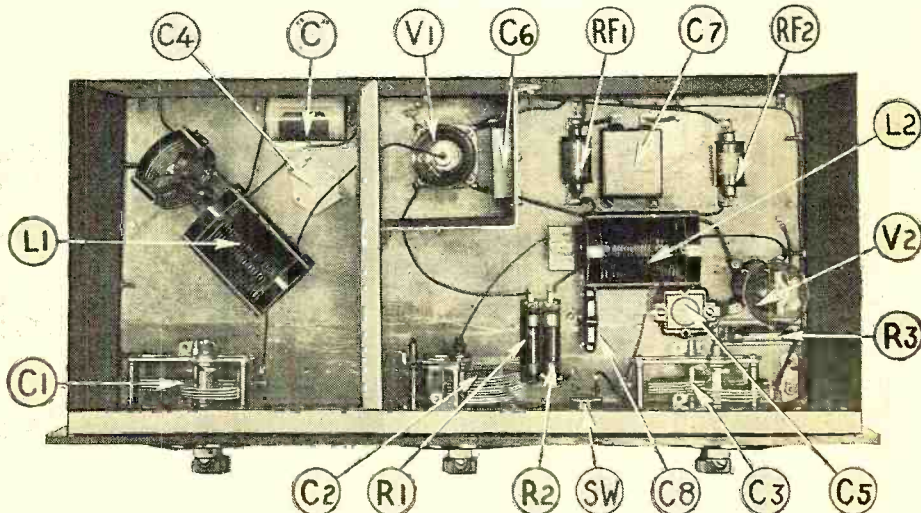

Fig. C

The placement of parts in the "Copperclad Special" and all the wiring is visible from above. The coils have plenty of room and the set is well by-passed.

the baseboard by a short brass bracket which is screwed directly under the grid binding post of the socket V2. The blocking condenser C8, however, is mounted to the baseboard, as one side of it must be grounded, anyway.

Before screwing the tube shield D in place, drill three holes along its bottom for the filament, plate and grid wires; and also mount one of the by-pass condensers, C6, to the inside of the shield. Solder a wire from one lug of the condenser directly to the copper, and leave a four-inch length soldered to the other lug for connection to the "G" post of the socket V1 of the screen-grid tube. Solder ten-inch pieces of wire to the "F plus," "G" and "P" posts, pull them through the holes, and then screw down the shield.

The wiring is very simple, as half the connections are made to the copper shields, which form the negative side of the filament circuit as well as the ground. Note carefully that a flexible wire runs from the "G" post of the coil L1 through the stage partition C to a clip which goes over the cap of the screen-grid tube in V1. Make this wire as short as possible.

The aerial binding post is mounted on a little strip of bakelite, screwed to the wood of the baseboard directly behind the mounting for L1. The battery binding posts are on a 7-inch strip fastened also to the edge of the baseboard, by a pair of L-shaped brackets. The "A-B—" post is connected by a short length of wire to the copper shielding; the other four wires run through holes which were, as previously mentioned, drilled low in the upright flange of the baseboard cover B. Make certain that the insulation of the wires is not worn; as otherwise the connections will be a dead short circuit against the grounded copper.

After soldering in all the wires, test them for short circuits against the copper by connecting a pair of phones in series with a

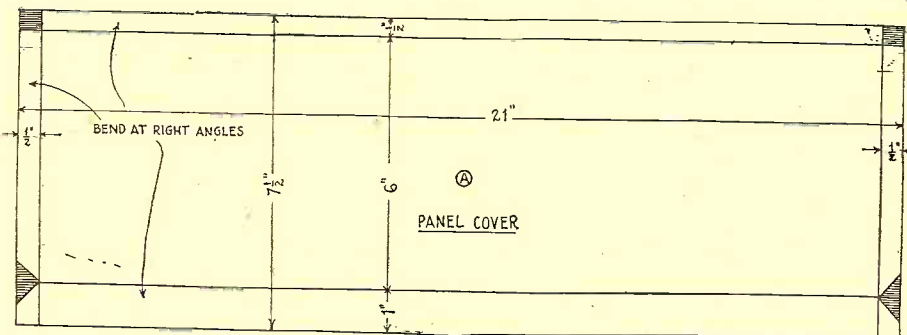

Fig. 6

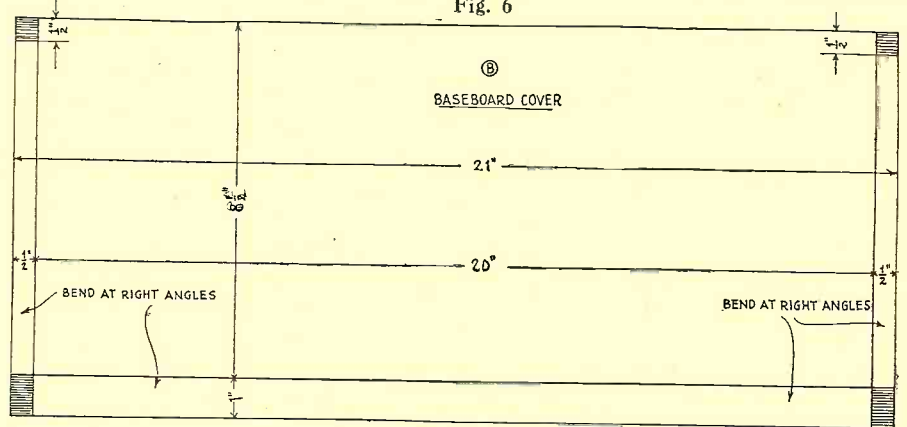

Fig. 7

The panel cover, after being cut and shaped, should be fitted to the drilled panel to spot the necessary holes, for greater exactness. The rear flange of the baseboard cover, also, must be drilled for leads.

"B" battery; one tip of the phones is held against the copper and the free end of the battery touched against the successive binding posts. The phones should remain silent when the free wire is touched to any of the posts except, of course, the "A—" and "A+." The R.F. chokes used in this set fit into grid-leak clips, and these should be tested particularly. The writer burned out one pair of chokes before he discovered that

the overhanging edges of the clip springs were touching the copper lightly.

After completing and testing the wiring, mount the back and top of the copper shielding cabinet permanently in place. You can then get to the tube sockets and coil mountings by merely raising the hinged top.

OPERATING CONDITIONS

The electrical action of the Copperclad Special is the same as that of any R.F.-regenerative detector arrangement. Signals picked up by the aerial are tuned in by the condenser C1 in conjunction with the plug-in secondary of L1, and are amplified by the screen-grid tube, V1. The amplified signal is transferred from the plate of the screen-grid tube to the grid circuit of the detector, V2; the detector circuit being tuned to the wavelength of the signal by the circuit consisting of condenser C3 and the grid coil of the plug-in unit L2. The regenerative action of the detector tube, caused by the presence of the tickler beyond what it is normally; or the tickler can throw the tuned circuit L2-C3 into oscillation, so that incoming signals are "heterodyned." This principle of short-wave operation has been fully explained in recent issues of RADIO NEWS.

With 135 volts on the plate of the screen-grid tube, V1, a grid bias of 1 1/2 volts is specified by the manufacturers; this is furnished by the "C" battery in the first-stage compartment. The condenser C4 acts simply as a low-resistance path around the battery for the weak radio-frequency current induced in the secondary by the primary coil. The condenser C6 serves to keep transient R.F. currents out of the battery circuit, by shunting them directly back to the filament. An additional choke coil, indicated in the schematic diagram as RF3,

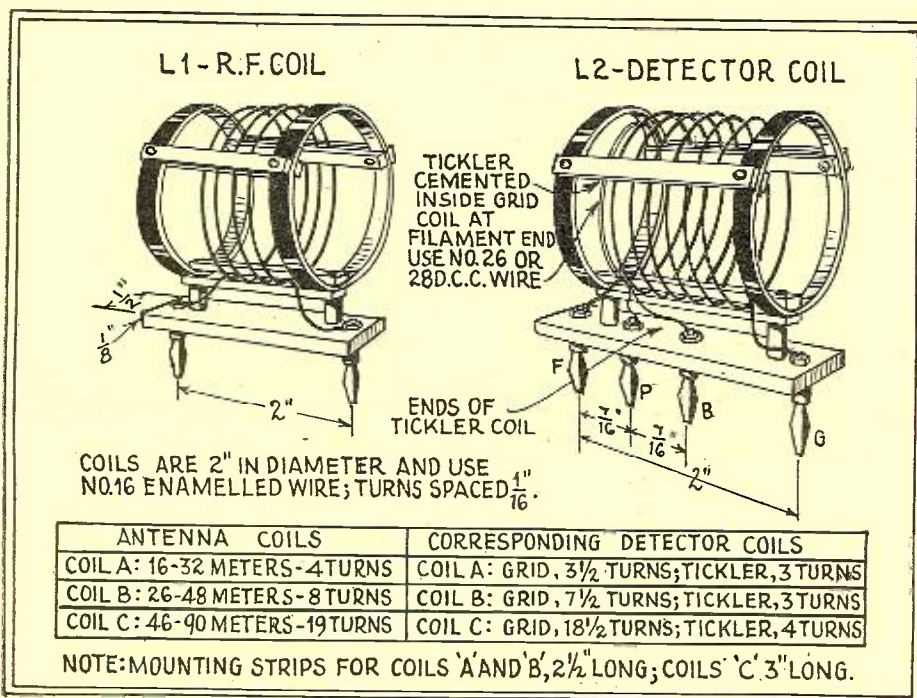

Fig. 3

The physical dimensions of the coils used are given above, but slight variations from the bands given are unavoidable with home-made coils. The hinged-base, separate primary of L1 is the same for all bands—5 turns of No. 16 wire, 2 inches in diameter.

ANTENNA COILS	CORRESPONDING DETECTOR COILS
COIL A: 16-32 METERS-4 TURNS	COIL A: GRID, 3 1/2 TURNS; TICKLER, 3 TURNS
COIL B: 26-48 METERS-8 TURNS	COIL B: GRID, 7 1/2 TURNS; TICKLER, 3 TURNS
COIL C: 46-90 METERS-19 TURNS	COIL C: GRID, 18 1/2 TURNS; TICKLER, 4 TURNS

NOTE: MOUNTING STRIPS FOR COILS 'A' AND 'B', 2 1/2" LONG; COILS 'C', 3" LONG.

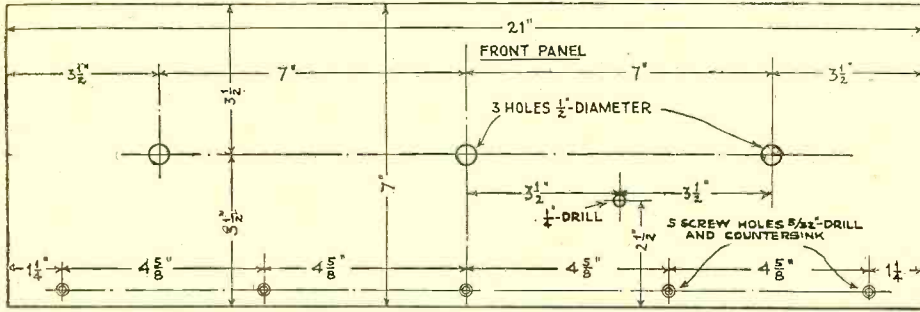

Fig. 5
Drilling details for the front panel of the "Copperclad Special."

and connected in series with the wire running to the screen-grid of tube V1, is also likely to be helpful, and should be tried.

The R.F. choke RF1 allows the direct current of the "B" battery to reach the plate of the screen-grid tube, while it prevents the R.F. output of the tube from losing itself in the battery circuit. The R.F. signal is forced by this choke to flow to the grid of V2, where it belongs. The grid condenser C5 lets the R.F. current through, but blocks the 135 volts of "B" battery. Condenser C8 performs a similar function, keeping the "B" battery out of the grid circuit but allowing the R.F. current to pass through.

Each of the plug-in coils used in this receiver consists of a grid or secondary coil of heavy wire, and a tickler of fine wire. Remove the ticklers entirely from one set of coils and also take out the plugs to which they were connected; these are unnecessary because the coils are used across the screen-grid tube, in a non-regenerative hook-up. From each of the secondaries of the other coils remove half a turn of wire; this is

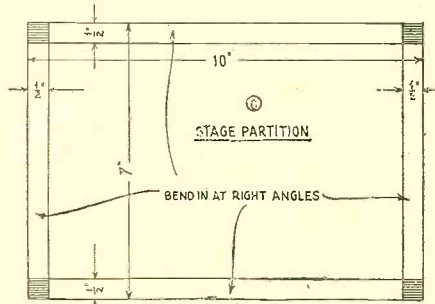

Fig. 8

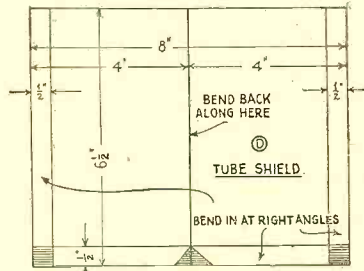

Fig. 9

necessary to make the dials of C1 and C3 read alike.

The R.F. amplifier tube, V1, is a screen-grid tube of the 222 type, and requires 135 volts on the plate and 45 volts on the screen-grid; the detector tube, V2, is a special detector of the 200A type, and works on 45 volts. A six-volt storage "A" battery and three 45-volt "B" battery blocks are therefore necessary for the proper operation of the set. To the posts marked "Output" may be connected either a pair of telephone receivers or the primary of the first audio transformer, if audio amplification is used.

TRICKS OF TUNING

The operation of the "Copperclad Special" is like that of any short-wave set. The past three issues, in particular, of RADIO NEWS, contained a great deal of matter dealing with the tricks of "zero beating" and the handling of the regeneration control—in this case the center condenser, C2. To start with, plug in the largest coils, set C. Station W8XK, the 62.5-meter short-wave transmitter of KDKA, lies in the band covered by these coils, and can be spotted on the dials very quickly. This station, whose transmitter is illustrated on pages 750-1, is one of the most reliable
(Continued on page 764)

In addition to the partition and shield shown at the left, two other pieces are needed, E and F, the former 6 1/2 x 38 inches, cut out at the back where the leads pass through the flange of B. F is of heavier metal, and forms a hinged top. Patterns are included in the blueprints.

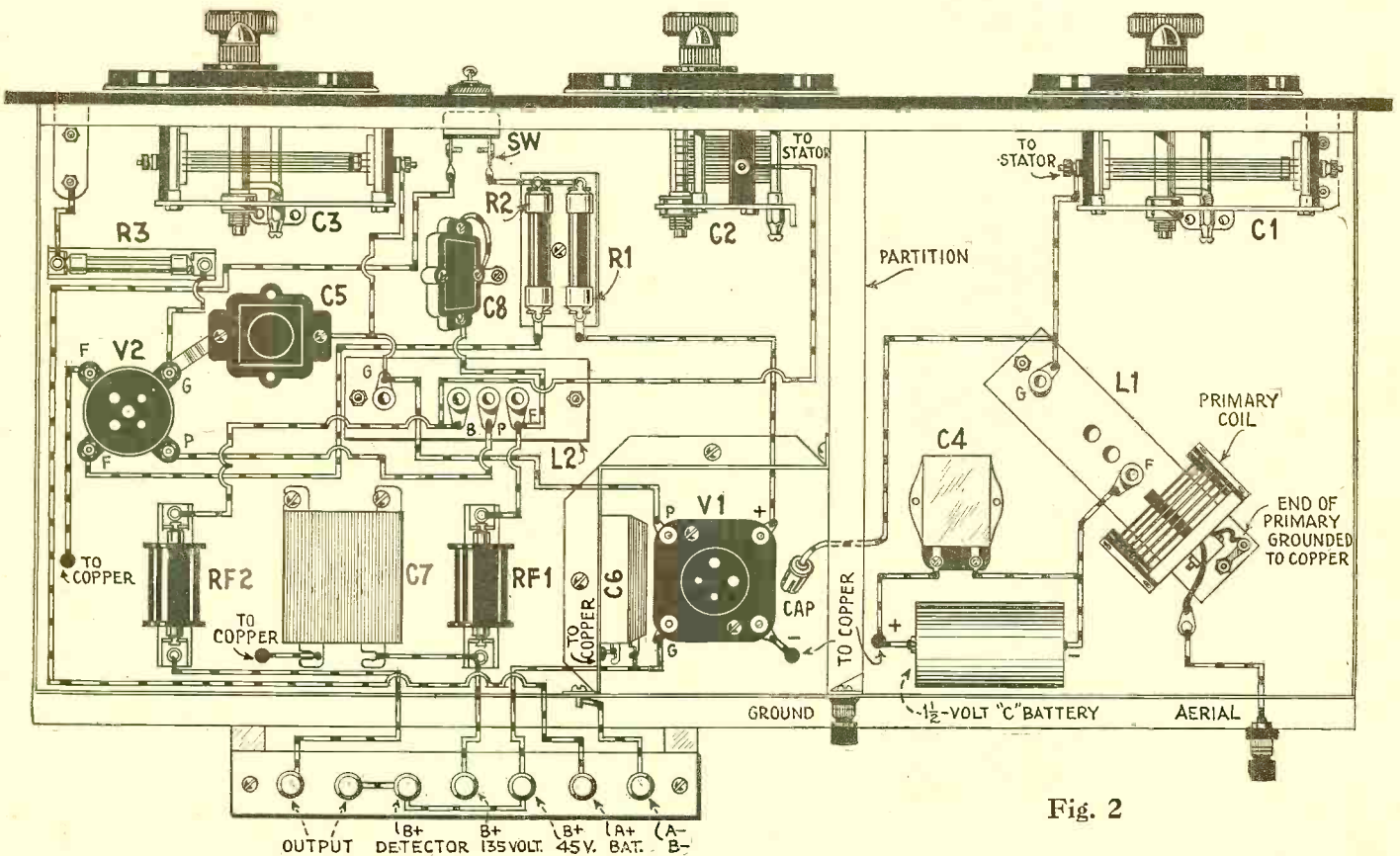
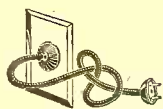

Fig. 2

Complete picture wiring diagram of the "Copperclad Special." The lead from the "G" post of L1 is a flexible wire passing through the stage partition and terminating at a cap, which in turn is pushed over the cap electrode of the screen-grid tube, V1. The "Ground" and "A—B—" connections are made to the copper shielding. The aerial post is mounted on a small upright piece of bakelite screwed to the back edge of the baseboard. Care must be taken to check all connections for "shorts."

A 250-Type Amplifier and Power Pack



Double-Deck Unit Is Unusually Compact, Convenient to Handle and Adaptable to Practically Any Receiver

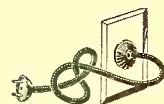

By Joseph Riley

THE custom radio builder who can sell more or less expensive apparatus to well-to-do clients desiring the best there is in radio will find the combination audio amplifier and power pack described in this article a very useful and salable device. It is comparatively compact, as large amplifiers go; and it is extremely flexible in that it may be adapted to either a 210- or, preferably, a 250-type power tube, and that it can also supply "B" and "C" voltages to even the largest receivers. It is so constructed that it may be slipped into the record compartment of a phonograph of the old-style upright type, of which there are literally millions in existence. If the phonograph itself is equipped with an electric pick-up, and a high-quality loud speaker used, phonograph reproduction equal to that furnished by the most expensive modern talking machines may be obtained. The amplifier is thrown over either to radio or phonograph by a simple two-position switch, this arrangement in no way disturbing the normal operation of either instrument.

In addition to its possibilities for profit, this amplifier is an ideal laboratory unit for the amateur experimenter. Its power-supply section is entirely isolated, mechanically, from the audio-amplifier section; thus allowing the owner to experiment freely with the latter without disturbing the power-supply end at all. All the output voltages are readily controllable, and can be changed merely by the turning of a few knobs. The power pack itself is of sufficient

capacity for the largest power-amplifier tube now available to the set builder; namely, the 250-type. In addition, it will supply all the incidental "B" current necessary for the operation of the tubes in any radio-frequency amplifier.

ADVANTAGES OF THE POWER TUBE

If the 250-type tube is used, the amplifier will be of the most advanced design, and capable of high-quality reproduction of radio and phonograph music at exceptionally high volume levels. Of course, the fact that a great deal of power is available does not necessarily mean that the owner of the instrument must annoy the neighbors a block away with unwanted broadcasting. *The real advantage of the power tube is its ability to handle the low notes, which require more energy than do the high notes.* As the low notes give that pleasant "roundness" to reproduced music, the amplifier, incorporating the most powerful tube, will prove to be a generally desirable and satisfactory instrument.

In the original model constructed in the RADIO NEWS laboratories, the amplifier consisted of two stages using the new Clough-type audio-coupling units (described on page 311 of RADIO NEWS for October, 1928) with a 227-type tube in the first stage and a 250 in the second and output stage. The reproduction afforded by this combination is probably as good as can be obtained with any radio apparatus now on the market. All the people who listened to the amplifier per-

form, both in the laboratory and in the home of one of the editors, remarked on its naturalness and clarity, even when it was tuned up so loud as to make the windows rattle. The tests were conducted with three loud speakers; an 18-inch magnetic cone, a 3-foot square double-surface linediaphragm speaker (described on page 1013 of RADIO NEWS for March, 1928) and a dynamic of the latest design.

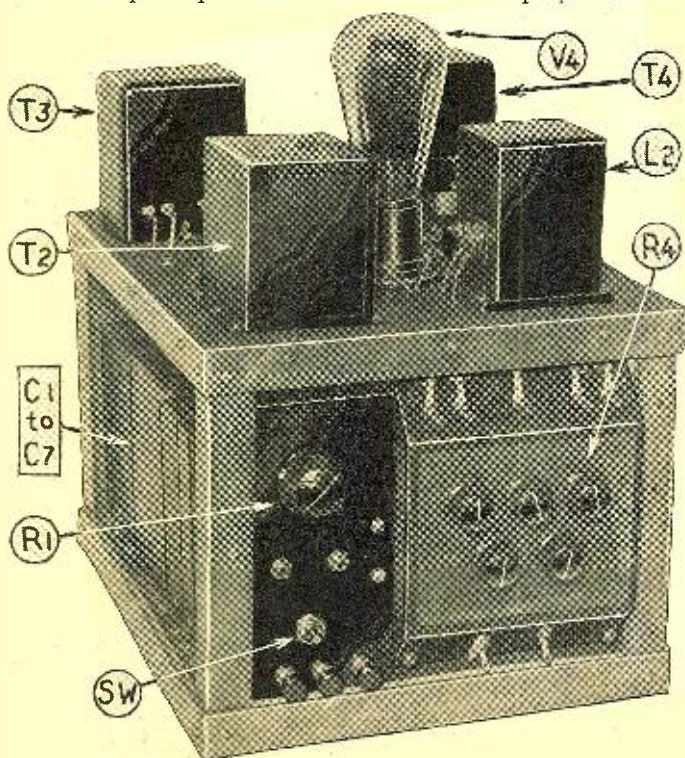



Fig. A

Front view of the completed unit, showing the amplifier (top) the condensers C1-C7, the control panel and the voltage divider R4.



No. 74

A set of large blueprints showing all the constructional details of this amplifier and power pack will be sent free of charge to any reader who intends to make the instrument. A list of the parts used in the original model is included with the blueprints. Turn to page 770 and use the coupon printed thereon; no blueprints will be sent without it.

Some rather extraordinary results were obtained when the speakers were connected in pairs and, finally, all three together. This, incidentally, is a good stunt for the radio set owner to try (that is, if he has more than one speaker available). The small cone is particularly good on the high notes and the linediaphragm speaker on the low; when the two were connected in series, the reproduction was simply extraordinary in its fidelity and volume.

THE DOUBLE-DECK CONSTRUCTION

The construction of the 250 amplifier will not present any particular problems to the custom radio builder or experimenter. The unique feature of the instrument is its double-deck design. The high-voltage power transformer, the rectifier tubes, and the filter condensers and filter chokes are all mounted on a wooden baseboard 13 inches long and 11 inches wide. The components of the audio amplifier are mounted on a board of exactly the same size raised about 9 inches above the first by means of four brass angle supports, one in each corner. It is this double-deck arrangement which makes it possible to fit the amplifier very nicely into the narrow record compartments of the old-style phonographs. Practically all other amplifiers of the 250 type described heretofore are spread out over large boards and cannot be disposed of very easily; they must usually be hidden behind a chair in a corner of the room, or special cabinets of large and awkward dimensions must be provided for them.

Because of the weight and bulk of the various transformers and condensers, it is necessary to brace the chassis with brass strips, to prevent it from bending out of shape when it is picked up or moved around. The cutting and bending of the brass can be done quite easily with the aid of an ordinary hacksaw, a vise and a heavy hammer.

The constructor who desires to avail himself of the multiple advantages of a 250 amplifier and power pack has, probably, much of the necessary material on hand. Following is a complete list of the necessary parts, each identified by a distinct sym-

bol which appears in all the illustrations and working drawings. A list giving the names of the manufacturers of the parts used in the original model is supplied with the free blueprints, which readers of RADIO NEWS can obtain by using the coupon on page 770 of this issue.

THE NECESSARY PARTS

- One power transformer T1 to supply one 250-type power tube; has center-tapped secondary developing 550 volts across each section; also two center-tapped 7½-volt filament windings;
- One filament-lighting transformer T2, with a 2½-volt secondary to supply a 227-type tube;

- Two wooden baseboards, 13 x 11 x ½ inches.
- Eight feet of brass strip, 1-inch wide by ⅛-inch thick;
- Four pieces of brass angle strip, 1 x 1 x ⅛-inch thick; each piece is 9¼ inches long.
- One insulating panel, 7 x 4 x 3/16 inches;
- Assorted wood and machine screws.

STARTING THE ASSEMBLY

The general construction and assembly of the amplifier is made clear by the various accompanying illustrations and drawings. The best procedure to follow is this:

First, obtain the two baseboards and true them up so that they are both exactly the same size. In each of the four corners cut an "L"-shaped notch, an inch long on each side and ⅛-inch deep. These notches are to accommodate the ends of the brass angle members which support the top amplifier board above the lower power-supply board. Cut the 1-inch flat brass strip into two pieces, each 4 feet long. Bend each piece into a rectangle so that it will fit snugly

supports when the amplifier is finally assembled. Also, drill three holes along the front side of the left front upright; these are to pass screws which will hold the control panel in place. The perspective drawing, Fig. 1, shows the general arrangement and the assembly of the chassis very plainly.

Drill and tap the ends of the four brass angle members with holes to correspond with those previously drilled in the corners of the flat brass strip. Assemble the chassis as shown in Fig. 1, merely to test its fit; then remove the corner pieces and you are ready to mount the various transformers and condensers.

The layout of the parts of the power-supply unit is clearly indicated in Figs. B and 4. The various condensers C1, C2, C3, C4, C5, C6 and C7 are lined up in a row along the long left-hand edge of the bottom baseboard. The power transformer, T1, is set in the back corner at the right, and the double choke coil, L1, about 2 inches in from the front edge. The two sockets, S1 and S2, for the rectifier tubes, are mounted between the transformer and the choke. Do not fail to leave this 2-inch distance between the back of the choke coil and the front edge of the baseboard, as the voltage divider R4 and the control panel must be fitted in this space. Because of their weight, the transformer and the choke coil should be fastened down with 8-32 machine screws passing completely through the baseboard and tightened on the underside with nuts. The condensers and tube sockets, being lighter, can be fastened down with wood-screws.

HINTS ON WIRING

Before proceeding any further, wire up as much of the power pack now as you can. Bring out long leads from one of the filament windings and from the high-voltage secondary of the power transformer before screwing down the two large 4-mf. filter condensers; as these condensers block these transformer binding posts. After soldering the leads to the posts, you can fasten down the condensers permanently, and will then be able to complete the connections without difficulty.

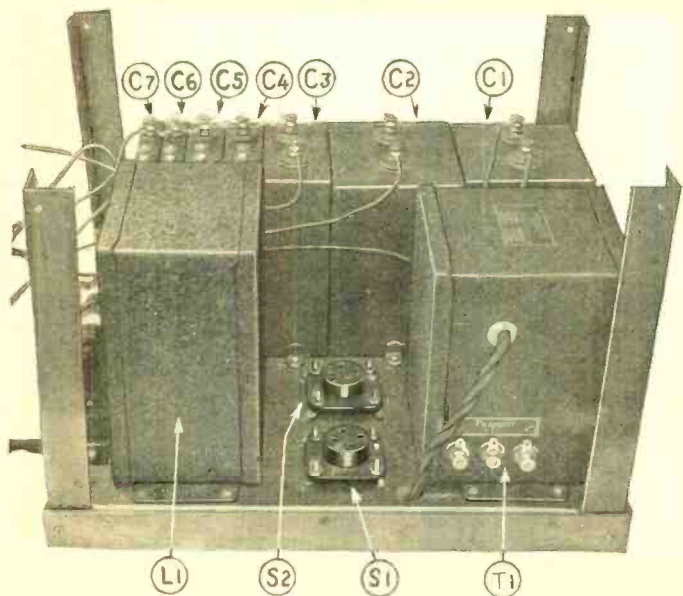

Fig. B

The half-completed unit, with the power-pack components in place. T1, power transformer; S1, S2, sockets for rectifiers; L1, choke coil.

- Two Clough-type A.F. coupling units, T3 and T4;
- One double-filter choke L1, for use in rectifier circuit; to handle current for 250 tube;
- One 30-henry output choke L2, to handle 55 milliamperes; for use in 250 plate circuit to loud speaker;
- Two filter condensers, C1, C2; 4-mf. capacity each, 1,000-volt rating;
- One filter condenser, C3; 2-mf. capacity, 1,000-volt rating;
- Three by-pass condensers, C4, C5, C6; 1-mf. capacity, 400-volt rating;
- One blocking condenser, C7; 1-mf. capacity, 600-volt rating;
- Two by-pass condensers, C8, C9; ½-mf. capacity, 180-volt rating;
- One potentiometer, R1; 5,000 ohms, to carry 60 milliamperes; with sliding contact-arm;
- One resistor, R2; 2,000 ohms, to carry 55 milliamperes; with adjusting clip;
- One resistor R3; 2,000 ohms, to carry 10 milliamperes; with adjusting clip;
- One voltage divider, R4. This is a special resistor unit enclosed in a bakelite case and fitted with five control-knobs for "B" and "C" voltages;
- Three four-prong, UX sockets, S1, S2, S4;
- One five-prong, UY-type tube socket, S3;
- Two 281-type rectifier tubes, V1, V2;
- One 227-type amplifier tube, V3;
- One 250-type amplifier tube, V4;
- One single-pole, double-throw toggle switch, SW;
- Two tip jacks;
- Five binding posts;

around each of the wooden boards. This will take a little bending and hammering; but brass is easily worked and will give no trouble. *To anneal the brass before bending it, heat it to a dull cherry red in a gas flame, and then plunge it quickly into cold water;* this treatment will harden iron, but it softens brass and makes it very workable. Drill a series of holes along each of the strips, and fasten the latter to the wooden boards with ¾-inch wood-screws. Set the boards flush with the top edges of the strips.

When drilling the strips, do not fail to include two holes in each of the corners. These are to accommodate short machine screws, which will pass into the brass corner

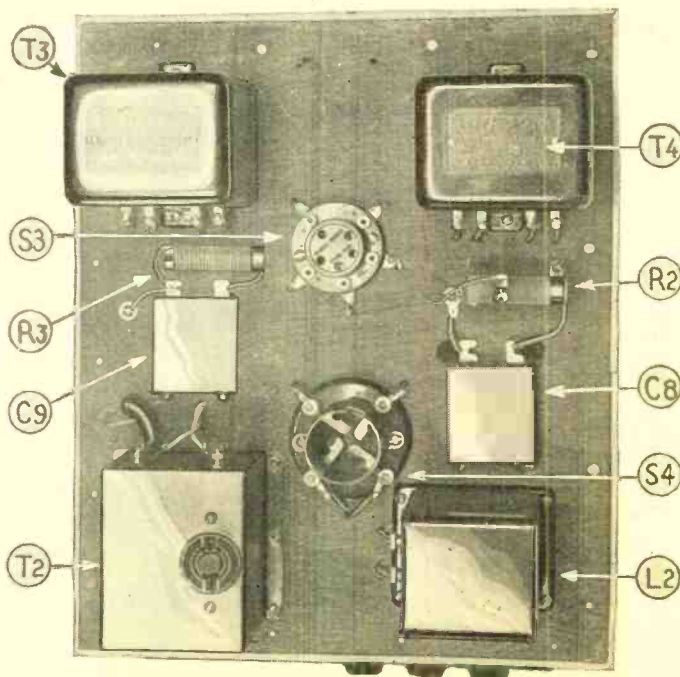

Fig. C

Top view of the amplifier board, showing the neat arrangement of the parts. There is plenty of room for an additional stage of amplification, if this is desired.

T1 and T2. No on-off switch for the 110-volt circuit is provided; because the radio receiver itself usually is equipped with a switch which can easily be made to control the power pack. It is not good practice to have separate switches, as the owner of the set is quite apt to leave one of them turned on when he shuts the other off for the night.

ADJUSTMENT AND OPERATION

Because of the high voltages and comparatively high currents involved in the operation of a 250 amplifier, the instrument must be tested and adjusted with great care if the best results are to be expected. First of all, you *absolutely must* equip yourself with a high-resistance voltmeter of the kind designed for "B" power-pack service. The most popular meters of this type have two scale readings, one from 0 to 50 volts and another from 0 to 250 volts; they are of such high resistance and take so little current for their own operation that they do not affect the voltages they are designed to measure. Ordinarily cheaper voltmeters are not suitable for the purpose, because some of them draw as much current as the whole radio set itself.

When you are playing with a rectifier circuit developing as much as 700 or 750 volts on open circuit, and producing voltages all the way down to 22, through a divider, you simply must have an accurate and dependable measuring instrument; otherwise you are completely lost. If you

is increased to 450 volts and the grid bias to 84 volts, the plate current will remain the same, but the output rating will increase to 4,650 milliwatts, more than any radio set owner will ever have occasion to take advantage of. The first-stage amplifier tube, V3, which is of the 227 type, will operate satisfactorily with 90 volts on the plate and with a grid bias of 6 volts.

The voltage developed across the ends of the filter circuit (that is, between L1 and C3) is usually in excess of 450 volts; so some means must be provided for cutting it down. The resistor R1, acting as a potentiometer, accomplishes this purpose; the entire 5,000-ohm resistance of this unit is left permanently in the circuit to cut down the voltage supplied to the voltage divider R4. This, in turn, is intended to furnish voltages between 22 and 180; so that an additional 5,000-ohm resistor is just about right.

When the amplifier is placed in operation, the voltage developed between posts 1 and 5 on the voltage divider should be not more than 220 volts, and not less than 200; if it is less than 200, loosen one of the connecting bands on resistor R1 and move in about 1/8-inch. This will reduce the effective resistance of R1 and will increase the voltage across the divider, R4.

With 200 or 220 volts across R4, the three upper adjusting knobs on the divider can be adjusted to give 150 volts at post 2 for the first amplifier tube, V3; 90 volts at post 3 for the R.F. tubes in the radio receiver;

and 45 volts at post 4 for the detector tube, which is fed through the coupling resistor in the first transformer, T3. A voltage of 150 fed to the tube V3 through the coupling resistor in T4 actually drops to 90 on the plate of the tube, because of the voltage drop across this resistor.

To prepare the amplifier and power pack for operation, connect the binding post marked "radio" to the plate of the detector tube of any broadcast receiver. Snap the toggle switch SW, so that this binding post is connected to the transformer, T3. If you are using a magnetic-type loud speaker, short-circuit the two binding posts marked "D" and connect the speaker to the two tip jacks on the control panel. Set the knob of R1 so that the contact arm is touching about the center of the resistor. Set the three control knobs on R4 so that their arrows are pointing directly upward. Loosen one clip on the biasing resistor R2 and move it over so that only about two-thirds of the resistance is in the circuit. Leave all of the 2,000 ohms of the biasing resistor R3 in the circuit.

INCREASING THE VOLTMETER'S RANGE

Now, before putting the whole works into operation, it will be necessary for you to increase the range of the voltmeter; as it goes now to only 250 volts, while you may have to read values three times as high. The writer found that an ordinary 250,000-ohm resistor connected in series with the meter

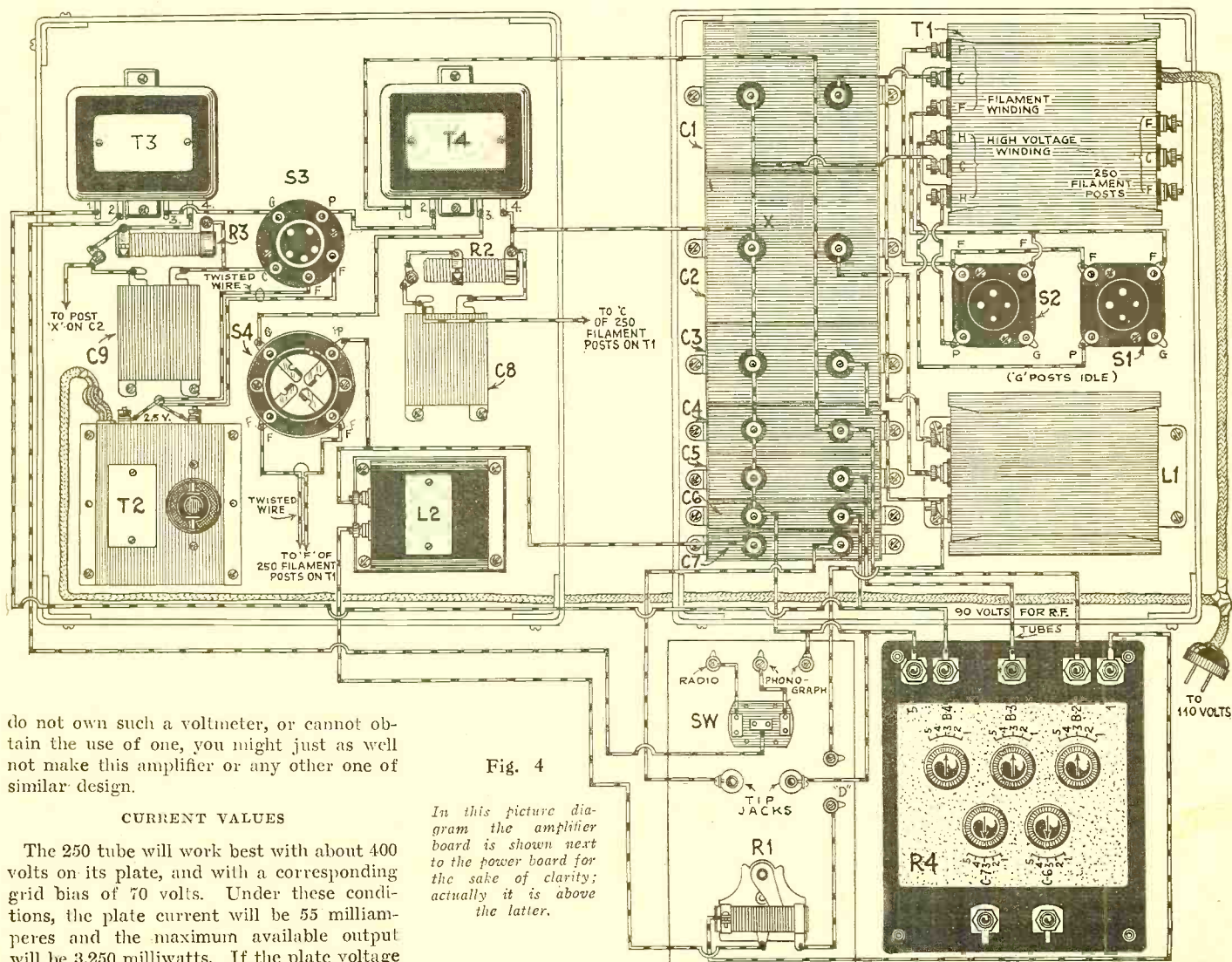

do not own such a voltmeter, or cannot obtain the use of one, you might just as well not make this amplifier or any other one of similar design.

CURRENT VALUES

The 250 tube will work best with about 400 volts on its plate, and with a corresponding grid bias of 70 volts. Under these conditions, the plate current will be 55 milliamperes and the maximum available output will be 3,250 milliwatts. If the plate voltage

In this picture diagram the amplifier board is shown next to the power board for the sake of clarity; actually it is above the latter.

tripled the scale reading. He first connected the meter *without the resistor* across two "B" batteries, which gave a reading of exactly 90 volts. After the insertion of the resistor the meter read only 30 volts.

A variable resistor of the so-called "universal" type may also be used as a "multiplier," providing you have a source of known voltage to test against. If you haven't a set of "B" batteries on hand, connect the voltmeter by itself between posts 5 and 3 on the divider, and then turn the set on. Adjust the center knob on the divider until you get a reading of exactly 90 volts; then insert either a 250,000-ohm grid leak or a variable resistor, and see what the reading falls to. With the variable resistor you can turn the knob until you get exactly 30 volts. Then you can use the meter to measure up to 750 volts; that is, when the needle points to 250 volts, the voltage will actually be 750.

Leave the negative side of the meter connected to post 5, and connect the positive side to the plate of tube V4. Adjust the resistor R1 until the meter indicates 470 volts. If we assume that the biasing resistor R2 has been adjusted to the correct value, this will mean that the tube is being operated properly. That is, the voltage on the plate is actually only 400, since there is a drop of 70 volts across the biasing resistor, R2. Because of the connections of the circuit, the grid assumes this 70-volt bias in relation to the filament.

To determine whether or not the biasing resistor is properly adjusted, merely short-circuit the multiplying resistance you have in the meter circuit, and connect the meter across R2. It will then read, directly, the amount of voltage drop across it. By moving the clip on R2 back and forth and noting the voltmeter readings, you can easily strike the proper balance.

Follow the same procedure in adjusting the plate voltage and grid bias on the first audio tube V3. With the voltmeter connected between post 5 of the divider and the plate, the reading should be 96 volts; which will take into account a 6-volt drop through the biasing resistor R3. It will probably be necessary to use the full 2,000-ohm winding of the resistor, although, of course, it is wise to experiment. Do not be misled into reading the voltage between the post 2 on the voltage divider and the negative side of the rectifier circuit; as mentioned, there is a considerable voltage drop through the resistor in the transformer T4.

The voltage to be applied to the detector

tube from post 4 on the divider through the resistor in transformer T3 will be determined by the requirements of the particular type of tube used in the receiver. A little experimenting with the upper left knob on the divider will determine the best position.

The bottom-half of the divider, which consists of a 1,000-ohm resistor fitted with two adjustable contact arms, is not used. However, if it becomes necessary to supply additional biasing voltages to the grid of other tubes, use can be made of this resistor.

SPEAKER AND PHONOGRAPH PICK-UP

The two binding posts marked "D" in the schematic diagram are short-circuited when a loud speaker of the magnetic type is used; the short-circuiting link is removed if it is desired to use a dynamic speaker and to energize the field winding of the instrument by making use of the current flowing in the "B" circuit. Because of the resistance of the field windings of a D.C. dynamic speaker, there is a drop across them of about 90 volts, the actual figure depending on the particular make of speaker. Of course, if the field of the speaker is connected in the circuit, it is necessary to make readjustments on the potentiometer, R1; you will probably have to turn the moving arm completely off the resistance winding, so



Fig. D

How the completed unit looks from the side. The rectifier tubes fit between the transformer T1 and the choke coil L1.

that it makes contact directly with the wire leading from one of the "D" posts. You will probably have also to move over one of the end clips on the resistor, in order to decrease the effective resistance of R1, and

to balance properly the voltages across the divider, R4. This sounds like a complicated operation but, as a matter of fact, it can be performed in a few minutes with the aid of a voltmeter.

The phonograph pick-up unit may be connected permanently to the two binding posts marked "phonograph"; to switch from radio to phonograph, it will then be necessary only to snap the toggle switch SW in the proper direction.

VENTILATION IS REQUIRED

The experimenter or constructor who has never used the 250 power tube before may become alarmed over the amount of heat it develops. This is no cause for fear, for the heat is the natural result of any tube's operation; even a tube as small as a 171A becomes so hot after an hour or so of use that it cannot be touched with the fingers. Similarly, the two rectifier tubes, V1 and V2, which are of the half-wave type, also become quite warm. It is a good idea to drill a few quarter-inch holes through the top board, directly above the tops of these tubes; this will allow a circulation of air and thus prevent accumulation of heat on the underside of the board.

If you are particularly fond of any special type of audio-amplification system, you can readily incorporate it into this amplifier by merely changing the coupling units; everything else will remain the same. For instance, you may have a pair of pet transformers that you think superior to anything else; you can easily install them by simply connecting their primaries to the transformer posts marked 1 and 2 in the schematic diagram and the secondaries to the posts marked 3 and 4. There is plenty of room on the top board for an additional tube, if you wish to install three stages of amplification. In fact, the first experimental model of this amplifier used a three-stage resistance-coupled amplifier; and there was plenty of room for everything. Tubes of the 227 type were used in the first two stages, the same filament transformer T2 being employed to light their filaments.

A tube of the 226 type may be used in the V3 position, if the constructor so desires. However, it will be necessary to use a potentiometer across the filament circuit and to bring the biasing resistor R3 to the arm of this potentiometer, in the same manner that the biasing resistor R2 is connected to the center tap of the filament winding for the 250 tube. The 227 tube is preferable because it introduces less hum.

Hints on Operation for the Short-Wave Beginner

WHEN the receiver goes in and out of oscillation with a squawk, or a loud cluck, experiment with various grid-leaks until you find the proper value which will allow the receiver to go into oscillation smoothly. Obstinate cases can be cured, generally, by reducing the detector plate voltage.

When wiring the receiver always connect the rotor (movable) plates of the tuning and regeneration condensers to the filament return of the stage.

Power units, of both the "A" and "B" types, are *not recommended* for use with short-wave receivers. A good "B" power unit is entirely satisfactory when used with a broadcast receiver; for the simple reason that, should a slight A.C. ripple be present in the speaker, it will not be noticed be-

cause of the volume of the reproduced signal. However, listening to a very weak signal with headphones is another matter; in this case A.C. ripples which would be inaudible in a broadcast receiver become literally roars in the phones. It should be remembered, also, that the broadcast receiver is, or should be, operated below the point of oscillation; this is quite a factor in keeping the A.C. ripple down to a minimum. In using a short-wave receiver, as the regeneration control is advanced, the ripple is amplified in direct proportion to the signal.

An efficient vernier dial must be used on the tuning condenser of a short-wave receiver. This refinement is not essential on the regeneration condenser; but tuning on the high frequencies is so critical that often

signals are passed over without the operator being aware of their presence. This statement, also, emphasizes the necessity of slow and deliberate tuning, when a mere slight pressure on the knob of the dial may bring in a station.

It should be remembered that short-wave receivers can be logged—not quite as easily as the stabilized broadcast-wave receiver; but with a fair degree of reliability. After a station has been tuned in to the point where it is loudest, turn the regeneration dial to as low a point as it can be brought without losing the signal; when this has been reached, adjust the tuning condenser until the signal is loudest. At this dial reading the station may be logged; with some assurance of returning to it, when desired, with a minimum of "juggling."

Constructing a Modulated Oscillator^{*}

A Piece of Apparatus Which Every Radio Constructor Should Have, Especially If He Is In the Business, and Which Can Be Made at Trifling Cost With Little Labor.

By John B. Brennan, Jr.

The Constructor's Friend

THE custom radio builder or advanced experimenter who assembles the simple modulated oscillator described in this article will soon find it the most useful instrument on his test table. It can be applied to a wide variety of important purposes, and possesses the further advantage that it may be constructed, mostly, of odd parts such as are always to be found in the junk box under the work-bench.—EDITOR.

THIS article outlines the construction of a combination radio-audio-frequency oscillator which will be exceedingly useful to the professional set-builder and radio experimenter; because it will enable him to make quick, effective tests on the receivers he builds, and to check as well the relative efficiency of the various pieces of apparatus employed in the construction of such receivers.

Not so many years ago it was a common practice to test the receptive qualities of a receiver by hitching up a buzzer in the antenna circuit, and noting whether there was a response in the phones attached to the receiver. While this method was crude, nevertheless it was more or less effective. To calibrate a receiver required the use of

a wavemeter fitted with a buzzer; so that the tone of the buzzer could be picked up on the receiver to be tested, at the particular wavelength setting of the wavemeter.

The oscillator described here does this same job (besides many others listed below) in a more efficient way. By its use, more accuracy in calibration is obtained, due to the fact that the oscillator for generating radio frequencies may be made to produce a very sharp resonance curve. Taking the place of the old buzzer as a means of generating an audio tone is the audio oscillator, which is coupled to the radio oscillator; so that the wave of the radio-frequency oscillator may be modulated and therefore picked up on any receiver.

Such an instrument is useful in the following ways: as a radio oscillator, it may be used as a heterodyne wavemeter, as a radio-frequency generator or driver, to measure the gain per stage of a radio-frequency amplifier, to measure the frequency range of radio-frequency amplifiers, to determine the tuning range of experimental coils, and to measure the frequency range of coil-condenser combinations. As an audio oscillator, the instrument is useful as a source of tone (for testing the continuity of receiver circuits), for measuring capacity, inductance and resistance, and for measuring the over-all gain of audio-frequency amplifiers. When used as a combined radio-audio oscillator (otherwise known as a modulated oscillator) it may be used with



**RADIO NEWS
FREE
BLUEPRINT
ARTICLE**

No. 75

A set of blueprints, together with a list of the manufactured parts used in the construction of the original model of the Modulated Oscillator illustrated here, will be sent postpaid, free of charge, to any reader desirous of constructing this device. Please turn to page 770 and use the coupon provided for our mutual convenience; no blueprints of this instrument will be sent without the coupon.

the aid of a receiver to measure unknown frequencies—as in the case of short-wave reception, where it is desired to know the frequency adjustment of an amateur short-wave station—for measuring the tuning range of receivers, and for setting a receiver to a known frequency.

COMPACT AND VERSATILE

In the particular instrument described here, three-volt tubes have been employed, in both the radio and audio oscillators; because they render very satisfactory service over a comparatively long period of time and require only one 4½-volt "C" battery for filament illumination and one 22½-volt

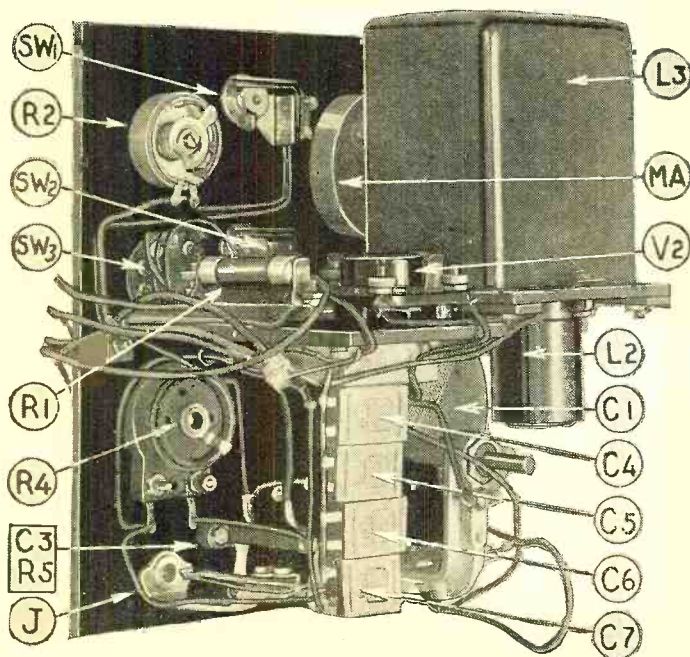

A rear view of the panel of the modulated oscillator, with its two shelves, removed from the case. The position of all the apparatus is visible here—compare Figs. 4 and 5. If it is so desired, the box may be made deep enough to contain the needed dry batteries.

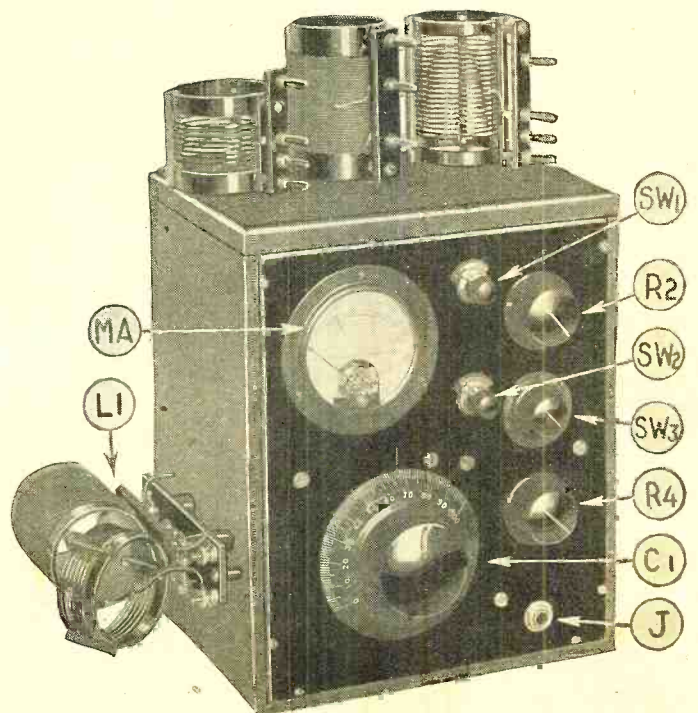

A front view of the modulated oscillator in its cabinet. The spare coils on top may be readily substituted in the position L1 as needed.

*RADIO NEWS Free Blueprint Article No. 75. (See page 770.)

"B" or "C" battery for plate supply. If the instrument cabinet is deep enough, these batteries may be placed inside; if not, they may be fastened by brackets to the rear outside wall of the cabinet.

For obtaining accurate resonance indications a 0-1½-scale milliammeter is included in the grid circuit of the radio oscillator. In operation a sharp dip of the needle of the meter will indicate resonance when the oscillator is coupled to the receiver or coil to be measured; by loosening the coupling a more accurate resonance indication will be obtained.

With interchangeable plug-in coils (L1) in the radio oscillator and a single tuning condenser (C1), it is possible to obtain a frequency range from 15 meters to 550 meters. If it is desired to go higher than this then, by shunting a .0001-mf. fixed mica condenser across the tuning condenser, the range may be extended to 725 meters.

The audio oscillator has a closed-circuit jack located in its plate circuit; so that a pair of phones may be plugged in, to hear the nature of the tone. By means of a switch connected to four condensers of the fixed type (C4, 5, 6 and 7), it is possible to obtain four different audio tones. The four condensers listed in the parts list are satisfactory for general purposes but, if the builder desires to obtain a tone of a certain frequency, he will have to experiment for himself with other condenser values until the desired tone is obtained.

CONSTRUCTION AND ASSEMBLY

The instrument built by the author and illustrated here utilizes a panel 7¼ inches wide by 8⅝ inches long; simply because that size of cabinet was available. There is no reason, of course, why a panel and cabinet of larger size may not be used; simply maintain the same general layout of the instruments on the panel, as shown in the accompanying diagrams.

After all the parts listed below have been acquired, tighten the various terminals

to prevent loosening after assembly. Then, drill the panel in accordance with the layout shown, Fig. 3. Prepare two pieces of bakelite to serve as shelves to support the tube sockets, amperites, output transformer, etc. Next, cut four brackets from ⅛ x ½-inch brass strip and bend; then drill to take the shelves, and mount on the main panel. After this the apparatus may be mounted in place and wiring begun. Holes are drilled through the side wall of the cabinet to allow connection to the base of the plug-in coil mounting which has been previously mounted thereon.

PARTS REQUIRED

- One variable condenser, .0001-mf. (C1);
- One by-pass condenser, 1-mf. (C2);
- One fixed condenser, .0001-mf. (C3);
- One fixed condenser, .00015-mf. (C4);
- One fixed condenser, .0005-mf. (C5);
- One fixed condenser, .0015-mf. (C6);
- One fixed condenser, .01-mf. (C7);
- Two amperites, 4-volt, 60-milliamper (R1, R3);
- One rheostat, 10-ohm, (R2);
- One variable resistor, 0-500,000 ohms (R4);
- Two battery switches, (SW1, SW2);
- One 4-point inductance switch, (SW3);
- One plug-in-coil kit (five coils to cover wavelengths from 16 to 550 meters, L1);
- One R.F. choke coil, 85 millihenry, (L2);
- One A.F. push-pull output choke; (L3);
- Two UX-type sockets, (V1, V2);
- One closed-circuit jack, (J);
- One vernier dial;
- One grid leak, 0.5-meg. (R5);
- One single-resistor mount;
- Two 199-type tubes;
- One panel, 8⅝ x 7¼ x 3/16 inches; and cabinet;
- One 4½-volt battery, one 22½-volt battery;
- One box hook-up wire; miscellaneous bakelite and brass strip.

COIL DATA

A set of seven plug-in coils is necessary to make the modulated oscillator cover

wavelengths from 16 to 577 meters, a range that takes in everything the short-wave experimenter, custom radio builder or general experimenter is interested in. Inexpensive manufactured coils of the proper sizes are available, and it is recommended that the builder of the oscillator purchase these, as more uniform results will usually be obtained. However, if he wants to make his own inductors, with a slight variance in the tuning ranges, he can use the following data.

All the coils are two inches in diameter and, if home-made, should be fitted with three plugs to fit a simple mounting, which consist of a bakelite strip with three socket receptacles. Coil 1, as manufactured, has four turns of No. 16 or 18 enamelled wire, the turns being spaced a distance equal to the diameter of the wire; this tunes from 16 to 32 meters. Coil 2 has eight turns, similarly spaced, and tunes from 26 to 48 meters. Coil 3 has 19 turns, and goes from 46 to 89 meters. Coil 4 has 28 turns, and tunes from 87 to 155 meters. Coil 5 (all the above use wire of the same size) has 44 turns and covers the band between 107 and 204 meters. Coil 6 consists of 74 turns of No. 24 D. C. C. wire, wound tight, and goes from 170 to 337 meters. Coil 7 is wound with 125 turns of No. 30 D. C. C. wire, and covers the extreme upper band of 313 to 577 meters. All the coils are tapped in the center, as shown at L1 (Fig. 1).

If the coils are home-made, they may be wound on bakelite, hard rubber, formica, or other strong composition tubing, two inches in outside diameter and one-eighth inch or so thick. The "cut-and-try" method may be used to bring their range to the exact upper limit most desirable; but this is a matter of individual experiment on which more precise specifications cannot be given.

If coils are purchased ready-made, there is an alteration which must be made on each of the plug-in coils used. These coils, as supplied in kit form, make use of a base

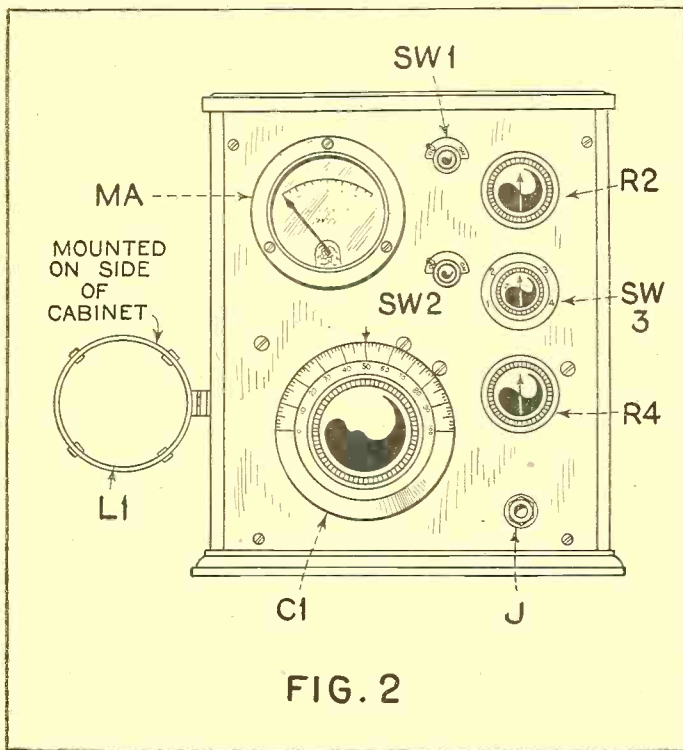
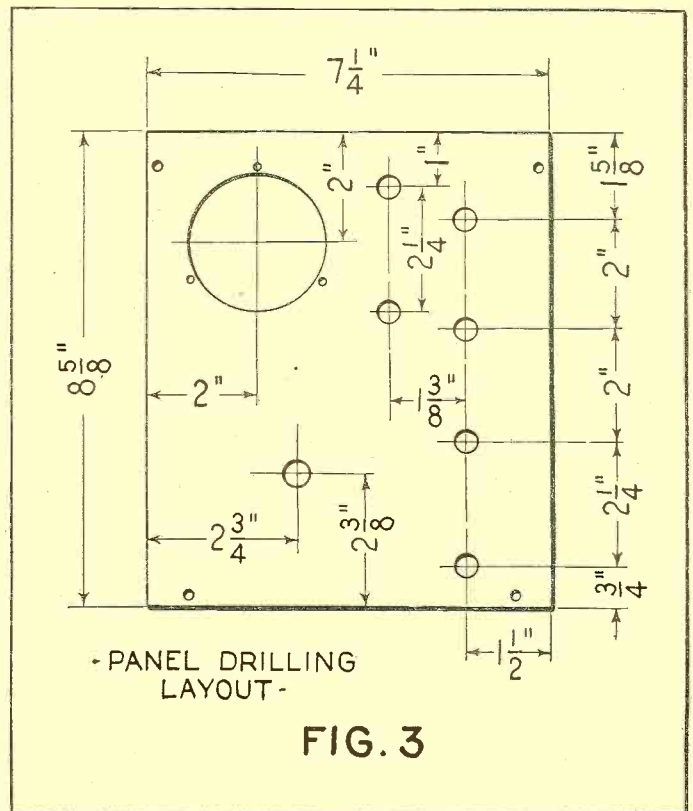

FIG. 2



PANEL DRILLING LAYOUT-

FIG. 3

The compact panel of the apparatus has the controls of two oscillators; modulated current, or either R.F. or A.F. alone, may be obtained.

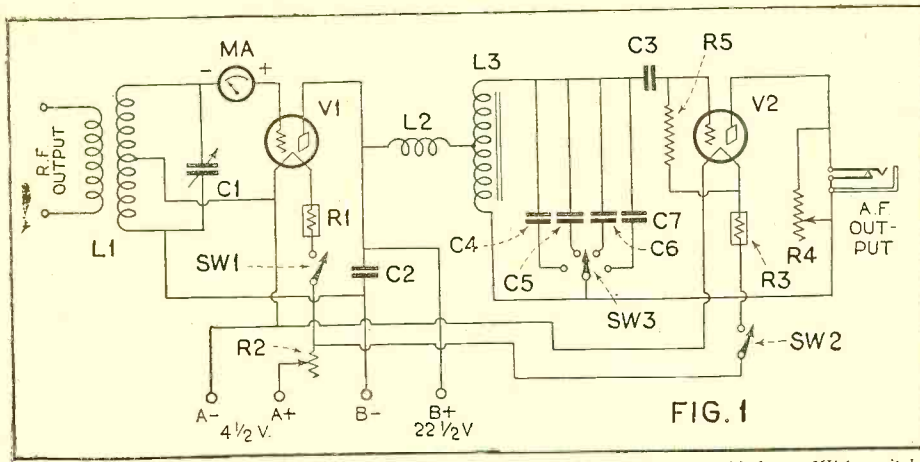

FIG. 1
This circuit affords a means of testing and adjusting radio apparatus of all kinds. With switch SW1 open, pure audio tones may be generated, one for each of the condensers selected by SW3. The modulated R.F. signal generated by both circuits together is a very convenient substitute for the "broadcast station in operation" needed to adjust sets.

mounting which holds a primary coil mounted on a hinge and four pin-jack receptacles for the various secondary-tickler coils. Since the tickler winding is not used in the oscillator circuit, either it may be removed or its leads unsoldered from its pin terminals; to one of these vacant terminals is soldered a lead, which in turn is soldered to the mid-turn of the secondary coil. This means that the builder will have to count the turns of each secondary coil and pick out the mid-turn, then make the soldered connection to it.

When coupling by means of a coil to the set under test is desired for measurement purposes, the hinged antenna coil may be used. In a majority of cases, however, it will be found that sufficient coupling is obtained by simply placing the apparatus to be measured in close proximity to the coil, which is fastened to the side wall of the cabinet.

PRINCIPLE OF THE CIRCUIT

The theory of the operation of this modulated-oscillator is simple, and may be understood from a study of the schematic wiring diagram, Fig. 1. Radio-frequency oscillations are generated in the oscillatory circuit

formed by the tapped coil L1 and the variable condenser C1, the tube V1 acting as the "driver" which keeps the circuit oscillating. The bottom half of the coil L1, from the center tap down to the end that connects to condenser C2, acts as a tickler, and performs the same function as in any regenerative hook-up. It allows the plate current of the tube to feed energy back into the grid and its associated oscillatory circuit, and serves to keep the latter going.

The condenser C2 prevents the "B" battery from short circuiting to the filament through the tickler end of the coil L1. However, it does not prevent the radio-frequency component of the plate current from flowing in the proper manner through the tickler, where it effects the aforementioned feed-back.

Just as the coil L1 and its condenser C1 generate radio-frequency oscillations, the split secondary of the push-pull output transformer L3 and its shunt condensers C4, 5, 6 and 7 generate audio-frequency oscillations. The action is the same in both cases, the only difference being in the electrical values of the components and the consequent frequencies of the generated oscillations.

The radio-frequency choke coil L2 allows the direct current of the "B" battery to reach the plate of the tube V2 through the bottom half of the winding of L3; but it prevents the R.F. component of the plate current of the R.F. oscillator, V1, from short-circuiting itself through the high self-capacity of the winding of L3 and through the plate of V2 back to the filament. However, this choke has practically no impedance (resistance) to the audio-frequency tones generated in the L3-C4 circuit; and it therefore allows the latter to modulate the R.F. current generated in the L1-C1 circuit when the A.F. tube V2 is turned on by means of switch SW2. With SW2 off, only pure radio-frequency current is generated; this current can be detected only in an oscillating receiver. The modulated current is similar in nature to a broadcast signal and, for test purposes, may be regarded as such.

The advantage of using a local modulated oscillator of this kind is that the custom radio builder or experimenter has a test "signal" of fixed value available at all times. Such a signal is more useful, in fact, than actual broadcast signals, which vary in intensity; its value being fixed, its relative effect on two different receivers or circuits can be ascertained more readily than if a fluctuating musical selection were used.

OPERATION AND CALIBRATION

Calibration of the oscillator is not so difficult as it sounds. The procedure to be followed for the broadcast band of frequencies will be explained; the same directions will serve for the short-wave band. A simple one-tube regenerative detector is all the accessory needed. Insert the broadcast-range coil in its mounting, place the oscillator near the regenerative detector (or, instead, connect the hinged coil in series with the antenna-ground lead of the regenerative detector) and then turn on both the detector and the radio oscillator. Begin at the high end of the detector tuning dial. When a station is tuned in determine its identity and wavelength. Usually this is possible by listening for the station's call letters; by referring to a newspaper or

(Continued on page 774)

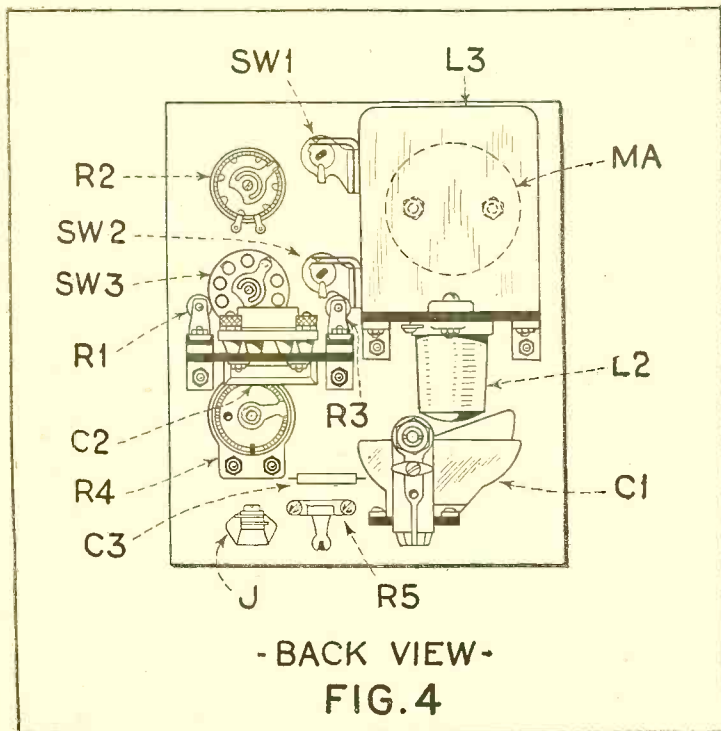

- BACK VIEW -
FIG. 4

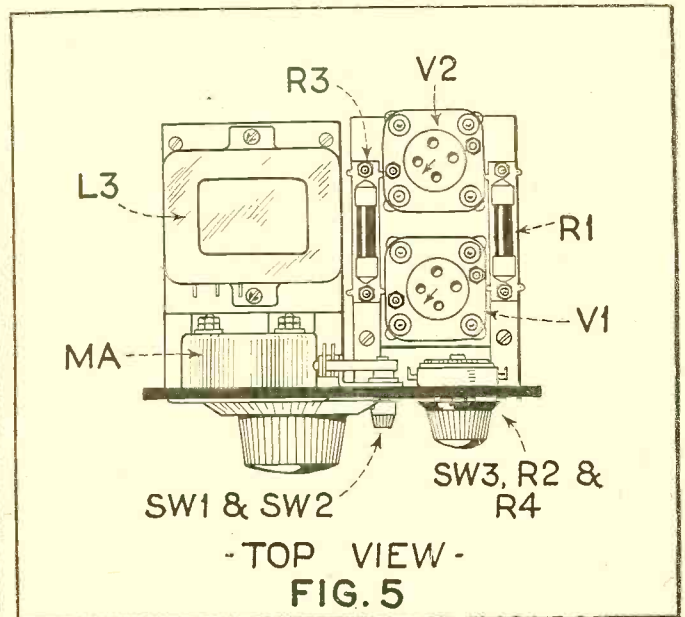

- TOP VIEW -
FIG. 5

This assembly utilizes every square inch of panel and the two bachelite shelves as shown as heavy black lines in Fig. 4. Leads from C1 to the R.F. coil L1 are very short, as the coil is mounted to the left side of the box. Condensers C4-7 are simply hung by their leads.

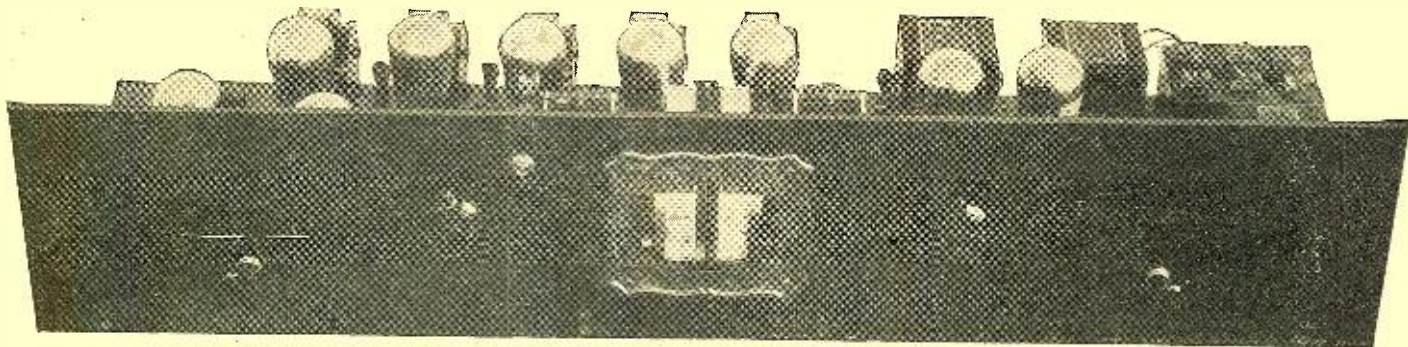

Top view of the receiver: the knobs of the stage-control switches are at the extreme left and right.

A Flexible Nine-Tube Superheterodyne

The Switching Arrangement of this Well-Designed Receiver Allows the Use of Five Tubes for Economical Reception of Local Stations

By Coleman Sutton

IN the superheterodyne illustrated here there are suggestions affording an opportunity to the experienced constructor, though no comprehensive constructional details are given; it is to be taken for granted that the set builder who undertakes the construction of a superheterodyne has a sufficient knowledge of radio to build a receiver from a few photographs, a circuit diagram and a superficial explanation of what's what regarding the circuit. On this premise, no effort has been made to enter into any minute details regarding the construction of this receiver.

Also, for the reasons outlined above, no constructional blueprints are to be made available to RADIO NEWS readers. The circuit is being published simply because of its novel features, and the interest it may hold for the constructor who has had previous experience with this type of receiver and, therefore, has acquired sufficient knowledge to build this model, if he so desires, with the information offered here.

Briefly, the set is a nine-tube superheterodyne of the conventional type, with an antenna input which can be tuned either to a loop or an aerial system. The nine tubes are distributed as follows: a first detector V1, an oscillator V2, four stages of intermediate-frequency amplification V3-4-5-6, a second detector V7, and two stages of straight transformer-coupled audio-frequency amplification V8-9. The last audio tube may or may not be a power amplifier, according to the preference of the constructor, though in the circuit diagram here the separate "B"-voltage binding post and the choke coil-by-pass condenser output-filter system show that provision has been made for a power tube.

SWITCHING ARRANGEMENTS

What may be considered the novel feature of this set is the action of the first switch, SW1, by which the intermediate amplifiers may be cut out of the circuit, for local reception. The receiver, now comprising a first detector, oscillator, second detector, and two stages of audio amplification, offers sufficient volume and selectivity when receiving nearby broadcasts.

As may be seen from the diagram, the jack-switch, SW1, is actually a combination of three S.P.D.T. switches, so constructed

WHILE it is against the policy of RADIO NEWS to publish straight regenerative circuits, or to give out information concerning them to beginners, who would probably annoy others to a greater extent than they would benefit themselves—it is our belief that any constructor sufficiently experienced to assemble this superheterodyne from the schematic diagram and make it operate, knows better than to allow its first detector to radiate and disturb the neighbors—and we therefore commend it to the well-wayed consciences of such among our readers. RADIO NEWS cannot furnish blueprints, the list of parts originally used, or constructional information other than that contained in this article, and requests our readers not to ask for them.—EDITOR.

that all three poles are actuated with the same movement.

In arranging this switching circuit, it was necessary to prevent any capacitive coupling (between the plate of the first detector and the plate of the last intermediate-amplifier tube, V6) which might be caused by the flat springs of the switch acting as a small condenser. The arrangement shown in the diagram prevents any such coupling; when it is thrown for "DX" the lead from V6, connected to the bottom lug of the switch, is opened; the spring leaf next above the bottom one closes the leaf just above it and, as this latter is connected to the "A—" circuit, the connection between the plates of the two tubes is thereby grounded. In other words, when the switch is thrown to "local," there is a solid electrical connection from the plate of the first detector, V1, to the plate of V6; but, when it is switched to "DX," this connection is opened in two places and the intervening portion between the two openings is "grounded."

The chance for any capacitive coupling is still further reduced by running the filament-control connections between the plate connections, thereby separating the latter as much as possible. In actual tests it was found that the intermediate amplifiers did

not oscillate any sooner, when the potentiometer was turned with the jack-switch in the circuit, than they did when direct connections were made with the jack-switch entirely removed. Thus, the installation of this switch provides a great saving of current when listening to local stations, and yet it does not reduce the efficiency of the circuit when receiving distant broadcasts.

AUDIO-STAGE SWITCHING

The second feature of the receiver, if it may be termed such, is the switching arrangement controlled by the jack-switch, SW2 (this switching circuit was described by the writer in the August, 1928, issue of RADIO NEWS). It will be found that, with the average run of superheterodynes, ample volume can be obtained from even distant stations when using one stage of audio-frequency amplification; but, for extreme volume, or if reception is faint when the switch is on "Soft," both audio stages may be turned on merely by turning the knob on the jack-switch to "Loud." This switch, like SW1, is of the jack type, but differs from the first in that it combines four single-pole double-throw switches. Panel-mounting jack-switches are used in both positions, so that they can be controlled from the front of the panel.

Constructional details may be gleaned from the pictures and the circuit diagram. The former show the general layout to be that of the conventional superheterodyne; that is, the straight-line method of assembly; the drum-dial type of condenser mounting is employed. The front panel, in the set illustrated, measures 7 x 33½ inches, the sub-panel 9 x 32½ inches.

The circuit is designed primarily for aerial-and-ground operation, although provision is made for a loop antenna if desired. By plugging the loop into the jack, J, the antenna circuit is automatically broken; so that, even when using the loop, the aerial and ground leads may be left connected permanently to the "B" and "P" posts of the primary of the antenna coupler L1. This device, which commonly parades under the name of "three-circuit tuner," comprises a primary (either fixed or variable), a secondary and a variable tickler. Such components are being marketed by any number of manufacturers, and all makes available

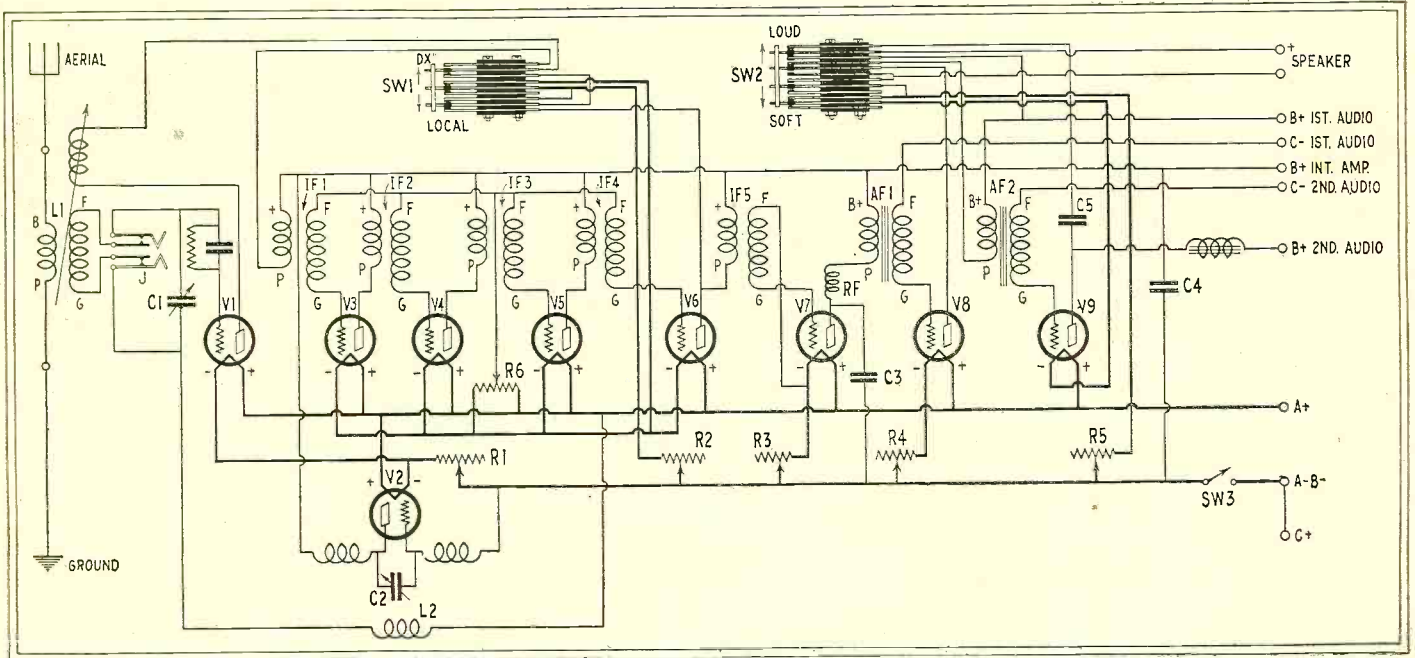

The hook-up used in Mr. Sutton's "super" is a time-tried one, made more flexible than before by the switches SW1 and SW2; the first cuts out the intermediate amplifier, for local reception; the second allows the use of a single audio stage for exceptionally strong signals.

are designed for the broadcast bands; except a few, perhaps, for short-wave operation. The particular coil used in this receiver has an adjustable primary and a variable tickler mounted on a shaft; the capacity of the variable condenser C1 must be suited to the secondary of the coupler used. In the same circuit (the antenna circuit of the first detector V1) are the grid leak and grid condenser, of the usual values.

The oscillator coupler L2, which operates in conjunction with the oscillator tube V2, usually is obtainable as part of a set when purchasing intermediate-frequency transformers; and, as a rule, is designed by the manufacturer to match the values of the latter. As with the variable condenser for the antenna coupler, the capacity of the variable condenser, C2, which is used to tune the oscillatory circuit, depends upon the specification of the oscillator-coupler; the latter is a simple component comprising three windings on a coil form.

Symbols IF1-2-3-4-5 indicate intermediate-frequency transformers, for which it would be rather unwise to give constructional details because of the care and accuracy de-

manded in the construction of these components. It is far safer to purchase these units; as the manufactured products are electrically matched in a manner which the average experimenter hardly can imitate because of the laboratory instruments required in this very important process. Also, it is highly important that all intermediate transformers be of one type and of the same make; these units are tuned to definite "frequency-peaks"; and so each transformer must be matched to this "peak." Obviously, two transformers of one rating, and two of another will not produce the desired results or anything near it. Readers who have done experimenting with superhets, also, will doubtless have transformers, coils and condensers already matched on hand.

ELEMENTS OF THE CIRCUIT

The second detector, V7, does not employ the leak-condenser method of detection, but instead makes use of the negative grid-return; as the leak-grid system, if used here, would be more easily overloaded by the amplified signal. In experimenting with the second-detector circuit it was found that, when the grid-return was connected

directly to "A—," the tube was very microphonic; but, by connecting the grid-return as shown in the diagram, so that the grid potential is zero, the tube is then practically non-microphonic, introduces no distortion in normal operation, and handles plenty of volume.

The radio-frequency choke coil RF should be placed between the plate of the second detector and the "P" post of the first audio transformer, as indicated in the circuit diagram and by-passed by the fixed condenser C3; which, though rated at .002-mf., is not critical as to value. The choke coil should have a value not lower than 80 millihenries.

Although this particular receiver makes use of transformer-coupled audio-frequency amplification, there is no reason why this system of amplification must necessarily be adhered to by the constructor; in this regard he is safe in adopting whatever system of audio amplification he may favor. The importance of following specifications in a superheterodyne may be emphasized, until the plate circuit of the second detector tube has been reached; from there on the

(Continued on page 775)

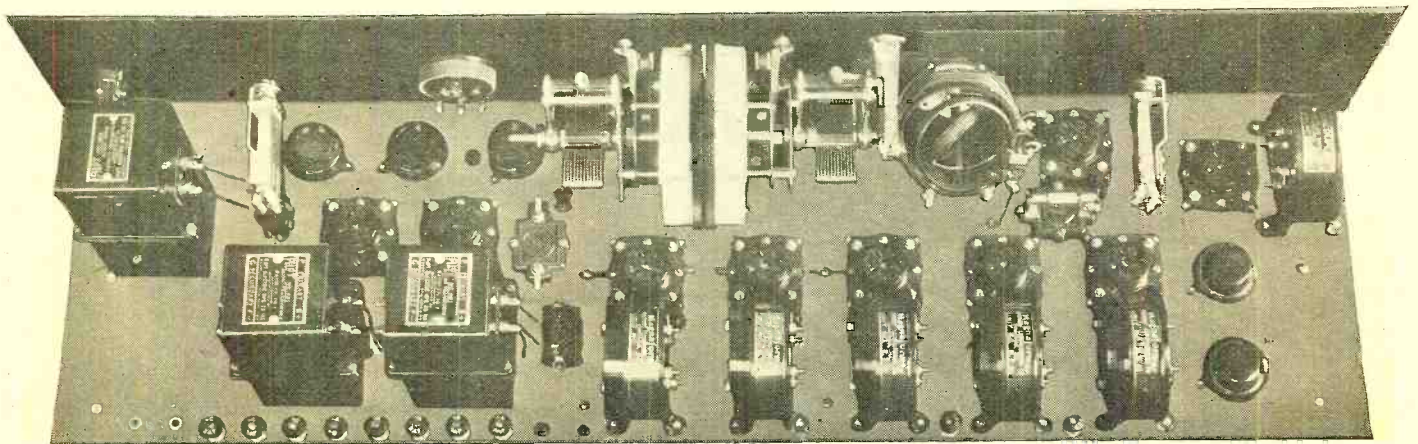

Back view with tubes removed to show the positions of all the parts: the layout is simple and symmetrical, and all the connecting wires are short and direct.

Radio Wrinkles

Converting Single Condensers Into Multiple Unit

MANY circuits have been devised wherein the tuning condensers are so coupled that they are controlled by one dial, as in the Peridyne. A New Zealand correspondent when building his Peridyne found that the tuning condensers he had on hand were not of the type specified in the constructional blueprints; and therefore set about building his own coupling device. The method followed is explained in the directions below:

First, mount the condensers on the brackets, as shown in Fig. 1; these brackets should be cut from some stiff metal, so that they will bear the weight of the condensers without giving. Mount the cranks diagrammed at A on the condenser shafts; and crank B on the drum dial, if one is used. The slot in the end of B compensates any variation from the true alignment. After the condensers and cranks have been secured and aligned properly, a 3/16-inch rod of suitable length is passed through the upper holes of the "A" group.—Contributed by R. H. Lovegrove.

A "Bug" for the Budding Ham Is Cheaply Made

EVERY transmitting amateur, not already the possessor of a transmitting key of the "side-swiping" type (also known as a "cootie" or a "bug") has long coveted one. The difference between this type and the "straight" telegraph key of the conventional type, is that with the latter the wrist movement is up-and-down; while with the former it is sideways, allowing the lever to make contact on either side. The advantage of the double-acting "bug" is that transmission may be more lengthy without tiring

the operator's wrist; also, a certain swagger or "swing," which an expert operator usually prides himself on having, is acquired with the use of this key.

The lever for such a key may be obtained from little brother's metal-strip construction set, or may be any six-inch strip of firm, flexible metal. By means of two right-angles on one end of the strip, mount it on a block of wood as shown in Fig. 2; a wire under one of the angles makes one contact of the key. The others are obtained by running a wire to the two contact-screws about an inch back of the taped grip of the strip; since the key is double-acting both screws must be arranged so that when the key touches either the circuit will be closed. Connections to the screws can be accomplished by driving them through the holes in soldering lugs and soldering the leads to these lugs. The groove in the base of the block, shown by the dotted lines, permits the key to rest flat on the table. As a finishing touch, wind some electrician's tape about the end of the strip; this will do as a grip, to make the key easier to handle.—Contributed by William Schenk.

A Resistor Holder Giving Better Contact

BREAKING one of the clips on a grid-condenser led one contributor to construct a grid-leak holder which he found

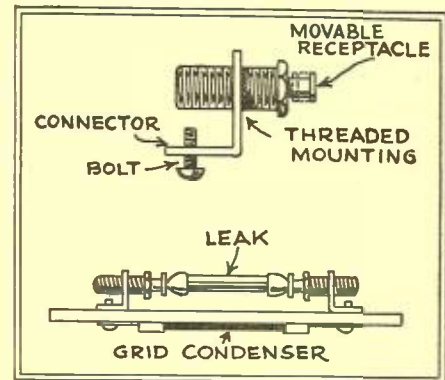

Fig. 3

The mounting device here gives satisfactory results with grid leaks of various lengths.

to be an improvement over the semi-flexible clips supplied with the grid condenser. The result of his hurried search for a substitute is made from two tip-jacks of the coil-spring variety, as shown above in Fig. 3; it will be found that the small receptacle into which the tip is inserted is kept at constant tension because of the spring behind it. Two of these were mounted as shown on a strip of hard-rubber, or bakelite. The grid leak is inserted by placing one end in the first jack and pushing it in far enough to allow the other end of the leak to go into place in the other jack. Another advantage is that the threaded portion of the jack may be used for adjustment, to accommodate cartridges of different length. Holders of this type may be used also for either filament resistors or amplifier resistors.—Contributed by Roy A. Jenkins.

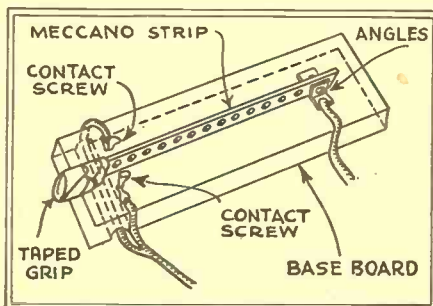

Fig. 2

Make your own key of a strip of metal; a printer's brass rule would serve very nicely.

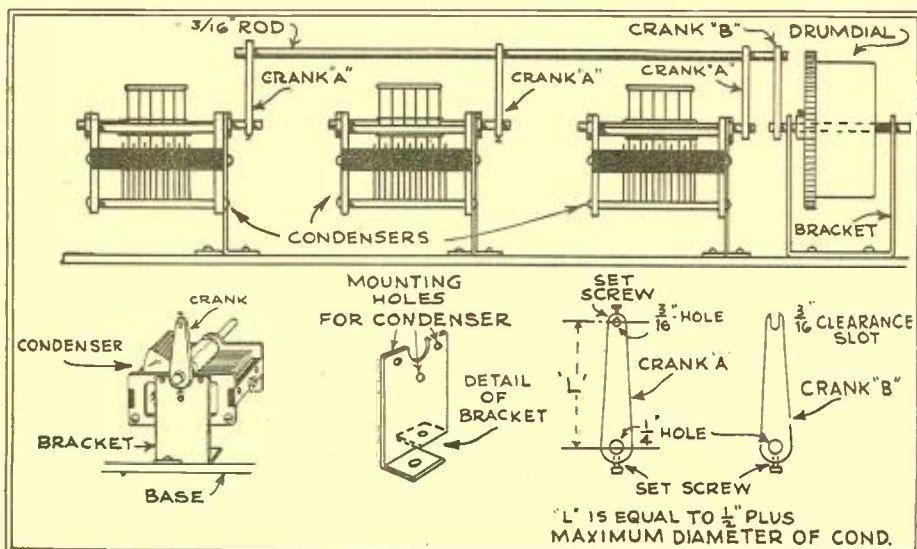

Fig. 1

With old-fashioned condensers, single control may be obtained by the use of a coupling system of the nature indicated above. The length of the cranks must suit the parts used.

Mending the Cone Speaker

THE method employed by one contributor to repair a cone speaker which had met with disaster at the hands of his young daughter may be of interest to other radio fans. Making some adjustments on the receiver, he found it necessary, during the course of the experiments, to place the speaker on the floor; in which position it must have appealed greatly to the little girl as a convertible divan for, very deliberately, she turned it over and sat upon it before papa could recover from his horror. After the salvaging operation, he recalled reading, some time back, of repairing paper cones by removing them from the framework, stuffing wet paper into the cone, arranging it in a cone of wet paper and allowing the whole to dry.

Not having time for this process, he tried, with many doubts an experiment which, at

(Continued on page 770)

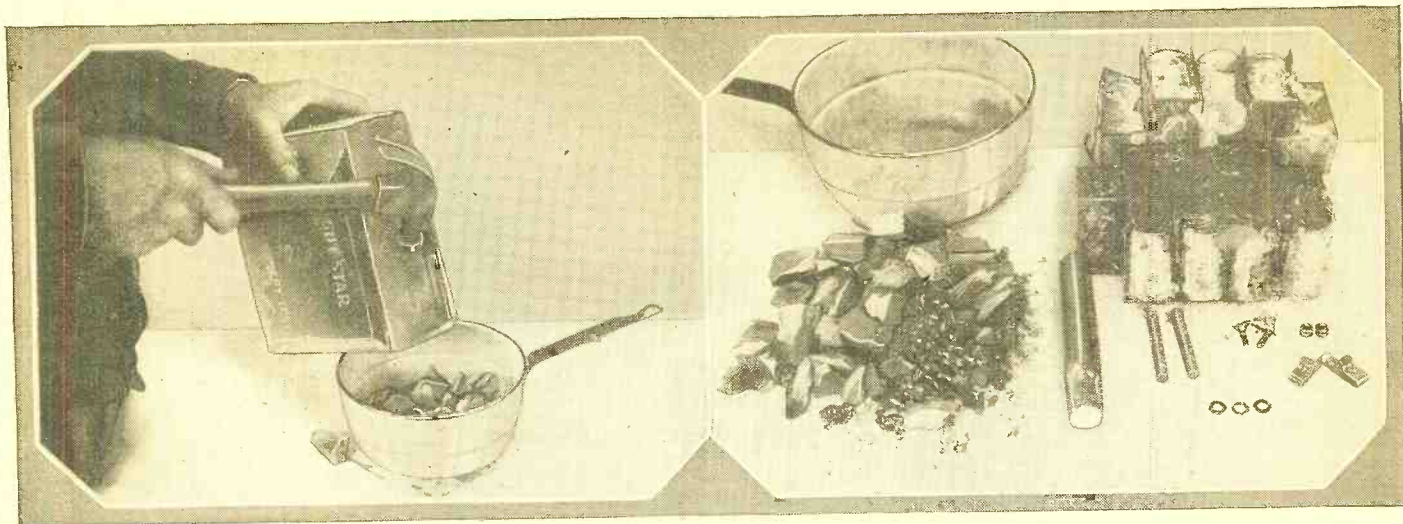

Where good "B" batteries go when they die: the resourceful constructor can use everything but the squeal—or perhaps the label.

Making Good Use of "B"-Battery By-Products

By L. B. Robbins

WHAT radio fan has not, at some time or other, wept crocodile tears over the remains of his erstwhile valuable, but now defunct, "B" batteries? No; all is not lost just because they will not operate the receiver. There is still value of a sort, and the owner will undoubtedly be surprised at what can be reclaimed from a dead battery.

In order of the processes of extracting these by-products, let's see just what they are. First comes the sealing compound, covering the block of cells and sometimes completely filling the spaces between them. Ordinarily this is nothing more than common sealing wax and it can very easily be reclaimed and poured into handy sticks for desk or shop use.

Hold the battery in one hand and knock off the top wax with a hammer into a suitable pan. Never mind if the paper and other debris comes with it. When the pan

is comfortably filled heat the wax over a slow flame until it assumes liquid form. In the meantime, roll up two or three hollow cylinders of sheet tin about a foot long and an inch in diameter. Stick these upright in holes in a board as shown in the sketch. Then pour the wax into the cylinders and allow them to cool. Unroll them and you will have as good sealing wax as ever came out of a store. If black pitch is used instead of sealing wax between the cells, that can also be melted when wanted and used to seal up other electrical apparatus. It can even be run into the cracks of leaky wooden sinks or tubs to render them watertight.

Each battery contains two or more binding posts that should be salvaged. If they are of the screw-post variety, each will consist of three parts; the screw, the nut and a washer. These can be used for panel binding posts as shown and, for the experi-

mental set builder, will save quite a bit of money in the long run.

If the posts are of the Fahnestock clip variety they will also come in very handy. Break them off at the soldered connection and flatten out the long shank with a hammer. Then drill a hole in this shank and you will have handy connectors that can be quickly attached to either panel or base-board. In either case be sure to scrape off the varnish or lacquer with which they are coated, in order to get a good metallic connection.

Inside of each cell will be found a carbon stick about 2½ inches long. These can be used for various resistance purposes by the experimenter and can be inserted in a mounting made of two of the spring clips as shown. Another excellent and novel use for such carbons is the making of a water heater. Simply drill two holes in a strip

(Continued on page 772)

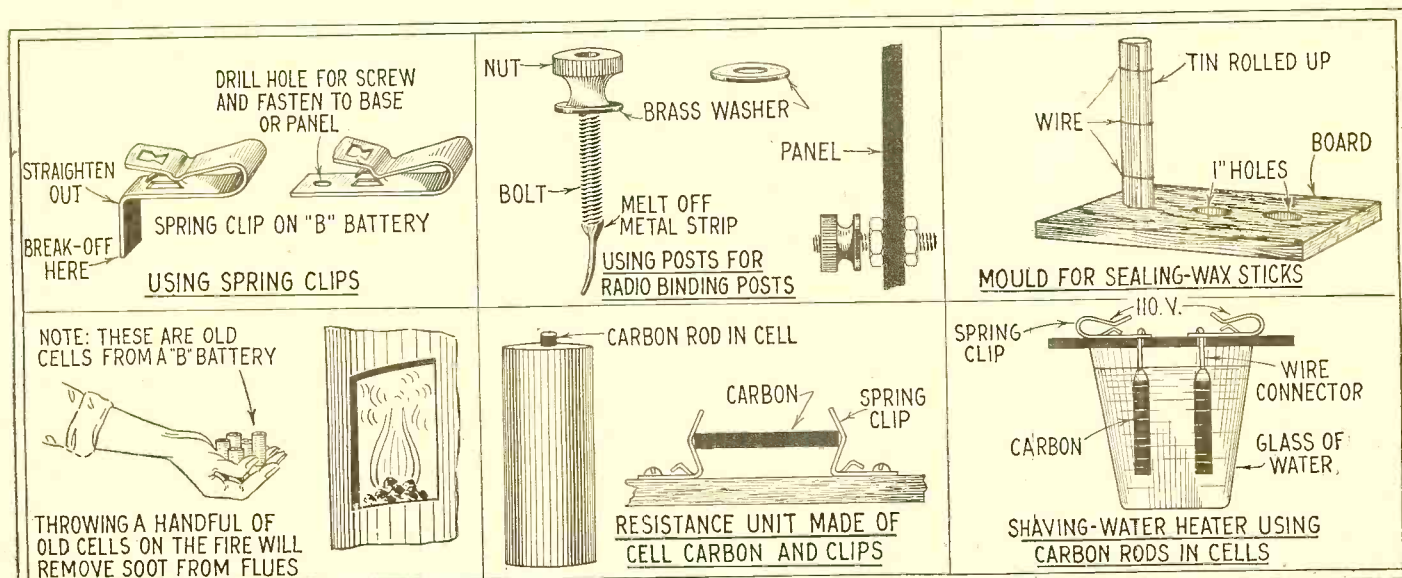

The spring clips and binding posts of batteries are useful on every experimenter's table; wax in handy form will be always handy as a fastener and an insulator, and the fumes of oxidized zinc dislodge

soot by their weight. The carbon resistors may find employment as shown, due care against short-circuits being taken; always turn off the current before removing the rods from the glass of water.



On the Short Waves



"OLD FAITHFUL" OF THE SHORT WAVES

Short-wave broadcasting, though a novelty to most of the general radio public as yet, is nevertheless practically as old as broadcasting on the present "regular" band which centers somewhere below 360 meters. As with the latter, station KDKA (whose transmitters at East Pittsburgh, Pa., are illustrated on these pages) was the pioneer and still a leader.

In the spring of 1922, only a few months after KDKA had commenced systematic broadcasting to the public on a longer wave, H. P. Davis, vice-president of the Westinghouse Electric & Mfg. Co., the owner of the station, conceived the idea of using radio relays to link together stations for simultaneous broadcasts. Dr. Frank Conrad, the technical authority to whom has been entrusted the direction of the necessary engineering development, was convinced at once that the short waves (then dismissed contemptuously to the realm of amusement, rather than experiment) would offer the solution. An experimental short-wave station, KDPM, was put in operation at Cleveland to work with KDKA, and in the following year at Hastings, Neb. KFKX undertook a regular schedule of re-broadcasting KDKA's nightly program as transmitted and received on short waves.

It was not long before the success obtained warranted an attempt to relay a program for international broadcasting; this was accomplished on Dec. 31, 1923, when a New Year's Eve program was transmitted by KDKA and successfully re-broadcast at Manchester, England. On Dec. 12, 1924, the regular short-wave program was picked up and re-broadcast at Johannesburg, South Africa, at a distance of nearly nine thousand miles; and in the following month KDKA was received and re-broadcast in Melbourne, Australia; thus spanning the diameter of the world. Each of these feats set a record in international radio telephone work.

Into the White Wastes

Since 1923 the short-wave transmitter of KDKA has been engaged in a work which exceeds in human

RADIO NEWS will welcome any definite information from our readers about unlisted stations which you may hear putting on programs, only if you hear the call or the announcement of location. Please give the wavelength as closely as you can estimate it. Because of the number of experimental transmissions by amateurs and others, we cannot undertake to list such stations in the short-wave broadcast list on another page, unless confirmation is received of their having a regular schedule; but all definite information received will be published here. Please consult data we have published before writing for information; we have no way to identify a station by its program or language, since many foreign stations transmit in several languages; nor even by its approximate wavelength, unless it is one of the larger and best-known transmitters.

interest, undoubtedly, its many scientific and engineering achievements—that of keeping in touch with civilization its pioneers in the frozen Arctic. It began with the distribution by the Canadian Westinghouse Co. of receivers to the Royal Canadian Mounted Police; now traders, explorers, missionaries, and others rely upon the messages thus sent to them for news and entertainment, especially in the midday night of the northern winter. In fact, many lives have been saved through the directions sent out from this station for the organization of relief expeditions at posts capable of aiding isolated parties whose plight would not otherwise have been known in time. At present KDKA is transmitting also "Far South" programs for the benefit of Commander Byrd's expedition; these transmissions represent a most carefully prepared series of distance programs. To reinforce the service of KDKA, the Westinghouse stations WBZ,

Springfield, Mass., and KYW, Chicago, are also equipped with short-wave equipment which is kept ready for use.

In addition to regular programs of music and speech, and the special messages which have been from time to time sent out to individuals in the Arctic regions, as above described, the short-wave transmitters at East Pittsburgh have been used for motion-picture and radio-photo broadcasts: some of this work was illustrated and explained in the November 1928 issue of RADIO NEWS (page 416). As yet no attempt has been made to present television on a regular schedule from this station; and it is stated by the company that it has no intention of doing so until the system has been developed to a point of greater efficiency, comparable with that of audible broadcasting. In the meantime, of course, experiments may be expected to continue, and will be of interest to amateurs.

Recently great success has been shown in the broadcast of radio pictures by the Zworykin system; by this a photograph five inches by eight may be reproduced at the receiving end in less than one minute. The reproduction is an actual photograph; being made on regular sensitized paper by the action of light. The receiver must be synchronized to the transmitter by a special device operated by a constant-frequency signal with which the carrier of the image-frequency is simultaneously impressed. This apparatus was demonstrated at the Radio World's Fair in New York recently; we have not, however, any constructional data of the apparatus, which must be constructed with much precision to duplicate such results as have been obtained in the demonstrations.

The transmitters illustrated on these pages operate on 62.50 and 25.40 meters; ultra-short telephone work is no longer carried on with any degree of regularity. It is stated that these wavelengths have been determined to be quite satisfactory for the purpose of long-distance work; and it is not the desire of the technical staff to alter them, unless the progress of television research shall show others to be better fitted for that special purpose.

SUGGESTS ESPERANTO

Editor, RADIO NEWS:

As you will certainly know, atmospheric conditions are very bad here on the broadcast waves, thus leaving us the short waves as our only hope. Lately I have been very idle, but it might interest you to hear that W2XAF and KDKA come in regularly, signal strength being very good on a carefully designed two-tube. It is a pity that we have to be up so late in the night (or early in the morning!) to get your short-wave broadcasts (*The compliment is returned!*—EDITOR.), but it is hoped that sooner or later you will follow PCJJ's policy of addressing special programs to different countries. This would undoubtedly bring us closer together and do a lot for your radio market. Another point I should mention is the linguistic problem. (*Ouch!*) Now that anyone possessing a single tube short-wave receiver can pick up stations from all over the world, there is no reason why a language common to all should not be used for international broadcasting. Why not broadcast in Esperanto at least once a week?

TELESFORO JOSE GORDINHO,
Radio-Polano, Lourenco Marques,
Portuguese East Africa.

(*Sr. Gordinho asks a question which has been on the lips of many before him. The problem is entirely too much for us to attempt an answer. We might say, however, that Esperanto has been attempted with discouraging results in this country, at least, though it is still in use elsewhere. Our own WRNY tried it for a season in 1925-26 and gave up.*)

COSTA RICA'S BROADCASTER SPEAKS

Editor, RADIO NEWS:

I am most thankful for your publication of Mr. Charles Schroeder's letter in your monthly, and I am inclosing herewith the whole story of such wonderful and unusual reception as that experienced by the Philadelphia fan. I have been transmitting ever since the first of last May, using during that month a 38-meter wave; at that time I was reported by many as being interfered with, and so lowered my wave to 30 meters. Since that change in June

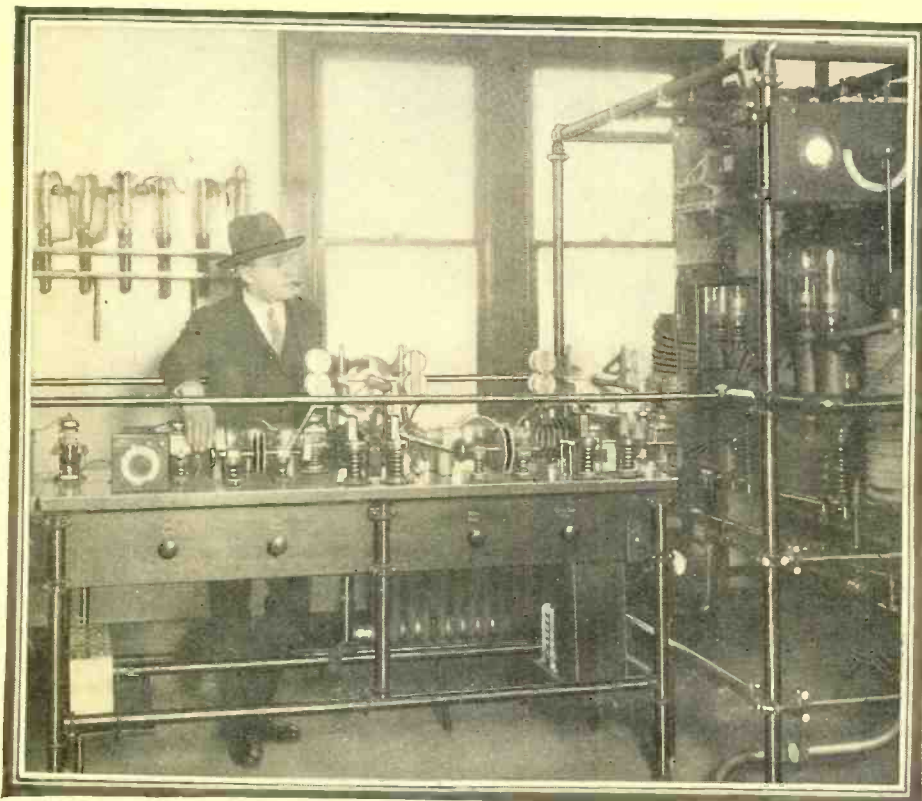

One of the short-wave transmitters at KDKA. C. W. Horn, superintendent of radio operations for the Westinghouse company, is making adjustments on one of the early R.F. amplifying stages.

I have had reports from points within a 3000-mile radius around this city: Chile, Peru, Ecuador, Colombia, Venezuela, West Indies, Nicaragua, Salvador, Honduras, Guatemala, Mexico, Cuba, and Tampa, Florida; but now your magazine establishes my DX at Philadelphia—a distance of 2,500 miles and this on a 7½-watt tube. (A 210-type).

I am on the air regularly every evening, 9:30 to 10:30 Central Standard Time, using a 30.3-meter wave. I use a 7½-watt oscillator but expect to change this for a 75- or 150-watt tube pretty soon. My calls are NRH and NR4AC. Please include these in your list of short-wave stations of the world.

AMANDO CESPEDES MARIN,
Heredia, Costa Rica, Central America.
(Sr. Cespedes' call has been listed in our short-wave tables, starting with the January issue.)

stay up that late to make a speech. (Perhaps Melbourne, Australia, with a call beginning 3A). I also hear a number of station harmonics such as WAAM on 24.5 meters and Toronto on 70. I have been reading RADIO NEWS since 1921.

ARTHUR J. GREEN,
700 Alpha Street, Klondyke, Ohio.

I have heard Hiroshima, Japan, at about 33 meters, on Friday evenings at about 9 p. m. (EST). His signal is so weak that I cannot make out the call letters.

I would like to communicate with short-wave enthusiasts in my locality, and also any in foreign countries. The only fault I can find with RADIO NEWS is that the short-wave section is so small.

JAMES IZATT,
2616 Forest Street, McKeesport, Penna.

at their best, very loud and steady, with no swinging; 3LO, Melbourne on 32 meters has plenty of wallop; 2ME, Sydney, on 28.50 and especially 6AG, Perth, on 32.90 come in very loud. These, with 2BL, Sydney, 32.50 and 2FC, Sydney, 28.50 are doing a lot of experimenting. After 7:00 a. m. (EST) 3LO is on a chain program with 5CL, Adelaide, announced jointly. Perth announces "Hello, hello! This is 6AG, Perth, in Western Australia." (This is the farthest station in the world, from the Eastern United States.) He is 9,000 miles from San Pedro, yet I believe his wallop and wavelength will cover all U. S. A. (Not necessarily; this is the first report we have received.)

ANE, Bandoeng, Java will be found on 31.86 and 33 meters, also on 15.93 and sometimes other waves. The Japanese station JOAK on 30, 35, 60 and 70 meters uses a different one each morning; the lowest are his best waves. JHBB on 37.50 is at Iharikiken, Hirasio, Japan.

My set uses Karas parts, wired for 112A Radiotrons; Exide wet batteries for both "A" and "B." My aerial is a single-strand of No. 12 enamelled wire, 84 feet high, 100 feet long, pointing east. The aerial is very taut, and is led direct to the set through the center of a plate-glass window. The ground is made of large copper plates, buried sixteen feet deep in water-bearing ground. My short-wave set was built by Mrs. C. S. Pugh, a radio operator of Melbourne, Australia; the parts cost me \$43.10 and I have been getting more thrills and pleasure out of it than out of my 10-tube broadcast set; I receive all stations without static. What is more, I am having a four-tube short-waver made to use the screen-grid tube.

But now is the time to receive Australia, between 4:30 a. m. and 8:30 a. m. (EST); while the Russian RFM on 70 meters at Khabarovsk comes in like a local all the time. He says he uses ten kilowatts, but I really believe he is pumping in fifty.

DONALD F. WRIGHT,
1123 South Meyler St., San Pedro, Calif.

(Even with the elaborate and efficient antenna system described, the results obtained seem remarkable; the location is probably favored. Many, of course, would be unable to make such a record with any equipment; but, as the rooster said when he showed his wives an ostrich egg, "This is not a criticism, but only to let you see what can be done.")

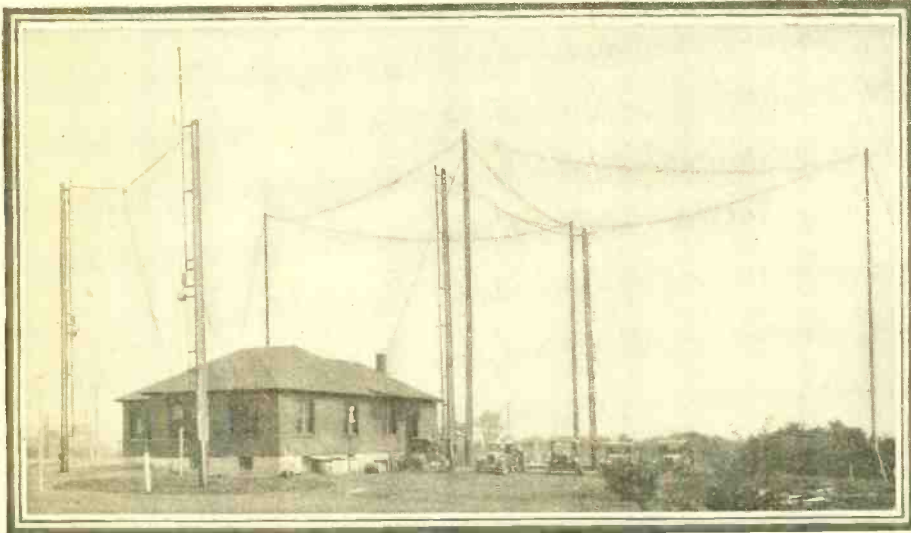

From this modest building at East Pittsburgh, Pennsylvania, went the first radio program heard around the world. The antennas of the short-wave transmitters are at the left.

SHORT-WAVE STATIONS HEARD

So many of our readers have heard what are obviously telephone tests on the short waves, and have written in to ask for verifications, that we must point out that these are not broadcasts, but in the nature of private communications. While it is impossible, with ordinary radiophone work, to prevent listeners who are tuned in from hearing the speech, the commercial companies which are conducting this work do not give out any information on the subject—which is, of course, none of the public's business, so long as the tests are conducted in commercial channels. Radio listeners are forbidden by the Radio Act of 1927 from making public or otherwise using anything which they may hear, either in voice or phone transmission, other than broadcasts and other matter obviously intended by its nature to be for everybody.

Editor, RADIO NEWS:

About a month ago I made a short-wave receiver somewhat like the "Junk-Box" using three-plate condensers in place of midgets, a .0001 grid condenser and two stages of audio. I also put a second aerial on the plate coil (Why?) and have heard about forty stations below eighty meters. Chelmsford (SSW) is a regular and I often get them loud enough to be heard through the eight-room house; PCJJ I have heard five times, twice on loud speaker. I hear them on Thursdays, at about 7:30 to 10 (EST) broadcasting special American programs. I also heard Sydney, Australia, "closing down."

I heard several others I could not identify; one on 25 meters called "Hello, New York" and New York answered (transatlantic phone—see note above.) Another on 18 meters or so was calling in a foreign tongue; and another on 38 meters spoke the most unintelligible tongue I have ever heard (Japanese? Or Russian?)

I especially wish to identify a Spanish-speaking station I heard on about 26 meters Nov. 3, from 11:30 to midnight, playing records. Another was heard on about 33 meters Nov. 23 at 4 a. m. A member of the department of agriculture was followed by some Columbia records and a talk on short-wave receivers and reception. They said they had been heard around the world. The call letters began with CA or ZA; but I don't think it is a Canadian station, for I don't think a member of the department of agriculture would

GOOD LOCATION, WHAT?

Editor, RADIO NEWS:

I am forwarding photo of verifications of reception of a few foreign stations on short waves (SSW, RFM, JOAK, 3LO, 2FC, PCLL). I have no trouble receiving 5SW or PCLL; I can play the former with good tone on a 9-inch Peerless speaker with three-foot baffle board.

Right now Australian stations are coming in

GOOD WORK ON FOREIGNERS

Editor, RADIO NEWS:

I wish to report the following as received by me, using a screen-grid two-tube set which I have remodeled. A three-plate tuning condenser requires seven coils between 15 and 80 meters, but

(Continued on page 784)

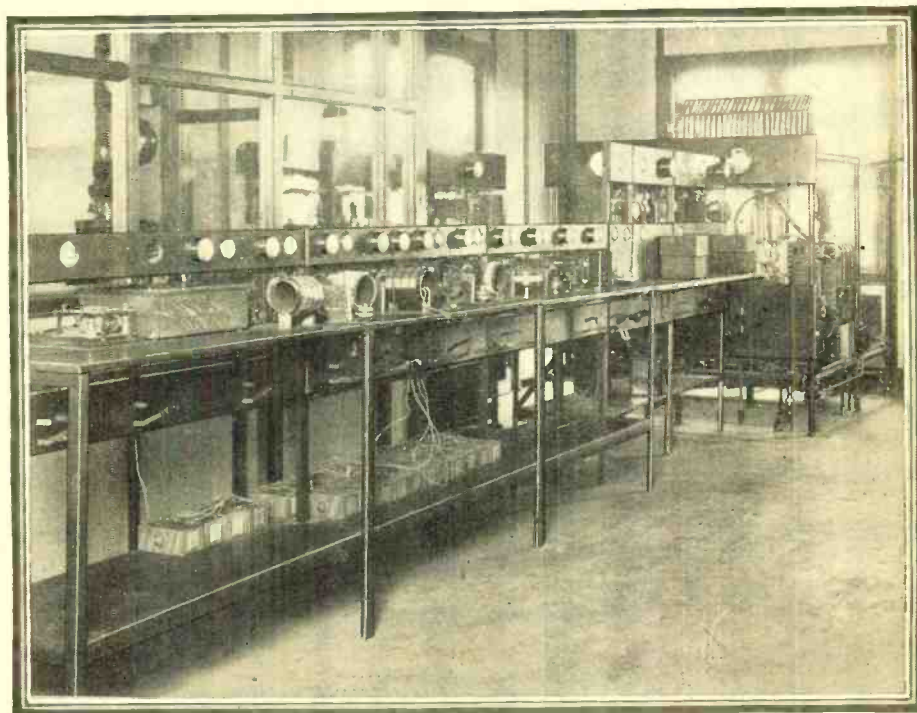

The short-wave transmitters of KDKA are housed in the same building with the long-wave sender. Above is shown some of the short-wave equipment, with a transmitter at the rear.

New List of Broadcast Stations in the United States

Radio Call Letters	BROADCAST STA. Location	Wave (Meters)	Power (Watts)	Radio Call Letters	BROADCAST STA. Location	Wave (Meters)	Power (Watts)	Radio Call Letters	BROADCAST STA. Location	Wave (Meters)	Power (Watts)	Radio Call Letters	BROADCAST STA. Location	Wave (Meters)	Power (Watts)
KDKA	East Pittsburgh, Pa.	306	25000	KGTT	San Francisco, Calif.	211	500	WBAB	Harrisburg, Pa. (day)	210	500	WGM5	See WLB		
KDLR	Dallas, Tex.	248	100	KGTU	Honolulu, Hawaii	319	500	WBAL	Baltimore, Md.	275	5000	WGN	Chicago, Ill.	416	25000
KDYR	Salt Lake City, Utah	232	1000	KCWB	Portland, Oregon	484	1000	WBAP	Fort Worth, Texas	283	10000	WGR	Atlanta, Ga.	545	1000
KEJL	Los Angeles, Calif.	282	1000	KHJ	Lacey, Washington	250	10	WBAB	Nashville, Tenn.	201	5000	WGST	Schenectady, N. Y.	337	250
KELW	Burbank, Calif.	384	500	KHJ	Los Angeles, Calif.	333	1000	WBAB	Wilkes-Barre, Pa.	248	100	WGY	(Time limited)		
KEX	Portland, Oregon	264	5000	KHJ	Spokane, Wash.	303	1000	WBBC	Brooklyn, N. Y. City	214	250	WHA	Madison, Wis.	526	5000
KFAB	Lincoln, Nebraska	389	5000	KICK	Red Oak, Iowa	211	100	WBBC	Richmond, Va.	219	100	WHAD	Milwaukee, Wis. (day)	263	250
KFAD	Phoenix, Arizona	484	500	KIDO	Boise, Idaho	240	1000	WBBC	Chicago, Ill.	231	1000	WHAM	Rochester, N. Y.	261	5000
KFBK	Havre, Montana	220	250	KJBS	San Francisco, Calif. (day)	273	100	WBBC	Rossville, N. Y. City	389	25000	WHBF	New York City	231	1000
KFBL	Everett, Washington	219	50	KKR	Seattle, Wash.	309	5000	WBBC	Norfolk, Va.	250	100	WHAS	Louisville, Ky.	365	5000
KFBO	Laramie, Wyoming	500	500	KKCP	Blytheville, Ark. (day)	232	50	WBBC	Charleston, S. C.	250	75	WHB	Troy, N. Y.	316	500
KFCB	Phoenix, Arizona	229	100	KKLN	Independence, Mo. (Ltd)	316	50	WBBC	Ponca City, Okla.	250	100	WHBC	Kansas City, Mo.	316	500
KFCR	Santa Barbara, Calif.	200	100	KLRA	Little Rock, Ark.	216	1000	WBBC	Boston, Mass.	220	500	WHBD	Canton, Ohio	250	10
KFCU	Beaumont, Texas	535	500	KLS	Oakland, Calif. (day)	208	250	WBBC	Detroit, Mich.	229	100	WHBL	Rock Island, Ill.	248	100
KFDJ	Shreveport, Louisiana	239	100	KLX	Oakland, Calif.	341	500	WBBC	Union City, N. J.	207	250	WHBP	Johnstown, Pa.	213	500
KFDY	Brookings, S. D.	545	100	KMZ	Denver, Colo.	535	1000	WBBC	New York City, N. J.	222	250	WHBQ	Memphis, Tenn.	219	100
KFEC	Portland, Oregon	219	100	KMA	Shenandoah, Iowa	322	500	WBBC	See WABC			WHBU	Anderson, Indiana	248	100
KFEL	Denver, Colorado	319	250	KMBC	Medford, Oregon	211	50	WBBC	See WABC			WHBV	Philadelphia, Pa.	200	100
KFEQ	St. Joseph, Mo. (day)	535	100	KMED	Inglewood, Calif.	268	500	WBBC	Birmingham, Ala.	229	100	WHBY	West De Pere, Wis.	250	100
KFEG	Kellogg, Idaho	248	100	KMIC	Fresno, Calif.	250	100	WBBC	Wilkes-Barre, Pa.	248	100	WHDF	Minneapolis, Minn.	216	500
KFGQ	Boonville, Mo.	259	100	KMJO	Clay Center, Neb. (day)	405	1000	WBBC	Tilton, N. H.	210	500	WHDI	Chicago, Ill.	229	100
KFH	Wichita, Kansas	251	1000	KMJJ	Tacoma, Wash.	224	250	WBBC	Wellesley Hills, Mass. (Time limited)	384	100	WHFC	Cleveland, Ohio	216	1000
KFHA	Gunnison, Colorado	250	50	KMKT	St. Louis, Mo.	224	1000	WBBC	See WABC			WHFD	New York City	297	250
KFIF	Portland, Oregon	211	50	KMTR	Hollywood, Calif.	526	1000	WBBC	See WABC			WHFH	Des Moines, Iowa	300	5000
KFIO	Spokane, Wash. (day)	244	100	KNRX	Santa Monica, Calif.	384	500	WBBC	See WABC			WHFI	New York City	219	1000
KFIU	Jutaca, Alaska	259	10	KNXX	Los Angeles, Calif.	286	5000	WBBC	See WABC			WHFJ	Chicago, Ill.	203	5000
KFIZ	Fond du Lac, Wis.	211	100	KOA	Denver, Colo.	361	12500	WBBC	See WABC			WHFG	Philadelphia, Pa.	200	100
KFJB	Marshalltown, Iowa	250	100	KOAC	Corvallis, Oregon	535	1000	WBBC	See WABC			WHFH	St. Louis, Mo.	211	100
KFJF	Oklahoma City, Okla.	204	5000	KOBC	State College, N. Mex.	234	10000	WBBC	See WABC			WHFI	Chicago, Ill.	203	5000
KFJI	Astoria, Oregon	219	50	KOCW	Chickasha, Okla.	219	100	WBBC	See WABC			WHFJ	New York City	219	1000
KFJM	Grand Forks, N. D.	545	500	KOH	Reno, Nevada	219	100	WBBC	See WABC			WHFK	Chicago, Ill.	219	100
KFJN	Portland, Oregon	239	500	KOIL	Council Bluffs, Iowa	238	1000	WBBC	See WABC			WHFL	Madison, Wis.	248	100
KFJZ	Port Dodge, Iowa	229	100	KOIN	Portland, Oregon	319	1000	WBBC	See WABC			WHFM	Elkins Park, Pa. (Sun.)	322	50
KFKA	Fort Worth, Texas	219	100	KOL	Sylvan, Ore.	236	1000	WBBC	See WABC			WHFN	Jackson, Mich.	219	100
KFKB	Greely, Colorado	341	500	KOMO	Seattle, Wash.	326	1000	WBBC	See WABC			WHFO	Chicago, Ill.	526	5000
KFKC	Milford, Kansas (day)	265	5000	KOOS	Marshfield, Oregon	19	50	WBBC	See WABC			WHFP	Ottumwa, Iowa (day)	211	100
KFKU	Lawrence, Kansas	246	100	KORE	Eugene, Oregon	211	100	WBBC	See WABC			WHFQ	Madison, Wis.	248	100
KFKV	Chicago, Illinois	294	5000	KOW	Denver, Colo.	216	500	WBBC	See WABC			WHFR	Elkins Park, Pa. (Sun.)	322	50
KFKW	Kirkville, Missouri	250	50	KPCB	Seattle, Wash.	248	100	WBBC	See WABC			WHFS	St. Louis, Mo.	211	100
KFLV	Rockford, Illinois	213	500	KPCB	Prescott, Arizona	200	100	WBBC	See WABC			WHFT	Chicago, Ill.	219	100
KFLX	Galveston, Texas	219	100					WBBC	See WABC			WHFU	St. Louis, Mo.	211	100
KFMX	Northfield, Minn.	240	1000					WBBC	See WABC			WHFV	St. Louis, Mo.	211	100
KFNF	Shenandoah, Iowa	337	500					WBBC	See WABC			WHFW	St. Louis, Mo.	211	100
KFNG	Long Beach, Calif.	240	1000					WBBC	See WABC			WHFX	St. Louis, Mo.	211	100
KFNL	Lincoln, Nebraska	242	1000					WBBC	See WABC			WHFY	St. Louis, Mo.	211	100
KFNR	Dublin, Texas	229	15					WBBC	See WABC			WHFZ	St. Louis, Mo.	211	100
KFPM	Greenville, Texas	229	15					WBBC	See WABC			WHGA	St. Louis, Mo.	211	100
KFPW	Siloam Springs, Ark. (day)	224	50					WBBC	See WABC			WHGB	St. Louis, Mo.	211	100
KFPY	Spokane, Wash.	216	500					WBBC	See WABC			WHGC	St. Louis, Mo.	211	100
KFQB	Port Worth, Texas	242	1000					WBBC	See WABC			WHGD	St. Louis, Mo.	211	100
KFQD	Anchorage, Alaska	244	100					WBBC	See WABC			WHGE	St. Louis, Mo.	211	100
KFQU	Holy City, Calif.	211	100					WBBC	See WABC			WHGF	St. Louis, Mo.	211	100
KFQW	Seattle, Wash.	211	100					WBBC	See WABC			WHGG	St. Louis, Mo.	211	100
KFQZ	Hollywood, Cal. (Ltd)	353	1000					WBBC	See WABC			WHGH	St. Louis, Mo.	211	100
KFRG	San Francisco, Calif.	492	1000					WBBC	See WABC			WHGI	St. Louis, Mo.	211	100
KFRU	Columbia, Missouri	476	500					WBBC	See WABC			WHGJ	St. Louis, Mo.	211	100
KFSD	San Diego, Calif.	329	500					WBBC	See WABC			WHGK	St. Louis, Mo.	211	100
KFSG	Los Angeles, Calif.	268	500					WBBC	See WABC			WHGL	St. Louis, Mo.	211	100
KFUL	Galveston, Texas	232	500					WBBC	See WABC			WHGM	St. Louis, Mo.	211	100
KFUM	Colorado Springs, Colo.	236	1000					WBBC	See WABC			WHGN	St. Louis, Mo.	211	100
KFUP	St. Louis, Mo.	545	500					WBBC	See WABC			WHGO	St. Louis, Mo.	211	100
KFUR	Denver, Colorado	229	100					WBBC	See WABC			WHGP	St. Louis, Mo.	211	100
KFV	Ogden, Utah	229	100					WBBC	See WABC						
KFVD	Yonkers, Calif. (Ltd.)	428	250					WBBC	See WABC						
KFVS	Cape Girardeau, Mo.	248	100					WBBC	See WABC						
KFWB	Los Angeles, Calif.	316	1000					WBBC	See WABC						
KFWC	San Bernardino, Calif.	250	100					WBBC	See WABC						
KFWF	St. Louis, Missouri	250	100					WBBC	See WABC						
KFWI	Portland, Oregon	329	500					WBBC	See WABC						
KFWM	Oakland, Calif.	322	500					WBBC	See WABC						
KFXD	Jerome, Idaho	211	50					WBBC	See WABC						
KFXF	Denver, Colorado	319	250					WBBC	See WABC						
KFXJ	Edgewater, Colo.	229	50					WBBC	See WABC						
KFXR	Oklahoma City, Okla.	229	50					WBBC	See WABC						
KFY	Portland, Oregon	211	100					WBBC	See WABC						
KFYX	Breckenridge, Texas	211	100					WBBC	See WABC						
KFYR	Bismarck, N. D.	545	500					WBBC	See WABC						
KGA	Spokane, Wash.	204	5000					WBBC	See WABC						
KGAR	Tucson, Arizona	219	100					WBBC	See WABC						
KGB	San Diego, Calif.	220	250					WBBC	See WABC						
KGBU	Lincoln, Nebraska	333	500					WBBC	See WABC						
KGBX	St. Joseph, Mo.	200	100					WBBC	See WABC						
KGBZ	York, Nebraska	322	500					WBBC	See WABC						
KGCA	Decorah, Iowa (day)	236	50					WBBC	See WABC						
KGCB	Oklahoma City, Okla.	219	50					WBBC	See WABC						
KGCC	San Antonio, Texas	219	100					WBBC	See WABC						
KGCD	Cedar Rapids, Iowa	211	50					WBBC	See WABC						
KGCR	Brookings, S. D.	243	100					WBBC	See WABC						
KGCU	Mandan, N. D.	250	100					WBBC	See WABC						
KGCV	Vida, Montana	211	10					WBBC	See WABC						
KGDA	Dell Rapids, S. D.	219	15					WBBC	See WABC						
KGDE	Barratt, Minn.	250	50					WBBC	See WABC						
K															

Main table listing radio call letters, broadcast station locations, wave meters, and power in watts for various stations across the United States.

LIST OF CANADIAN BROADCAST CALLS

Table listing Canadian broadcast calls, including call letters, station locations, wave meters, and power in watts.

LIST OF SHORT-WAVE STATIONS OF THE WORLD

(Some calls may have been altered under new international regulations.)

Large table listing short-wave stations of the world, categorized by continent (Africa, Australia, Austria, Belgium, Canada, Costa Rica, Dantzic, Denmark, England, Finland, France, Germany, Holland, Italy, Japan, Java, Mexico, Morocco, Norway, U.S.S.R., Spain, Sweden, Switzerland, United States) with call letters, locations, wave meters, and power.

THIS list of the short-wave broadcast stations throughout the world is not complete, although we have endeavored to list every station of whom we have heard reports; since in many cases reliable information about the programs, wavelength and power of the stations cannot even be obtained from the stations themselves. (See page 750)

(Several short waves are used for transatlantic telephony. This is private business, not broadcasting.)



Radio News Laboratories



RADIO manufacturers are invited to send to RADIO NEWS LABORATORIES samples of their products for test. It does not matter whether or not they advertise in RADIO NEWS, the RADIO NEWS LABORATORIES being an independent organization, with the improvement of radio apparatus as its aim. If, after being tested, the instruments submitted prove to be built according to modern radio engineering practice, they will each be awarded a certificate of merit; and that apparatus which embodies novel, as well as meritorious features in design and operation, will be described in this department, or in the "What's New in Radio" department, as its news value and general interest for our readers shall deserve. If the apparatus does not pass the Laboratory tests, it will be returned to the manufacturer with suggestions for improve-

ments. No "write-ups" sent by manufacturers are published in these pages, and only apparatus which has been tested in the Laboratories and found of good mechanical and electrical construction is given a certificate. As the service of the RADIO NEWS LABORATORIES is free to all manufacturers, whether they are advertisers or not, it is necessary that all goods to be tested be forwarded prepaid, otherwise they cannot be accepted. Apparatus ready for, or already on, the market will be tested for manufacturers free of charge. Apparatus in process of development will be tested at a charge of \$2.00 per hour required to do the work. Address all communications and all parcels to RADIO NEWS LABORATORIES, 230 Fifth Avenue, New York City. Readers will be informed on request if any article has been issued a Certificate of Merit.

A.C. SET PROTECTOR

The A.C. line-voltage reducer ("Type 507-109" submitted by the Ward Leonard Electric Company, Mount Vernon, N. Y., consists of a vitreous-enameled resistor of the 75-watt type, contained in a perforated metal housing provided at one end with prongs for insertion into a line receptacle, and at the other with a socket for the insertion of the usual extension cord. The resistance element, when used at ordinary load, was found to have a value of 27 ohms; this is in series with one side of the line, the other side of which has a direct connection through the device. The length over-all is 3 3/4 inches and the diameter 1 5/8 inches.

AWARDED THE RADIO NEWS LABORATORIES CERTIFICATE OF MERIT NO. 2486.

A.C. RADIO RECEIVER

The "Model 28" 7-tube A.C. radio receiver submitted by the American Bosch Magneto Corp., Springfield, Mass., was found on test to be very sensitive with ample selectivity. Three shielded R.F. stages using the 226-type tubes, are followed by the conventional 227-type detector; the audio amplifier has one 226-type tube, followed by push-pull power (17A) amplification. A full-wave rectifier of the 280-type delivers well-filtered "B" current to the tubes; and the winding of the power transformer is provided with 1 1/2-, 2 1/2-, and 5-volt windings for the filaments. The receiver has a single tuning control, with drum dial operated by a knob directly under the scale window. A variometer trimmer, used for antenna compensation, is controlled by the knob at the left of the escutcheon; the volume-control comprises a pulley wheel belted to a smoothly-operating variable resistor on the right end of the



chassis. The power switch, above the escutcheon plate, operates directly on the house-line; cord-tip jacks are provided for the speaker cord, and 10-foot extension cords for both aerial and ground. The cabinet is of mahogany finish, 23 1/2 inches long, 10 1/2 inches deep, and 10 inches high.

AWARDED THE RADIO NEWS LABORATORIES CERTIFICATE OF MERIT NO. 2487.

CONE SPEAKER

The loud-speaker submitted by the same manufacturer is a mantel-type Gothic design. A powerful balanced-armature unit is used with an 8-inch cone, corrugated to promote clearer reproduction; the support of both is a die-stamped metal housing of heavy material. The cabinet is 10 1/2 inches long, 12 inches high and 6 1/2 inches deep, with front and back screened and grilled for the passage of the sound waves; the construction creates a baffle for the lower notes.

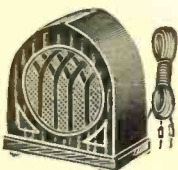

Faithful quality with ample volume over the entire audio-frequency band is obtained.

AWARDED THE RADIO NEWS LABORATORIES CERTIFICATE OF MERIT NO. 2488.

VACUUM-TUBES

The "Type 426" A.C.-filament vacuum tube submitted by the De Forest Radio Company, Central Ave., and Franklin St., Jersey City, N. J., requires 1.05 amperes at approximately 1.5 volts for normal operation. Its dynamic characteristics are, amplification constant 8.2; plate impedance at 135 volts 7,400 ohms; and its mutual conductance as measured approximately 1,100 micromhos. The tube was found to function satisfactorily as either radio-frequency or audio-frequency amplifier.

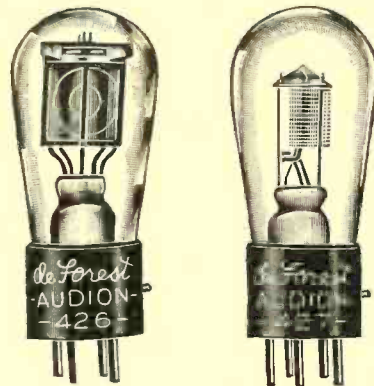

The "Type 427" A.C. tube of the same manufacture is of indirect-heated-cathode design, especially for use as a detector. It requires 1.75 amperes at 2.5 volts for the heater; its dynamic characteristics are, voltage amplification 8.2; plate impedance at 90 volts 11,300 ohms, and mutual conductance 320 micromhos.

The "Type 471" of the same manufacture is a power amplifier; its "A"-type filament requires for normal operation 1/4-ampere at 5 volts. It has an amplification constant of 3; its plate impedance is

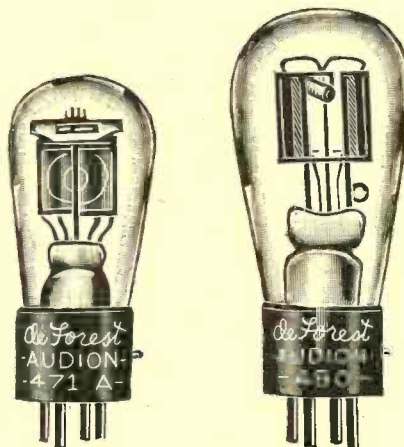

2,000 ohms at 180 volts, and its mutual conductance 1,500 micromhos.

The "Type 480" rectifier tube of the same manufacture is of the full-wave type, designed for use in "B" power-supply units operating from A.C. house-lighting circuit, and has a maximum output of 125 milliamperes (both plates), at a maximum rated A.C. plate-voltage supply of 300 (per plate). This tube is provided with the standard UX molded-bakelite base.

AWARDED THE RADIO NEWS LABORATORIES CERTIFICATES OF MERIT NOS. 2489, 2490, 2491, 2492, respectively.

TEST EQUIPMENT

The "Universal" A.C. tube-and-set tester ("No. R-512"), manufactured by the Sterling Manufacturing Co., 2831 Prospect Ave., Cleveland, Ohio, comprises a metallic housing of green crystalline finish, which contains the necessary switches, resistors, "C" batteries, meters and the necessary adapters; the meters are of the moving-vane type, and were found sufficiently accurate for all purposes. By its use, defects in apparatus, open circuits, poorly-soldered joints, etc., may be detected, plate current of A.C. tubes may be determined. In operation, the 5-prong plug is inserted into the tube socket of the stage under test; it is adapted to 4-prong sockets by one of the adapters supplied. The housing is 7 inches long, 5 1/2 inches wide, and 2 1/2 inches deep, over-all.

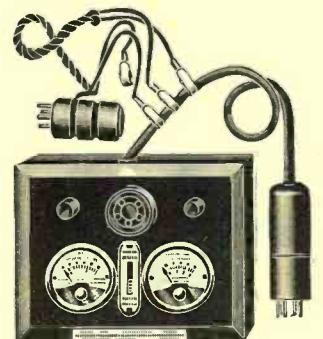

AWARDED THE RADIO NEWS LABORATORIES CERTIFICATE OF MERIT NO. 2493.

SET PROTECTOR

The line-voltage control manufactured by the Master Engineering Co., 122 South Michigan Ave., Chicago, Ill., has four connecting positions, for input voltage of 110-115, 115-120, 120-125, and 125 or over, respectively; these place resistors in series with one side of the A.C. line. When measured under load, the 110-115-volt adjustment gives one ohm resistance; the 115-120, 17 ohms; the 120-125, 32 ohms; and the last 46 ohms. The wire resistor elements are enclosed within a small rectangular metallic box, 3 inches long, 1 1/4 inches square. At one end prongs are provided for the lighting receptacle; while on one side a bakelite strip has been die-punched for the various voltage positions, into one of which the extension cord of the radio receiver is inserted. The device was



found to handle 75 watts without excessive heating. AWARDED THE RADIO NEWS LABORATORIES CERTIFICATE OF MERIT NO. 2494.

LEAD-IN CLAMP

The aerial lead-in clamp manufactured by the F-G Manufacturing Co., Indianapolis, Indiana, is so designed that it may be fixed to a parapet, eave corner, gutter, window sill, or any other point where it is desirable to keep the lead-in from contact with a building. The maximum grip of the clamp is approximately 10½ inches, and its least 4½ inches. It is provided with two insulators, (one attached to the rod adjusting the sliding jaw), placed so that the lead-in will at all times be at least 6 inches from the walls; the extended length is approximately 28 inches, and the width over-all is 12½ inches.

AWARDED THE RADIO NEWS LABORATORIES CERTIFICATE OF MERIT NO. 2495.

FIXED RESISTOR

The "Eminent" screw-type resistor submitted by Paul Zollner, Konumandanstr, 51, Berlin S14, Germany, is similar to that described last month as receiving Certificate of Merit No. 2451, but is supplied with screw terminals and thumb nuts; assembled, it is 1½ inches long, and ¼-inch in diameter.

AWARDED THE RADIO NEWS LABORATORIES CERTIFICATE OF MERIT NO. 2496.

LIGHTNING ARRESTER

The "Gapless" radio lightning arrester manufactured by the Amoroso Manufacturing Co., 60 India



Street, Boston, Mass., has a porcelain housing 4½ inches long, 1¼ inches wide and 1¾ inches high, containing two metallic plates separated by a high resistor. The arrester permits charges induced on the aerial by atmospheric conditions to leak to ground, without impairing R.F. signals and consequent reproduction.

AWARDED THE RADIO NEWS LABORATORIES CERTIFICATE OF MERIT NO. 2497.

POWER TRANSFORMER AND CHOKE

The "Type 387" "B" power transformer submitted by the Pilot Elec. Mfg. Co., 323 Berry St., Brooklyn, N. Y., is designed for operation on a 110-volt 60-cycle circuit and may be used in connection with either gaseous or the filament-type rectifier tubes. It is provided with two center-tapped secondary windings, one of which will supply 275 volts at 60 milliamperes; either half of the 5-volt center-tapped winding at load will deliver two amperes. The latter winding is used for the filament of a rectifier tube, or for the power tube in the radio receiver when a gaseous-type rectifier is employed. The transformer is 3¾ inches high, 2¾ inches wide and 3½ inches deep over-all; it is provided with a 6-foot extension cord.

AWARDED THE RADIO NEWS LABORATORIES CERTIFICATE OF MERIT NO. 2498.

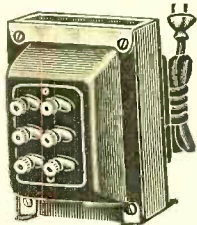

No. 2498

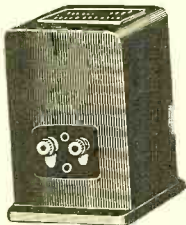

No. 2499

A filter-choke coil of the same manufacture is designed for use in connection with the "387" transformer; its measured inductance is approximately 30 henries, under a load of 60 milliamperes. It is enclosed in a black enameled housing 3¾ inches high and 2½ inches square.

AWARDED THE RADIO NEWS LABORATORIES CERTIFICATE OF MERIT NO. 2499.

The "Type 397" voltage divider manufactured by the same concern has been designed for use in connection with their "387" transformer and two of the

filter chokes described above; it consists of four wire-wound sections of 4,000, 3,650, 2,250 and 2,800 ohms, respectively, and will supply 45, 90, 135 and 180 volts. A 220-volt tap may be taken from a point

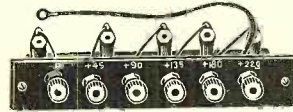

between the two filter chokes. The instrument has a bakelite terminal strip and two angle supports; the entire assembly is held together by a long threaded rod.

AWARDED THE RADIO NEWS LABORATORIES CERTIFICATE OF MERIT NO. 2500.

A.C. RADIO RECEIVER

The "Philharmonic" A.C. 7-tube radio receiver submitted by the Trutone Sales Company, 114 Worth St., New York City, is designed to operate directly from the 110-volt 60-cycle circuit; it employs four 226-type R.F. tubes, one 227 detector, a 226 in the first A.F. stage and one 171A. Three stages of tuned radio frequency follow an untuned antenna stage;



the tuning inductors are of small-field type and are arranged to eliminate coupling. The power switch of the set is found directly below the tuning dial. The knob at the right of the escutcheon operates the four-gang tuning condensers; that on the left of the escutcheon is the volume and oscillation control. "B" voltages are supplied by a full-wave rectifier of the 280 type and an efficient filter system; the power transformer contains windings for all tube filaments. The receiver is encased in a metal cabinet of brown crystalline finish, 19½ inches long, 12½ inches wide and 8½ inches high; a 10-foot extension cord is supplied for connection to the light-socket. When tests were conducted, selectivity was found to be obtained without impairment of the sensitivity; while quality and volume were satisfactory.

AWARDED THE RADIO NEWS LABORATORIES CERTIFICATE OF MERIT NO. 2501.

"B" POWER COMPACT

The "Type R-280" "B"-power compact manufactured by the Thordarson Electric Mfg. Co., 500 W. Huron St., Chicago, Ill., is designed for use in con-

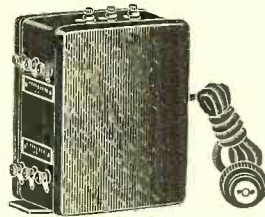

nection with the 280-type (full-wave) rectifying tube; it contains a power transformer of three secondary windings and two 30-henry chokes. The high-voltage secondary is of the center-tapped type, 300 volts to each side; two 5-volt windings are included to supply the filaments of the rectifier tube and the 171 power tube. This compact is designed for use where not more than 25 milliamperes of current is required for maximum set operation. The housing, of black crystalline finish, is 6 inches high, 5¼ inches long and 3¼ inches thick.

AWARDED THE RADIO NEWS LABORATORIES CERTIFICATE OF MERIT NO. 2502.

ELECTRODYNAMIC SPEAKER

The "Type F" speaker submitted for test by the Atwater Kent Mfg. Co., 4700 Wissahickon Ave., Philadelphia, Pa., is of the electrodynamic moving-coil type. The field winding is of the high-voltage type requiring 90 to 100 volts; necessary current is supplied from the "B"-power unit of a radio receiver of the same manufacture. The cone, approximately 8½ inches in diameter, is anchored to the speaker's chassis or frame by thin chamouis strips, ⅞-inch in width, which are cemented around the edge of the paper cone. The complete speaker chassis

is fitted into a drum-shaped metallic housing, which contains several apertures in the face and back for the passage of the sound waves, while serving also as a baffle for the low-frequency cut-off; it is 11½ inches in diameter, 12 inches high over-all, and 8 inches deep. The moving-coil circuit of this speaker does not include the customary step-down transformer; so that, unless the speaker is used in connection with a radio receiver designed for use with it, a special step-down transformer is required. An extension 6-foot cord, terminating in a four-prong plug of the UX type, is supplied for connection to the socket supplied in such a set.

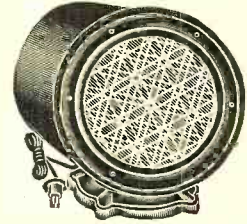

AWARDED THE RADIO NEWS LABORATORIES CERTIFICATE OF MERIT NO. 2509.

FILTER-CONDENSER BLOCK

The "Type BC-280" filter-condenser block submitted by the Aerovox Wireless Corporation, 70 Washington St., Brooklyn, N. Y., has been designed especially for use with the power compact described above (No. 2502). Condenser sections of 2, 2, 4, 1, 1, and 1 mf. capacity, respectively, are provided; the 2-mf. sections are rated for 400 volts D.C. continuous operation, the 4-mf. section is rated for 300 volts D.C. continuous duty, and the three 1-mf. sections are rated at 200 volts D. C. continuous operation. The terminals, of the pigtail type, are brought out from the metallic can through a spacing strip of bakelite. Two common terminals are supplied, one for one side of the first 2-mf. sections and one side of the 4-mf. section, which is indicated as the high-voltage common. The low-voltage common includes the other side of the 4-mf. section and one side of the three 1-mf. sections. The condenser sections are placed in a metallic container 5 inches long, 5 inches high and 3 inches wide over-all, which is filled with an insulating compound; the respective sections have measured capacities within 10 per cent. of their rated value. When this block was used in connection with the "R-280" compact, a humless "B" power supply was obtained.



AWARDED THE RADIO NEWS LABORATORIES CERTIFICATE OF MERIT NO. 2511.

RECTIFYING AND RECEIVING TUBES

The "Type RX-280" rectifying tube submitted by the Raytheon Mfg. Co., Cambridge, Mass., is of the full-wave type, and designed for use in "B" power apparatus operating from a 110-volt 60-cycle circuit; it has an oxide-ribbon filament which requires for normal operation two amperes at five volts. The tube is rated for maximum voltage of 300 volts A.C., per plate, with a constant load output of 125 milliamperes D.C.; it is equipped with a UX base.

AWARDED THE RADIO NEWS LABORATORIES CERTIFICATE OF MERIT NO. 2512.

(Continued on page 791)

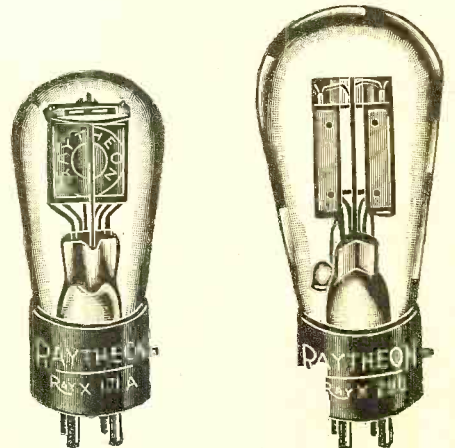

The Radio Constructor's Own Page

Wherein Custom and Home Set Builders and Experimenters
All Over the World Swap Experiences and Suggestions About
Hookups and Accessories

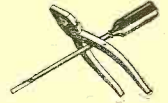

HELPING THE YOUNGSTERS

Editor, RADIO NEWS:

I am a professional set-builder, and am in the "game" to make all the money that there is to be made; yet, I have assisted seven youngsters, all under fifteen years of age, in building their RADIO NEWS receivers without one cent in return. They were so happy that I am satisfied. Four of them built the Two-Tube Reflex from Blueprint No. 60. Six have built the R.F. Booster Unit from Blueprint 54, and now all seven of them want to build the "Milk-Shaker Special" which appeared in the October issue of RADIO NEWS.

These boys are from families that cannot afford to buy a radio set. The boys save their earnings from the sale of papers and I buy the parts for them at wholesale rates. Then I show them what to do and how to do it. I have sold three fine custom-built receivers through these boys, so I feel that I have been repaid.

I have practically every issue of RADIO NEWS intact, since May, 1924. The issues prior to that have been condensed and bound. The complete copies look almost as fresh as though they were just off the newsstands, yet I have read them from table of contents to classified ads. The same holds true with your other magazine. I have every issue of PRACTICAL ELECTRICS and THE EXPERIMENTER without a miss.

I am going to bind them in book form, removing only the covers, according to an article in SCIENCE AND INVENTION. Indexing them will make a reference encyclopedia that is absolutely priceless. In binding the issues prior to May, 1924, I discarded the articles that I did not understand, keeping only the ones that I did understand, I find that I have discarded some very valuable data that can never be replaced.

JAMES A. FIELDS, JR.,

218 West 23rd St., Chicago, Ill.

(Mr. Fields is to be complimented on his good work which, no doubt, takes a good deal of his valuable time. RADIO NEWS has always encouraged such attention and is glad to be of assistance in the education of our future radio engineers.—EDITOR.)

THE CONDENSER TALKS

Editor, RADIO NEWS:

Relative to radio mysteries which you mention in the January issue of RADIO NEWS, I do not suppose the case that I am to speak of is any real radio mystery; however, I used to meet with it quite often.

At one time I used to live about 500 ft. away from our powerful local station WBZ. I was using a three-circuit, regenerative one-tube receiver. For an aerial I used 150 feet, outdoors.

On several evenings after I had turned off the bulb, while all other connections were there, I would hear the broadcast just the same, although faintly. The vibrations seemed to be coming up from the condenser plates and not from the phones, but

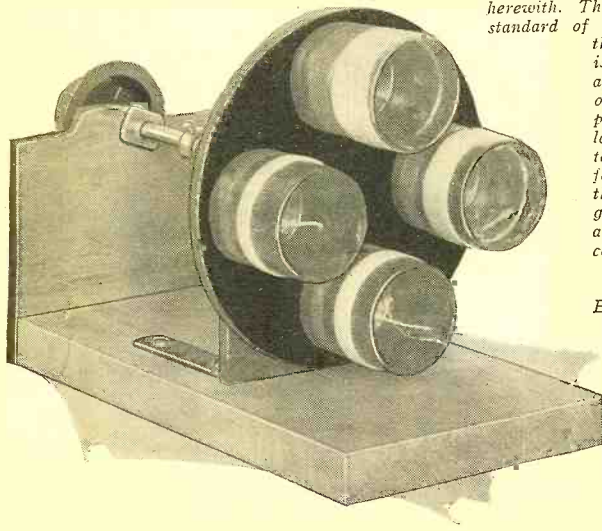

INQUIRIES for information not given here should be sent, not to RADIO NEWS, but to the constructor direct—but he should NOT be asked to furnish data already published, here or elsewhere, or for instructions that an experienced builder should not need; for this is not a beginners' department. Courtesy demands that such requests should be accompanied by postage; as they are often very numerous. Reply coupons can be obtained from the postoffice for international inquiries. On the other hand, readers who solicit general correspondence must expect to bear their own share.

This department is for free discussion to the extent that space permits; but RADIO NEWS accepts no responsibility for the opinions of readers as to the relative merits of apparatus and circuits.

Letters describing good results, but which do not explain the system used, are unsuited for publication; as they entail too much needless correspondence for the editors and the contributors. Give the details the first time.

only at one particular setting of the plates. Of course the broadcast was indistinct and sounded muffled.

WALTER M. BECKWITH,

P. O. Box 172, Springfield, Mass.

A WELL-MADE "PLUGLESS" SET

Editor, RADIO NEWS:

I am sending you a model of my switch for changing coils from one waveband to another; I am inclined to believe it is better than the switching system of the "Plugless" system described in the December issue of RADIO NEWS.

I use four coils to tune from 20 meters up to 100 meters; by the pulling out of the pin and turning it you remove one set of coils, and replace with another. To change the coil assembly, it is necessary only to remove the nut from the rear end of the shaft and pull off the disc with the coils mounted on it. The rest of the construction will speak for itself.

RICHARD E. LAWRENCE,

Box 33, Newport, New Jersey.

(Mr. Lawrence's model, unfortunately, suffered the breakage of its panel in the mails—strong boxing should be put on any piece of apparatus which is to be sent by parcel post or express, as considerable pressure may be put upon it before its arrival. However, this makes clearer the construction, which is illustrated herewith. The work is above the standard of accuracy for which the average constructor is equipped, however; and we should not recommend trying to duplicate it without a good lathe. The operator can tell from the front, by feel, when the prong of the right hand coil engages the notch shown; a pull forward then seats the lowest coil in the jacks below.)

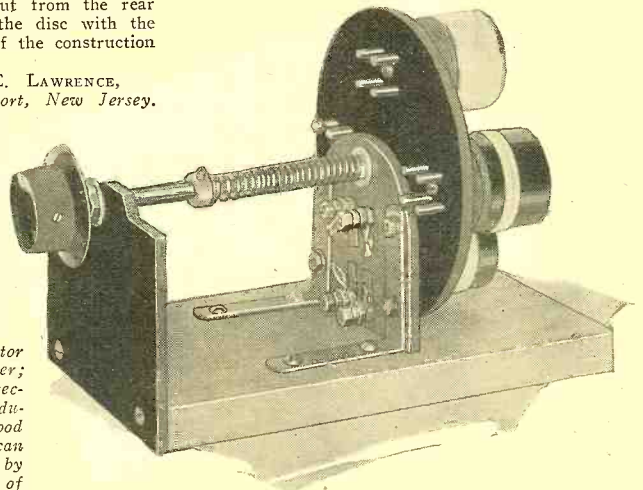

THE ORIENT TUNES IN

Editor, RADIO NEWS:

I have been reading RADIO NEWS and other radio magazines for quite a long time and find it very interesting to read of the efforts and accomplishments of American radio specialists. There are vast differences in matters pertaining to radio here and in the States, principally in the number of broadcast stations; for they are as thick as flies in your country, while they are as scarce as hens' teeth over here. We have about a dozen odd stations here in the Far East within a radius of two thousand miles; so you will see that the problem of selectivity does not enter here except in the matter of code inter-

(Continued on page 787)

A MUSICAL DOOR

Editor, RADIO NEWS:

I have what I call a "hidden speaker" which gives good results. It is made by using the panel of an inner door as a diaphragm; of course, one should be selected which is not in use. The unit is mounted on a cross-arm behind the door, next to the wall. I am using an Enco unit.

JOHN W. POTTS,

913 Seward Ave., Akron, Ohio.

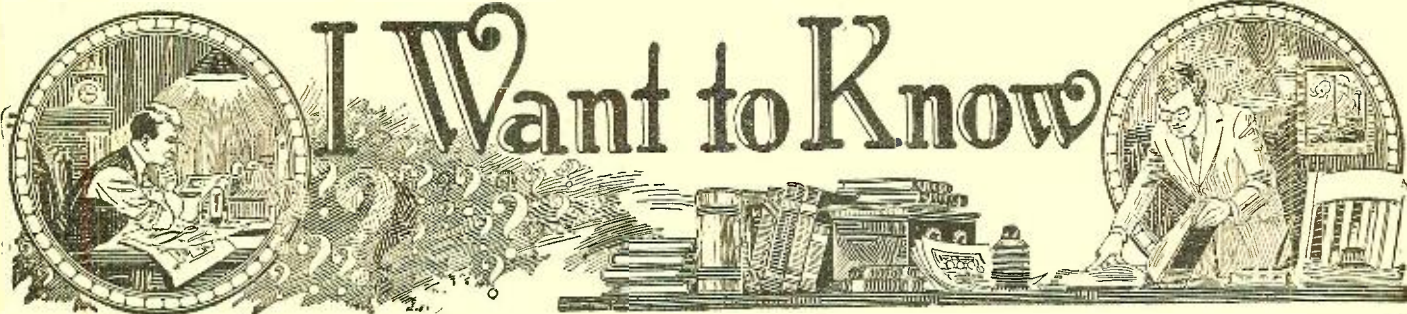

Conducted by C. W. Palmer

We cannot supply blueprints of manufactured apparatus; only RADIO NEWS blueprints, which should be asked for on the coupon printed elsewhere. We cannot send magazines, books, dia-

grams, etc., C. O. D. Please read the instructions and do not use pencil or postal cards. RADIO NEWS sells no apparatus, does no custom building, and can not advise "the best set to buy."

RADIO NEWS readers send in every month an average of 5000 letters asking information on every phase of radio theory, construction and operation. We can only print the five or six replies which are of widest general interest.

those asking for sketches, diagrams, data, etc., should send TWENTY-FIVE CENTS FOR EACH QUESTION: failure to enclose this will cause delay. We cannot answer for this sum questions requiring original research, intricate calculation, or patent investigation; we cannot compare the merits of trademarked apparatus, or give constructional data on apparatus whose makers withhold it. We cannot undertake to answer more than THREE QUESTIONS in each letter. If you inquire concerning a circuit which is not a standard, published one, enclose a diagram to save delay.

Other letters will be answered by mail, if inquirers observe these rules: BE BRIEF: TYPEWRITE OR WRITE LEGIBLY IN INK ON ONE SIDE OF THE SHEET ONLY: ENCLOSE A STAMPED ENVELOPE ADDRESSED TO YOURSELF. Many letters are not readable. Simple questions will be answered free;

USING SMALL NEON LAMPS

(2324) Mr. D. Stanton, Superior, Wisc., writes: (Q.) "I have recently purchased several small neon tubes with small semi-cylindrical plates. These tubes are not very satisfactory for television receivers because of the small size of the plates. I wonder if they have any other practical purpose? Can you help me to put these tubes to some use?"

(A.) The radio experimenter will find a number of uses for the small neon tubes which were placed on the market recently. Fig. Q.2324A shows a circuit using one of these tubes with a coil and a variable condenser for use in testing a set for oscillation; it may be used also for testing the oscillator in a superheterodyne set. If the tube lights when the condenser and coil are in tune with the oscillator, the oscillator may also be considered to be operating correctly. By calibrating the condenser with a regenerative receiver when tuning in various signals and then making the detector oscillate, the unit may be used as a wavemeter. When calibrating the unit, the regenerative receiver should be tuned to different stations and the wavelength of each noted on the scale of the condenser of the neon unit.

Another use for the neon lamps is in testing "B" power units. If the power unit is working, the tube will glow when connected across the maximum terminals. In this case the tube replaces the usual high-resistance voltmeter required to test these units. By connecting one of the lamps across the terminals of a "B" power unit, a constant indicator that the unit is connected to the power lines will be available. The neon lamp can then be mounted in a prominent place to show when the set is "on" or "off." (Fig. Q.2324B).

Audio-frequency transformers can be tested, by connecting a neon tube, in series with the winding, across the terminals of a "B" power unit or other source of high potential. These small lamps will not glow with less than 150 volts of direct current or 100 volts of alternating current.

The neon lamp makes also a very handy polarity-indicator for high-voltage direct-current supplies. When the lamp is connected to a source of sufficient D.C. potential, the electrode connected to the negative terminal will glow; while the positive side will remain dark. When it is connected to an A.C. supply, both sides will glow, so that this phenomenon can also be used when there is doubt as to the type of current supplied to a certain house.

By connecting the lamp with 150 to 200 volts of direct current, it may be made to flash periodically by placing a condenser across and a resistor in series with the line. A change in either the capacity or resistance will change the period of the flash. When either the capacity or the resistance is constant, the value of the other can be determined by comparing its "flash period" with that of a resistor or condenser of known value. There are also a number of other uses for these lamps which will occur to the individual experimenter. These lamps may be used wherever a high-resistance indicator is needed for testing purposes, because of the extremely small amount of current consumed by the lamp. This value is about 4 milliamperes at 110 volts A.C.

In using the tube for testing the capacity of condensers, use a variable resistor of about 0-500-

000 ohms and connect it in one of the leads to the neon tube. Then adjust it until the tube flickers in and out at a slow, steady rate with a condenser of known capacity connected across the two terminals of the tube. Replace the condenser with the one of unknown value and note the difference in the flickering speed.

These small neon tubes can be used for experimental television reception by mounting several of the tubes in a line so that the entire space

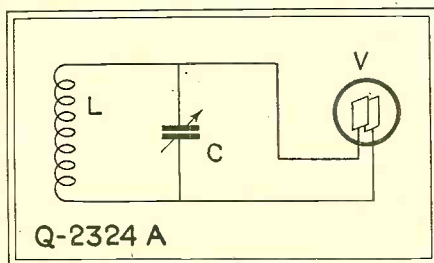

A neon lamp connected to a resonant circuit indicates, by lighting, the flow of current which creates voltage across the plates of the condenser and the ends of the coil.

between the inner and outer holes of the spiral is covered. In this way a much larger image can be obtained than by using only one. The tubes should be all connected in parallel and the two wires connected in the usual manner to the set.

A DIALLESS SET

(2325) Mr. Stephen Jordan, Birmingham, Alabama, writes:

(Q.) "I saw the descriptions of two switch-operated sets in the December issue, but the instructions for each were omitted. I am thinking of building a set and I would like to arrange it so that the local stations could be picked up without the use of any dials. The set will use a screen-grid tube as a radio-frequency amplifier, and contain two stages of audio-frequency amplification. If the screen-grid tube cannot be used in a set of this type, a regular 201A tube will be suitable. Can you supply me with the diagram and instructions for making such a receiver? It will not be necessary to show the audio amplifier, since an ordinary transformer-coupled system will be used."

(A.) Since the design of a switch-operated set will be of interest to a number of constructors, we are printing a diagram which will be suitable, on the next page, as Fig. Q.2325. It contains one stage of (screen-grid) radio-frequency amplification with a regenerative detector; the R.F. circuit is untuned, in order to keep the wiring as simple as possible. The detector is an ordinary 201A-type tube, and tuning in this stage is accomplished by switching semi-variable condensers into the circuit. The condensers for this purpose are so set that a different station will be tuned in by each condenser when it is shunted across the secondary coil. By using several of these instruments, the local stations can be selected without adjusting any tuning controls except the switches. If reception from

distant stations is desired, a variable condenser of the usual design may be mounted in the set and switched into the circuit instead of one of the semi-variable condensers.

The radio-frequency amplifier and the detector are shielded in separate metal cans, and the plate lead of the screen-grid tube is run through a metal tube to shield it from the other wires in the set. This is done to prevent feed-back, which might otherwise occur. The radio-frequency tube is coupled to the aerial through a radio-frequency choke, of a value between 80 to 125 millihenries. The larger inductance is preferable, although good results can usually be obtained with a smaller one.

Grid bias for the R.F. amplifier is obtained from a single 1½-volt flashlight cell connected as shown in the diagram. The screen-grid and the plate circuits of the radio-frequency tube are isolated by placing a radio-frequency choke in series with each of these leads and connecting a by-pass condenser to the filament circuit; the reason for these precautions is explained in the answer to the following question, No. 2326. The coupling coil in the set is specially constructed, with a large primary which allows the radio-frequency tube to operate properly.

Construction

The first thing to do when building the set is to make the coil L2; this may be done in a number of ways with equally good results, but the primary should be made almost equal to the secondary in size, regardless of the construction. A large primary is needed to give the necessary impedance for the plate of the screen-grid tube and also to give the greatest amount of coupling between the primary and secondary. A suitable coil may be made by winding a secondary of about 80 turns of number 22 D.C.C. wire on a tube 2 inches in diameter; the primary should be slot-wound on a tube or spool, 1¼ to 1½ inches in diameter, and placed inside the secondary coil. The fixed tickler is wound on the same tube as the secondary; it contains about

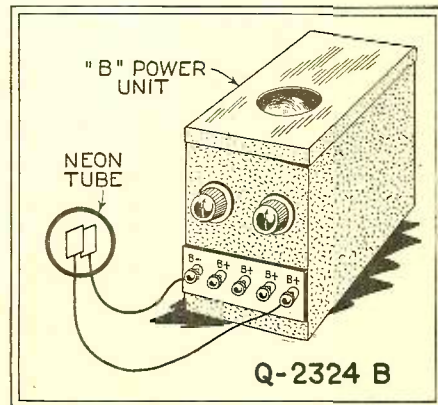

The neon glow-lamp, arranged in this fashion across the terminals of a power unit, lights when it is in operation, but draws very little current.

40 turns of the same wire used on the secondary. A space of about 1/4-inch should be left between the two windings on the tube.

Other parts required for the set, exclusive of the audio-frequency amplifier, are as follows:

- One screen-grid (222-type) tube, V1;
- One 201A-type tube, V2;
- One aerial choke coil (85- to 125-millihenry) L1;
- Two radio-frequency chokes (about 85-millihenry) L3, L4;
- Two semi-variable condensers, .0001-mf. maximum, C1, C2;
- Four semi-variable condensers, .0005-mf., C3, C4, C5, C6;
- One grid condenser, .00025-mf., C7;
- One condenser, .002-mf., C8;
- Two by-pass condensers, 1-mf., C9, C10;
- One fixed condenser, .00025-mf., C11;
- Two filament ballasts, one 222-type, R2; one 1/4-amp. type, R3;
- One grid leak, about 2-megohm, R4;
- One variable resistor, 0-500,000-ohm, R5;
- Three S.P.D.T. switches, panel-mounting, cam-operated type, Sw1, Sw2, Sw3;
- Two shield cans, aluminum or copper;
- One panel and baseboard, to suit layout and amplifier;
- Eight binding posts;
- Two tube sockets;
- One dry cell, 1 1/2-volt "C";

Hookup wire, screws, copper tube for plate lead, etc. The set now may be assembled. The switches are mounted on the panel in a line. The volume-control resistor R5 is also mounted on the panel and, if a variable condenser is to be used as an auxiliary control for tuning in stations not covered by the switches, its dial is also panel-mounted. If a condenser of this type is desired, it should have a capacity of about .0005-mf. In laying out the parts, the coils L1 and L2 should be placed in the middle of the can, leaving a space of at least an inch between the coil and the shield. The control grid lead of the screen-grid tube must be made as short as possible to obtain the best results. The plate lead of this tube should also be short and, as mentioned above, should be run through a copper tube, which is then grounded very carefully.

Operation

After the set has been assembled, the condensers are adjusted. First adjust C1 to the station with the lowest wavelength of those to be received. This is done by turning on the set and then adjusting the condenser screw with a rod of wood or other insulator. Care must be taken to tune the condensers to optimum settings, as the volume and efficiency of the set for each station depend on this adjustment. After C1 has been tuned, each of the other condensers is adjusted to its respective station by switching it into the circuit and tuning it in the same manner as the first one.

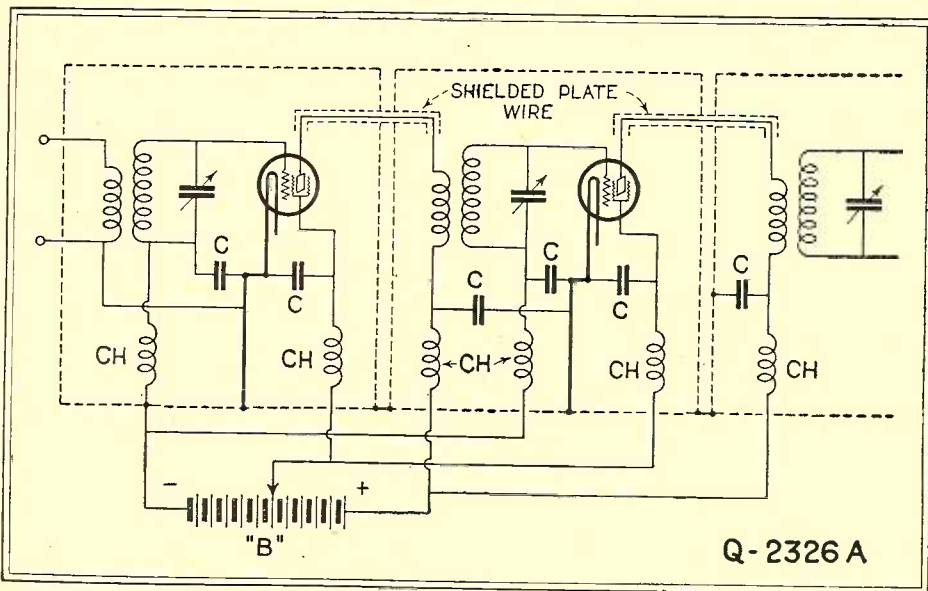

So sensitive is the screen-grid tube that its elements should be shielded against capacitive and magnetic pick-up, even through its short control-grid lead; and it is necessary also to use chokes in the screen-grid lead to keep out R. F. currents caused by battery coupling.

The only other control on the receiver is the oscillation control R5, which acts also as a volume control. For local stations, this resistor may be set and left in a position at which there is no oscillation but which yields sufficient volume for ordinary needs. If body capacity is noted when the switches are adjusted, the panel should be shielded or, if they are made with insulated, metal frames, the frames should be grounded to the shields. It is a good plan to engrave the panel with the call letters of the station opposite the switches, so that anyone can tune the set without knowing the particular arrangement.

An interesting variation of this arrangement, for the enterprising experimenter, is a relay system to connect the various condensers from a distance, which will give remote control of the set. This arrangement is rather too complicated for the average fan, but it consists mainly of switches at the remote points and relays, instead of cam switches, at the set proper. A "master" switch is also provided, to turn the set off and on without the necessity of going to the set. The switches at the remote points will be similar to those described for the original set; they close a local circuit operating

the relay for the proper condenser. Each relay is provided also with an S.P.D.T. switch to operate the condenser circuits; or a separate S.P.S.T. relay may be used for each station.

SCREEN-GRID CIRCUIT DESIGN

(2326) Mr. A. H. Grindle, Fort Wayne, Indiana, writes:

(Q.) "Will you please explain why choke coils and condensers are used so extensively in radio sets employing screen-grid tubes? In almost every such set I have seen described, a number of coils are placed in the plate leads, and sometimes in the screen-grid leads. However, none of the articles explain why these chokes are employed; can good results be obtained without them or are they necessary for correct operation?"

(A.) Although the circuits for screen-grid receivers do not differ materially from those comprising ordinary tubes, there are several points of difference which must be considered if effective results are to be obtained. It must be remembered for one thing that these tubes give very great amplification when used correctly. Also, the screen-grid tube does not require any neutralizing device to operate successfully and this alone is of great assistance in constructing multi-tube receivers.

The fourth element (the screen-grid) in this tube prevents any feed-back through the capacity of the tube elements; but, because of the very high amplification possible, it is necessary to use extreme care in shielding the receiver to prevent any interaction due to the capacities between wires, etc. The shielding for such a set should be effective as both an electromagnetic and an electrostatic shield.

With reference to the actual construction of the set, there are several rules which should be followed: use the best components available and be sure that they are designed for use with a screen-grid tube. All parts are not suitable even though they are well made otherwise. The coils should have a ratio of primary to secondary turns, about 1 to 1; or, if impedance coupling is employed, the impedances should not be tapped to produce a step-up ratio of the turns in the primary and secondary.

There is one other point which many a radio fan has discovered, much to his sorrow, in the use of the screen-grid tube as a radio-frequency amplifier. As an example, suppose we build a completely shielded set and use extreme care to prevent any interactions due to faulty shielding. We use the very best apparatus that we can obtain but, when the set is finished, we discover that the amplifier is uncontrollable and has a bad tendency to oscillate. In fact, the better the apparatus that we use, the greater will be the tendency to oscillate. We can cure this trouble by introducing resistors into the circuits; but this method is not desirable because it will reduce the efficiency of the amplifier. This leaves us in a very unfortunate position, so far as the operation of the set is concerned; since the only other apparent means of overcoming the difficulty is to reduce the number of turns on the primary coils of the couplers, and this will also reduce the amplification.

Evidently our trouble is due to a feed-back, even
(Continued on page 793)

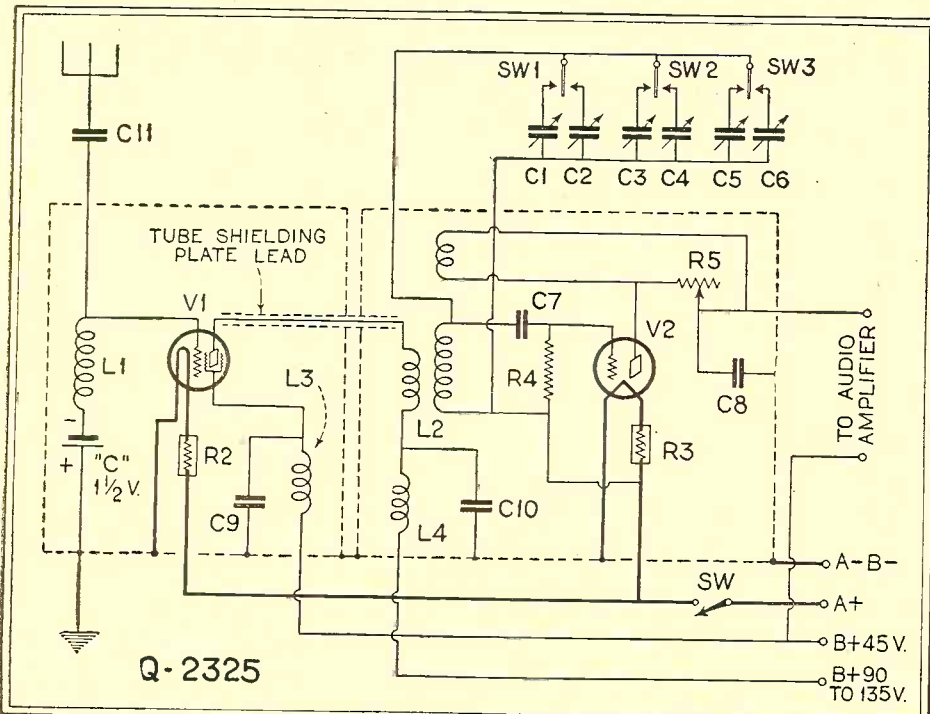

This "dialless" tuning unit will bring in stations with the flip of a switch; the high resistor R5 is the only control. The regenerative detector and shielding give selectivity.

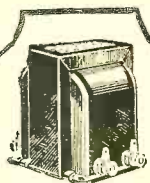

THORDARSON
EQUIPPED

Do You Realize the Importance of this Endorsement?

Each successive year that we use Thordarson transformers strengthens our faith in your organization. Both our laboratory tests and our experience have proven conclusively that Thordarson transformers are in perfect accord with the high standards maintained throughout in Zenith Receivers.

President
Zenith Radio Corporation



ZENITH RADIO
—LONG ESTABLISHED—
AUTOMATIC

IN the last analysis, there is no test for the merits of any product that is more conclusive than an investigation of the customer clientel of its manufacturer. Among the users of Thordarson Radio Transformers you will find the aristocracy of radio . . . leading radio set manufacturers whose receivers are universally hailed as musical instruments of undisputed superiority.

Such an endorsement of performance means much to any purchaser of radio apparatus. It means that Thordarson radio transformers have passed successfully the most exacting tests under the eagle eye of the laboratory.

It means, also, that any receiver equipped with Thordarson power supply and audio transformers can be relied upon for a dependability of service and a fidelity of reproduction that represents the acme of engineering development.

Whether you are buying a complete receiver or building your own instrument . . . if you are seeking the ultimate in radio performance insist on Thordarson Transformers.

Thordarson Electric Manufacturing Co.
Transformer Specialists Since 1895
Huron, Kingsbury and Larrabee Sts., Chicago

THORDARSON RADIO TRANSFORMERS

S U P R E M E I N M U S I C A L P E R F O R M A N C E

Please say you saw it in RADIO NEWS

WO Outstanding Raytheon Achievements



Raytheon Kino-Lamp

Already Raytheon has brought television tubes past the "anything that works" stage to a point where reliability and long life are added to practicability. The Raytheon Kino-Lamp is the long-life television receiving tube—adapted to all systems and made in numerous types.

List Price, \$7.50



Raytheon Foto-Cell

Again, in this sending tube, Raytheon has developed plus-service through long experimentation and research. The Foto-Cell comes in either hard-vacuum or gas-filled types, and in two sizes of each.

Information and prices upon application

Write us for further information regarding Raytheon Television Tubes

RAYTHEON MFG. CO.
CAMBRIDGE, MASS.

What's New in Radio

(Continued from page 722)

to give a frequency-variation curve adapted to the most uniform separation of stations on the broadcast band. The rotors, in all models, are common; being coupled mechanically and electrically by the $\frac{3}{8}$ -inch metallic shaft, which is turned down to $\frac{1}{4}$ -inch at one end to enter the dial bushing.

The compartmented frame supports rigidly and shields the stator assemblies, which are isolated from each other and led to connecting lugs upon bakelite strips for convenient connections. The rear of the frame is provided with recesses, for the convenient attachment of small adjustable condensers to equalize or "trim" the capacities of the units for the purpose of bringing the circuits into resonance over the dial. The solidity of the assembly appears a guarantee of long life and uniform service.

Manufacturer: Hammarlund Mfg. Co., New York City.

A New Form of Solder Which Is Easily Applied

THE constructor who experiences some difficulty when soldering his assemblies may find a solution of his difficulties in an ingenious form of tape solder now being marketed by a mid-west manufacturer. This new wrinkle is made up of a thin sheet of fluxed solder, folded upon itself three times so that the strip is half an inch wide, and is obtainable in two forms; one a metal spool of the solder (resembling a roll of adhesive tape) and holding 60 inches, and the other a package containing a number of five-inch strips.

The strip is perforated in order to allow the flux, which is part of the composition, to reach the metal before the solder, thus insuring a well-soldered connection. Application is extremely simple; a small piece of the tape is wrapped about the joint to be soldered and heat is then applied close to the point to be soldered. The heat may be obtained from a lighted match or an alcohol lamp, as shown in the illustration (Fig. 3).

Manufacturer: Gardner Radio and Electric Co., St. Louis, Mo.

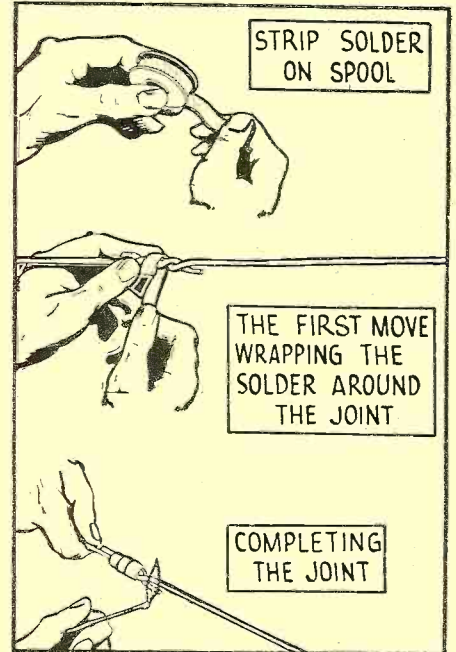

Fig. 3

This solder, in thin strips which carry their own flux, may be used even without an iron.

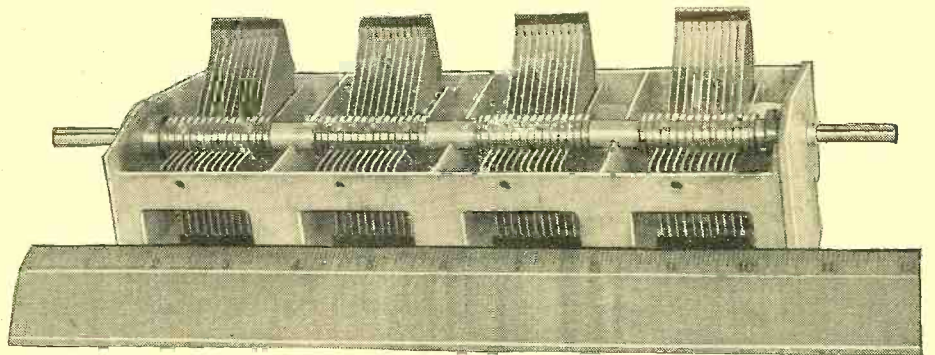

Fig. F

The "battleship" construction of these new gang condensers is obvious; the alignment is accurate.

Argentine to India

WITH commercial service by telephone between America and Europe and between Holland and Java, all records for phone communication have been recently broken. On October 16th Bandoeng, Java, spoke with Buenos Aires, Argentina, via Kootwijk, Holland, and Berlin, Germany. The rather circuitous route of the message covered about 16,000 miles.

It is proposed also to link the British empire by telephone, using the beam systems which communicate with Australia, South Africa and India in the same manner that the Rugby station connects with America over two channels.

Canadian Radio-Telephone

YEARS ago, as soon as the radiophone transmissions had become intelligible, it was suggested that they would supersede the use of wires. This was very quickly scouted, because of the lack of channels; though a regular radio-telephone link was maintained for some time between Catalina Island and the mainland of California.

In order, however, to give telephone service to isolated communities in British Columbia, steps are now being taken to organize a company to operate radiophone service where the country is so mountainous and scantily-populated as to make wire service impracticable.

Books no home should be without

HOUDINI'S SPIRIT EXPOSES and DUNNINGER'S PSYCHICAL INVESTIGATIONS

By JOSEPH DUNNINGER

In this remarkable new book the voice of Houdini has been resurrected, as though from the dead, and can be heard to echo again in sullen denunciation of the ever-increasing number of spiritualistic mediums who, since his decease, have been parasitically bleeding the innocent public of its choicest possessions whilst posing in the sacrilegious guise of the living dead.

Joseph Dunninger, famous magician, Chairman of the Science and Invention Investigating Committee for Psychical Research and the author of several notable works on magic, was a close personal friend of the late Harry Houdini. All the data appearing in this book was taken from the personal notes of the dead magician now in the possession of Dunninger. These and the accompanying remarkable conclusions drawn from the various successful exposés of Houdini, together with the tremendously interesting revelations contained in Dunninger's Psychical investigations, make this a book that all should read. Over 116 pages. Large 9x12-inch size.

Only
50c
Per Copy

At all newsstands
or write direct

BEAUTY SECRETS

By EVA NAGEL WOLF

This book, by Eva Nagel Wolf, prominent editor of the beauty column of one of the leading women's magazines and internationally known authority, divulges to seekers of beauty the true secrets of their type—just what is necessary to make themselves most attractive. "BEAUTY," says Miss Wolf, "is not difficult to obtain once you have learned the simple secrets of type." It is the purpose of this book to pass on to every woman these secrets—to show her the quickest and easiest way to genuine beauty and attractiveness.

There is nothing left unsaid—every phase of beauty culture is fully treated. The art of make-up, care of the hands,

the hair, the eyebrows and lashes; adding that extra pound or taking off excessive weight—all is covered.

BEAUTY SECRETS should be every woman's constant companion at the boudoir. Critics the country over have claimed that a fair price for a book of this kind would be from three to five dollars. However, due to our unique way of publishing, we are able to give this book to you at the phenomenally low price of—

50c
Per Copy

Sold at all newsstands or
write direct—112 pages—fully
illustrated—large magazine size

POPULAR CARD TRICKS

By WALTER B. GIBSON

Pleasant Entertainment for All

Walter B. Gibson has written what is conceded to be the most complete book of card tricks ever published. There are literally hundreds of these clever little tricks. You need not be a professional in order to work them out. There is no sleight-of-hand required. You can do any of them with little or no practice. Simple to perform—difficult to guess. Complete instructions—hundreds of illustrations.

Once you have mastered a few of the tricks that this book contains you will become extremely popular—always entertaining. Imagine the fun you can have at a party. Just nonchalantly pick up a deck of cards and inquire if anyone has "seen this one." Then, while all attention is focused on you do these tricks one after another to the admiration and wonderment of all.

This big book of entertainment,
fully illustrated—large
magazine size

Only
25c
Per Copy

At all newsstands
or write direct



EXPERIMENTER PUBLISHING CO., Inc.

230 Fifth Avenue
New York, N. Y.

EXPERIMENTER PUBLISHING COMPANY, Inc.
230 FIFTH AVE., NEW YORK, N. Y.

Gentlemen:
I desire the books checked below and an enclosing \$.....
in full payment of same.
 Houdini's Spirit Exposés Beauty Secrets
 Popular Card Tricks

Name
Address
City State

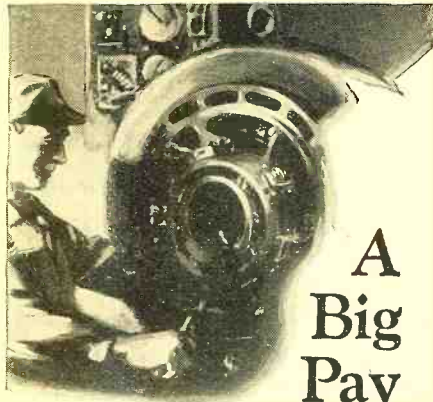

A Big Pay Job for You in ELECTRICITY

THIS giant industry is constantly calling for more trained men to earn \$70 to \$200 and more weekly. Here is an entirely new, easier way to fit yourself for a big pay job in electricity.

Real Movies, at Home Make Every Point Simple

In Film-Way training you use actual motion pictures in your home—we supply everything needed at no extra cost. See inside of great power plants, broadcasting stations, close-ups of men doing electrical work, moving diagrams that make the facts simple as A B C.

We Help You Get the Job

Free employment service with course puts you in touch with employers who want Film-Way trained men. We pledge in writing to give you training and service necessary to get you a better job and more money *or you need not pay a cent!*



\$75 Movie Projector Given

Every student gets as his own property a standard \$75 DeVry moving picture projector. So simple anyone can operate it. Uses light socket, farm power plant or auto battery. Thousands of feet of film supplied for use during course.



FREE Send Now For This Big Book "The Film Way to Bigger Pay"

Explains and pictures how we use movies to fit you for bigger pay. Get your copy; send the coupon *Now!*

Representatives with School Experience Wanted

The NATIONAL SCHOOL of VISUAL EDUCATION

"The Film Way to Bigger Pay"

537 S. Dearborn St., Chicago, Ill., Dept. 2D
Send free book, "The Film Way to Bigger Pay" and details of your complete course in Electricity

Name Age

Sr. or R.F.D.

City

State

Television Happenings

(Continued from page 719)

December was the formation of a \$10,000,000 concern to finance the sale of television transmitters and receivers developed by C. Francis Jenkins, the noted Washington inventor, whose activities have been given much space in RADIO NEWS. It is not yet known just what specific instruments this company intends to market.

The Jenkins company is being backed by a group of financiers whose names are so well known in the financial world that great things are being expected of the organization. Mr. A. J. Drexel Biddle, Jr., chairman of the board of directors, has issued a conservative statement in which he predicts, without mentioning specific dates, "the early realization of practical television reception in every home." In referring to one of Mr. Jenkins' latest achievements (obviously the picture board described on page 536 of RADIO NEWS for December, 1928) Mr. Biddle states: "Mr. Jenkins has provided a television system whereby magnified images are available for the home, so that the entire family can see them at one time. A further development permits of projecting the television images on a large screen so that they may be shown in a small theatre. It is only a question of refinement in attaining the proportions and the luminosity of the usual motion picture screen, so that our future theatre audience may see news events of the moment rather than of the past."

Use of Grid Leaks

THE values of grid leaks are usually specified in a hook-up, at from 2 to 5 megohms; the specified value depending, apparently, on what the constructor had handiest. The value is not very critical; the tube manufacturers set the limits between 2 and 9 megohms. It is to be borne in mind that the grid leak regulates the value of negative charge which can accumulate on the grid. The higher the resistance of the leak, the greater the charge; and in some cases, on strong signals, it may block the tube. With a low-resistance leak, the charge drains off quickly, and the tone quality is less subject to distortion; on the other hand, the detector is less sensitive to weak and distant signals. On a DX hunt, therefore, a grid leak of very high value may well be used. Either an assortment of grid leaks of the usual type, or a single variable (carbon-compression) grid leak may be used; but if the latter is employed, it must be of the quiet type.

HOW ABOUT NORTH DAKOTA?

NE: "Television ought to be a big hit in Missouri."

OX: "Why so?"

NE: "Well, you know, you've got to 'show them' in that state?"

—Wm. G. Mortimer.

WHETHER NEEDED OR NOT

MUSICALLY-INCLINED CUSTOMER: "And how often will I have to have it tuned?"

SALESMAN (furniture "expert"): "Er, ah—well, it would be a good thing to have it tuned whenever the tuner comes around."

—Morris Cavanah.

Cunningham RADIO TUBES



Each Cunningham Radio Tube speaks with a note of authority on tone Quality.

E. T. CUNNINGHAM, INC.
New York Chicago San Francisco

Ask for them by Name



Everything in Radio at Wholesale

We supply every radio need from our mammoth stock of kits, parts and sets of latest design. Lowest wholesale prices. Expert attention; immediate service. Write for big, illustrated Catalog "B-4."

Allied Radio CORPORATION
711 W. LAKE STREET, CHICAGO

SET BUILDERS

write for Discount Card

Enabling you to purchase the new and Improved Knapp "A" Power Kit at big discount—Write for full particulars.

DAVID W. KNAPP, Pres.

Knapp Electric, Inc.

Division of P. R. Mallory & Co. Inc.

Room 417a, 350 Madison Ave., N. Y. C.

NEWS to Set Builders

Barawik offers set builders bigger bargains—bigger opportunities to make money this season. New sets, new kit ideas, all the leading parts, dynamic speakers, supplies, etc. Lowest rock-bottom prices. Bigger stocks, quicker service. Send for Big Bargain Book today—free.

BARAWIK CO., CHICAGO, U. S. A.

Mail This Coupon Now! For Free Copy

Name

Address

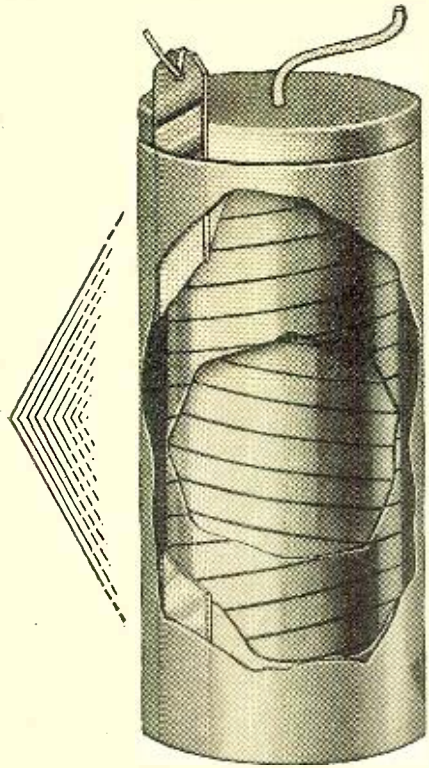

NEW

ANTENNA and GROUND *Combined in one convenient Unit*

A wonderful thing has happened in radio! Convenience never before dreamed of! Clearer, sweeter-toned reception! Radio pleasure with less interruption! These things are brought to you by the amazing, tested, approved, EARTHANTENNA.

Many set owners have come to realize the importance of using a dependable antenna, also the value of perfect grounding in getting good reception. Now science has gone a step further; it says that the LOCATION of the antenna is an equally important factor in getting best results. Because the radio wave goes right into the earth—where obviously there is less atmospheric disturbance and interference—it is claimed the logical place for the antenna should be the EARTH, not the air. This important conclusion allowed Radio Engineers to work out the EARTHANTENNA.

Reduces Static— Gets Clearer, Sweeter Tone

Have you ever listened to reception that almost took your breath away with its faultless reproduction, its pure melodious tone? And then gone home and compared its haunting beauty to YOUR receiver's often unsatisfactory, static-ridden performance? Probably nine out of ten set owners who formerly thought they were getting "pretty good" reception have had this experience.

They accepted the shrieks, whistles, knocking and howls due to atmospheric conditions—the weak, faulty results of sagging, broken, or soot-laden aerial wires—the interference of other aerials or power line noises—the fading often caused by corrosion or imperfect contact in an unscientific ground—all as necessary evils.

Progressive radio refused to stop there. The new scientific, successful EARTHANTENNA is designed to give you clearer, better, more dependable reception—and it costs no more than the old inefficient aerial—in fact less than many.

EARTHANTENNA is so easy to install that soon people will wonder how they ever put up with the old, dangerous, slow methods. You simply dig a small hole only two feet below the surface of the ground, drop the EARTHANTENNA into it and attach the lead-in wires to your set. Now you are ready to listen to earth-clarified, sweeter-toned ground-wave reception. You never need to touch the EARTHANTENNA again.

Shielded Antenna Gets Better Reception

The antenna is insulated or "shielded" against electro-static disturbances as are the most advanced, expensive receivers and their various parts. Science declares that the earth itself "shorts" the electro-static capacity before it reaches the Antenna. This acts as another shield. The ground element is constructed of copper, undisputed as the most effective material for obtaining a perfect ground connection. This section of the unit is separated from the Antenna by the insulation which shields the Antenna. So in the EARTHANTENNA you have a scientific ground and an antenna of modern shielded construction combined in one compact unit. You can test it yourself right now at our risk. Hear the wonderful results!

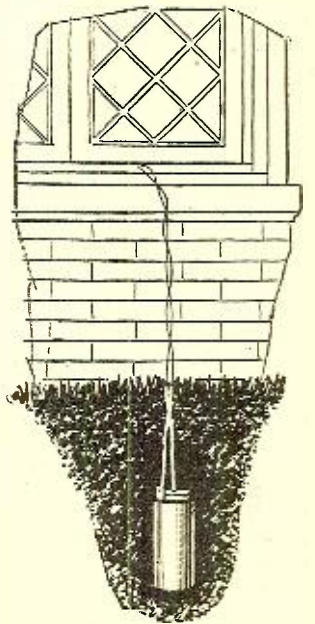

Test EARTHANTENNA at OUR Risk

Let EARTHANTENNA prove its own value without your risking one cent. Don't remove your old aerial and ground until you've compared the old and modern methods and hear the vast improvement with the new. If possible pick a time when static is bad. Then if you are not convinced that EARTHANTENNA is the greatest discovery you've ever found for your radio—if you are not enthused over the improvement—you don't pay us a cent. The thrilling details of this important development—illustrated—will be sent immediately on receipt of this coupon. Mail it NOW!

The Modern Antenna Company

Dept. 827B St. Clair Bldg., cor. St. Clair and Erie Streets
CHICAGO, ILL.



THE MODERN ANTENNA COMPANY
Dept. 827B, St. Clair Bldg., cor. St. Clair and Erie Sts.,
Chicago, Ill.
Rush literature on EARTHANTENNA and Free Trial Offer.
No obligation.
Name.....
Address.....
City.....
State.....

Please say you saw it in RADIO NEWS

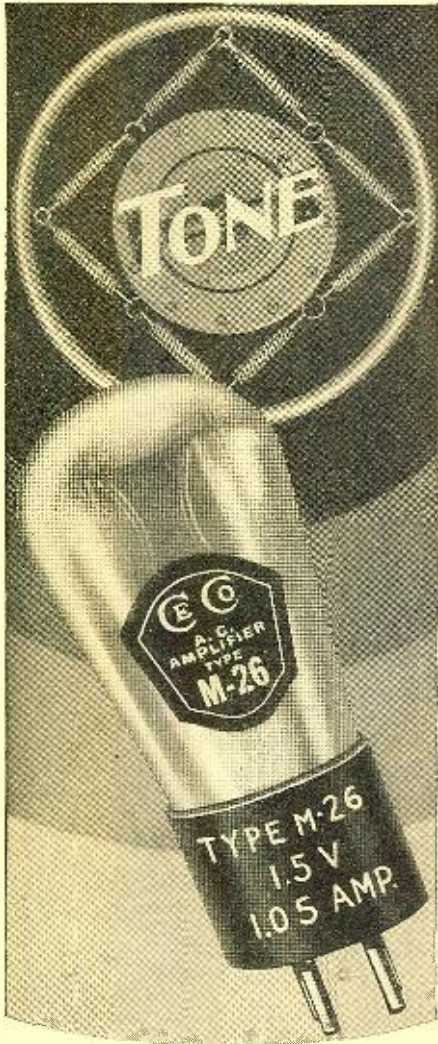

Clear Silver Tones ~ from the microphone to you

EXPERT workmanship, correct design and the careful selection and testing of all materials are responsible for the great popularity of CeCo tubes.

You'll find a CeCo tube will last longer, perform better and give you more genuine enjoyment from your set.

There is a CeCo tube for every need and they cost no more. They are the best engineered tube in the industry. Sold everywhere.

CeCo Mfg. Co., Inc. • Providence, R. I.



The "Copperclad Special"

(Continued from page 737)

of all short-wave broadcasters, and the first every short-wave listener goes after when trying a new receiver. Stations W2XAF and W2XAD, described in detail in RADIO NEWS for December, 1928, are also reliable stand-bys.

The dials of the tuning condensers C1 and C3, with the coils mentioned, will read more or less alike; although the regeneration condenser C2 never has a definite setting. Start with both the tuning condensers at zero, and turn up C2 until you hear the soft hushing sound indicative of regeneration. Then leave C2 alone and start advancing C1 and C3 together. As mentioned previously, the detector will stay in the regenerative or oscillatory condition for about twenty degrees of tuning-condenser movement. If at any setting you hear a whistle, stop turning the tuning condensers, and shift your left hand to the regeneration condenser. Turn this down slowly and try to clear up the voice or music—if there is any voice or music present.

As remarked in these columns a number of times, the short-wave bands are not as abundantly sprinkled with broadcast stations as the 200-550 meter channels. You have to sit down and exercise a little patience and skill in digging those short-wavers out of the mess of code stations, but therein lies the fun of short-wave reception. You may feel discouraged the first few nights because you can hear only Pittsburgh and Schenectady but, one of these evenings you'll run into 5SW, London, or PCJJ, in Holland, and you'll hear them so loud you'll think they're locals. That will be a real thrill. Many people who have built short-wave receivers write to us saying that they cannot believe their own ears when some of these foreigners pound in like the proverbial ton of bricks; in some places a comparatively near-by station like W8XX or W2XAF will be just nicely audible, while 5SW will make listening with phones distinctly uncomfortable.

The aerial may be almost any piece of wire hanging in space; a single wire, totalling between 50 and 75 feet from the aerial binding post to its far end, is about right. The writer, living in New York City, has picked up code stations all over the world with nothing more than a bed-spring for an aerial. The usual ground to a water or steam pipe is required.

While testing the original model of the "Copperclad Special" the writer ran into a broadcast station on about 25 meters. With no amplification after the detector tube, the signals were so loud that they could be heard about two feet from a cone-type loud speaker connected in place of the phones! Several musical selections were played, and finally the announcer identified the source of the music as CJRX, Winnipeg, Canada, at a distance of about 1,300 miles!

SCIENCE IN 2929

ARCHAEOLOGIST: "This is the skull of a man of the Old Radio Age. We can date it within twenty years."

VISITOR: "For heaven's sake, how?"

ARCHAEOLOGIST: "Look at the evidence of wear around the ears. He used to wear headphones."—Leslie Carpenter.

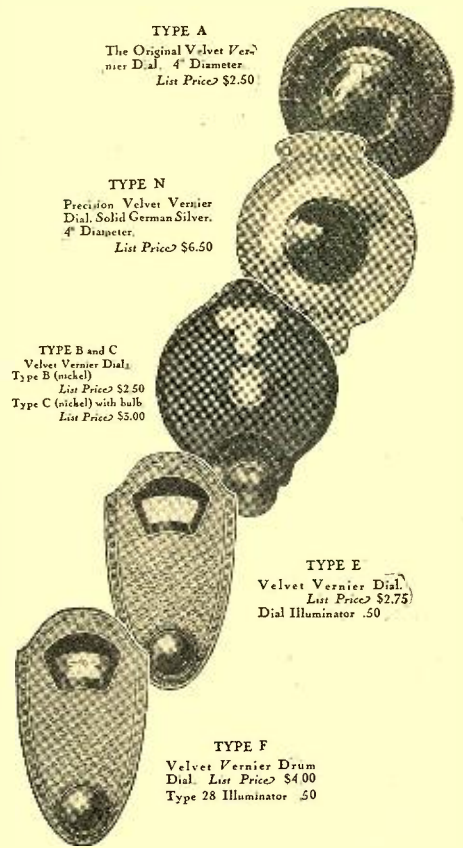

TYPE A
The Original Velvet Vernier Dial, 4" Diameter
List Price \$2.50

TYPE N
Precision Velvet Vernier Dial, Solid German Silver, 4" Diameter
List Price \$6.50

TYPE B and C
Velvet Vernier Dials
Type B (nickel)
List Price \$2.50
Type C (nickel) with bulb
List Price \$5.00

TYPE E
Velvet Vernier Dial,
List Price \$2.75
Dial Illuminator .50

TYPE F
Velvet Vernier Drum
Dial, List Price \$4.00
Type 28 Illuminator .50

FOR EVERY RADIO

There is a National Velvet Vernier Dial for every kind of radio. Radio amateurs and short wave enthusiasts still prefer the Original and Matchless type A. Types B and C, illuminated, are generally used on radio sets and on all kinds of laboratory apparatus. The new solid German silver type N with real vernier, permits logging with greater accuracy than ever before. Types E and F represent the latest designs to conform with modern factory-built-set models.

NATIONAL VELVET VERNIER DIALS

Write for Bulletin 121-RN

NATIONAL CO. INC., MALDEN, MASS.

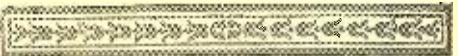

SET BUILDERS

Get this Book

LATEST RADIO GUIDE
FREE

Barawik, the first and oldest radio specialty house, offers you unusual service this year. Bigger stocks, quicker shipments, lower prices. Deal with an old established, reliable house. Get honest goods, honest service, honest prices. Barawik service makes you more money. Send now for big new Catalog showing lowest wholesale prices.

BARAWIK CO. 22-1 Canal Sta., CHICAGO, U. S. A.

Mail This Coupon Now for Free Radio Guide

Name _____

Address _____

ORDER FROM THIS PAGE

Radio at Wholesale

If you prefer that we ship C. O. D., send only 25% of the value of the purchase with your order.

Add additional postage or express charges.

OUR BIG 1929 CATALOG IS NOW READY SEND FOR IT

The greatest value - giving Radio store in America. Our tremendous carload - buying power and huge volume of business is the reason. The most complete line of radio in America. Every item guaranteed by us and the manufacturer.

Mail Orders Given Prompt Attention. 12-Hour Mail Order Service

Star-ko

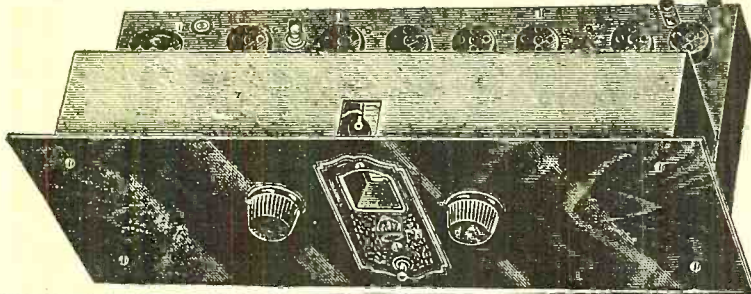

8-Tube All Electric RECEIVER

Here is the latest creation of the great STAR-KO Laboratory, being shown for the first time. It is easily one year ahead.

New—not only the form, but the whole spirit of its styling and engineering. A new 8-Tube circuit, surpassing in performance, revealing great strides in selectivity and tone quality.

A Triumph—the culmination of months of earnest labor, put into its design and construction. A finished product proved by America's foremost engineers. Uses 1-280, 2-171, 1-227, and 4-226 type tubes.

Revel in the wealth of wonderful reception. Turn to any station you choose and hear for yourself the quick response to distant stations, the fascinating clearness of all sounds.

Think of buying this wonderful receiver at this low price. Then you will realize why we say America's Greatest Radio Value.

Panel size—7x18. (List Price—\$85.00) NET PRICE.....Shipping weight 40 lbs.

\$49.95

HEADQUARTERS

For Custom Set Builders.

Complete stock of Silver-Marshall Parts and Tryman Kits.



EXIDE "A" POWER UNIT



Takes the place of both ordinary "A" battery and its charger. Complete with Tungar bulb. A \$35 Value.

Shipping weight 45 lbs.

\$9.95

6-VOLT Abox

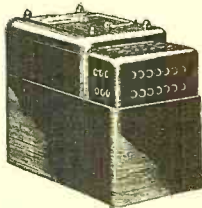

A. C. Converter

Never before has the Abox been offered at this low price. It provides a steady six-volt direct current for your set and with a "B" eliminator it transforms the set to A. C. electric operation. Works only when the set is in operation and does not store up current.

REG. PRICE \$35 Shipping weight 23 lbs. **\$14.95**

BALKITE "J" CHARGER

At More than 60 Per Cent Off. List Price \$17.50

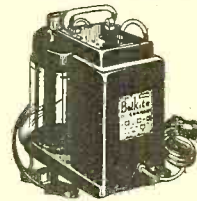

\$6.95

Trickle or Heavy Duty Use Noiseless charger for 4 or 6 volt "A" batteries. Shipping weight 19 lbs.



BIG REDUCTION SAAL Soft Speaker

A quality reproducer of scientific construction, that will not blast or chatter.

\$22.50 value, **\$4.85** Shipping weight 12 lbs.

Now Ready



SPECIAL ELECTRIC SOLDERING IRONS

(List Price \$2.50) **85c** Net Price..... Shipping weight 2 lbs.

GERMAN 3-COIL PHONO-GRAPH UNITS

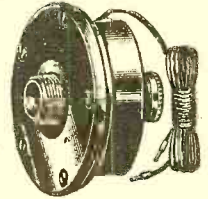

\$2.95

Shipping wgt. 2 1/2 lbs.



RADIOLA 28 Loops 95c

Don't confuse them with the assembled cage type. List \$7.50. Shipping weight 4 lbs.

Dealers and Set Builders

Write for our 1929 FREE Catalog Now!

WILLARD "A" and "B"

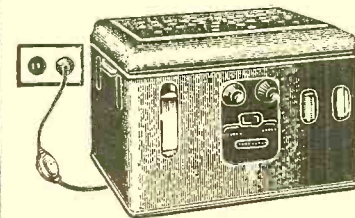

COMBINATION POWER UNIT

The premier of all power units. Convenient, simple, and efficient. It is controlled automatically by the switch of your radio set. Just plug in your light socket. Regular list price \$77.50. Shipping weight 82 lbs.

On Sale at Only **\$29.95**

SET -O- SIX WRENCHES

Consists of handle and five interchangeable sockets, including 1 socket for knurled nuts. (List Price \$1.25) Net Price **74c** Shipping weight 1 lb.

Chicago Salvage Stock Store

The Largest Radio Store in America
509 South State Street
WHOLESALE DEPT. R. N. 16 CHICAGO, ILL.

Brach A & B Power

Control SWITCH

(List Price \$3.00) NET PRICE..... **87c** Sh'ing wgt 2 1/2 lbs.

Please say you saw it in RADIO NEWS

Here's the Answer

to every question about the principles, methods, or apparatus of radio transmitting and receiving.

THE RADIO MANUAL

A Complete Course in Radio Operation In a Single Volume



A Handbook for Students Amateurs Operators Inspectors

For the first time an entire course of training in one book — the most complete and up-to-date work on radio. Developed simply and clearly from the elementary stage right through all phases of principles, practice, and apparatus so that a beginner with no knowledge of electricity may get all he needs either for amateur operation or to qualify for a government license as operator or inspector.

Prepared by Official Examining Officer

The author, **G. E. Sterling**, is Radio Inspector and Examining Officer, Radio Division, U. S. Dept. of Commerce. The book has been edited in detail by **Robert S. Kruse**, for five years Technical Editor of QST, the Magazine of the Radio Relay League. Many other experts assisted them.

16 Chapters Cover: Elementary Electricity and Magnetism; Motors and Generators; Storage Batteries and Charging Circuits; The Vacuum Tube; Circuits Employed in Vacuum Tube Transmitters; Modulating Systems; Wavemeters; Piezo-Electric Oscillators; Wave Traps; Marine Vacuum Tube Transmitters; Radio Broadcasting Equipment; Arc Transmitters; Spark Transmitters; Commercial Radio Receivers; Radio Beacons and Direction Finders; Radio Laws and Regulations; Handling and Abstracting Traffic.

New Information never before available such as a complete description of the Western Electric 5-Kilowatt Broadcasting Transmitter; description and circuit diagram of Western Electric Superheterodyne Radio Receiving Outfit type 6004-C; Navy Standard 2-Kilowatt Spark Transmitter; etc.; etc. Every detail up to the minute.

Free Examination

"The Radio Manual" has just been published. Over 900 pages. Profusely illustrated. Bound in Flexible Fabrikoid. The coupon brings the volume for free examination. If you do not agree that it is the best Radio book you have seen, return it and owe nothing. If you keep it, send the price of \$6.00 within ten days.

Order on This Coupon

D. Van Nostrand Co., Inc.,
9 Warren St., New York

Send me THE RADIO MANUAL for examination. Within ten days after receipt I will either return the volume or send you \$6.00, the price in full. (Radio News 2-29)

Name

St. & No.

City and State

The Radio Beginner— Condensers and Their Uses

(Continued from page 728)

they may be considered as forming one instrument. It is therefore necessary only to add together the individual capacities of the two or more to arrive at the capacity of the combination.

However, when we connect the condensers in series, we change the condition radically. There is no external connection reaching their inner plates, and there is a considerable increase in the time which is required by the combination to charge and discharge.

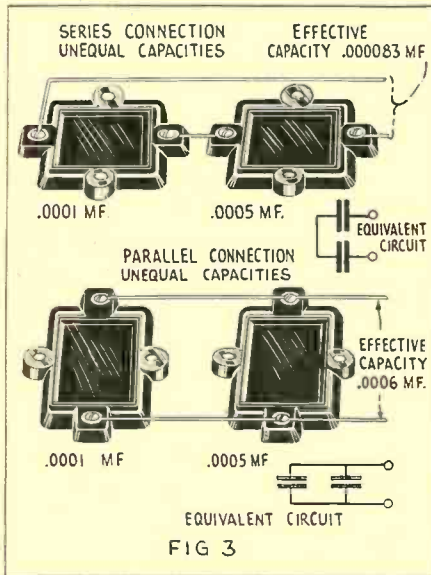

The capacity of condensers in parallel is easy to figure—just add them. That of condensers in series requires the use of "reciprocals"; see page 768 for a handy table of them.

In other words, the capacity of two or more condensers in series is *less than that of the smallest one*. Putting a very large condenser in series with a small one results in a capacity very little less than that of the smaller; if two or more of the same size are linked up in this manner, the capacity of one may be divided by the total number to be

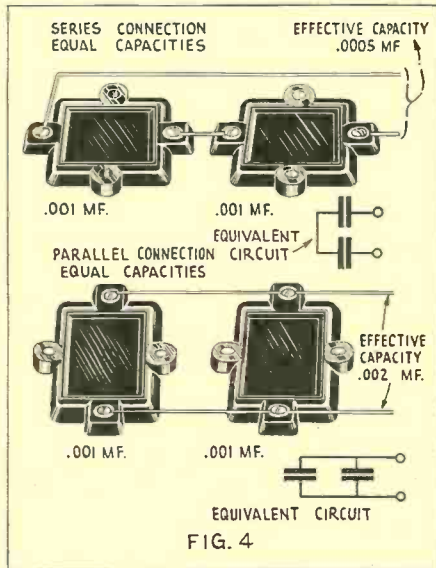

If the condensers are all of the same size, to get the combination in series just divide the capacity of one by the number used. If they are in parallel, of course, multiply.

Don't Guess!

Radio success or failure is largely a matter of knowing or guessing. And where all factors—voltage, tubes, circuits, etc.—are not precisely measured, you are *guessing* unless you supply hand-fitted resistance.



CLAROSTATS take the guess out of radio. The Grid Leak Clarostat is typical. It provides the precise grid leak value for best results, particularly in short-wave reception.

And in obtaining correct resistance values for grid-biasing and plate voltages, the Duplex Clarostat is a great favorite. It has two resistances, with center tap, each adjustable by means of ordinary screwdriver blade.



There are many other types of Clarostats for every conceivable radio purpose, in many designs, mounting, and resistance ranges.

WRITE for literature describing the complete Clarostat line and how to better your radio set. Better still, send 25c. in stamps or coin for "The Gateway to Better Radio"

CLAROSTAT MFG. CO., INC.
281 N. 6th St. Brooklyn, N. Y.

CLAROSTAT

Wholesale Prices

Tremendous stock and sales volume, with rapid turn-over to the thousands of radio dealers we serve enables us to make you worthwhile savings at lowest wholesale prices. Write for latest, new illustrated Catalog "B-4"

Allied Radio CORPORATION

711 W. LAKE STREET, CHICAGO

More "A" Power For Less Money!

With the Set Builders discount card you can purchase a **KNAPP "A" POWER KIT** at a liberal discount.

Write me today for full details telling about this new money-saving plan for set builders.

DAVID W. KNAPP, Pres.
Knapp Electric, Inc.
Division of P. R. Mallory & Co., Inc.
Room 417a, 350 Madison Ave., N. Y. C.

NEWS to Set Builders

Barawik offers set builders bigger bargains — bigger opportunities to make money this season. New sets, new kit ideas, all the leading parts, dynamic speakers, supplies, etc. Lowest rock-bottom prices. Bigger stocks, quicker service. Send for Big Bargain Book today—free.

BARAWIK CO., CHICAGO, U. S. A.

Mail This Coupon Now! For Free Copy

Name

Address

Please say you saw it in RADIO NEWS

THE NEW 5000 HOUR ELKON METALLIC RECTIFIER FOR "B" ELIMINATORS

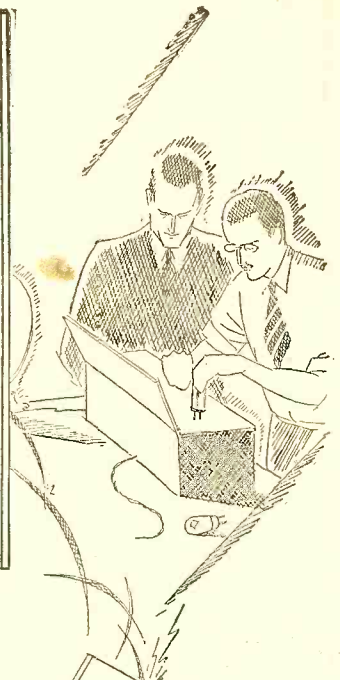
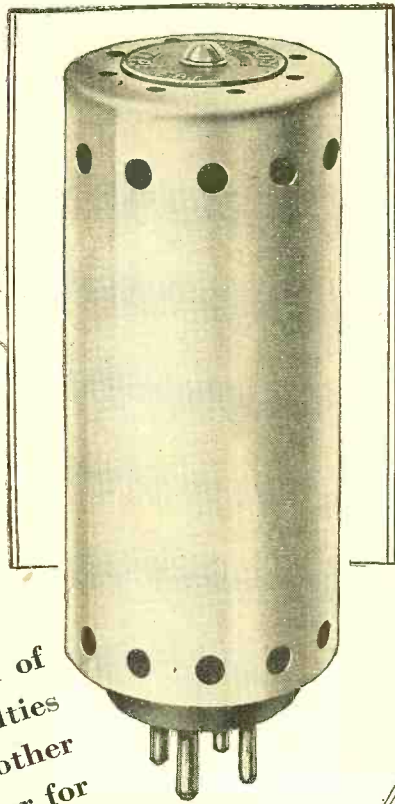

At last a dry high-voltage rectifier! All of the advantages of a tube—none of its frailties—much longer life—more efficient—smoother power—no noise—now as perfect a rectifier for the "B" end as the Elkon "A" Rectifier—stand-ard with "A" Eliminator manufacturers. And the Elkon Rectifiers are Self-Healing—line surges or accidental overloads are automatically taken care of—no permanent injury is done.

The Elkon EBH replaces BH type tubes in "B" Eliminators. Simply take out the fragile 1000 hour tube and plug in the husky Elkon EBH 5000 hour Rectifier. Same characteristics, but what an improvement.

Use the Elkon EBH Rectifier! Eliminate all uncertainty of life, of successful operation. Build your own new "B" Eliminator or convert the one you have to up-to-the-minute radio efficiency.

Radio Department
ELKON, Inc.
Division of P. R. Mallory & Co., Inc.
350 Madison Avenue, N. Y. C.

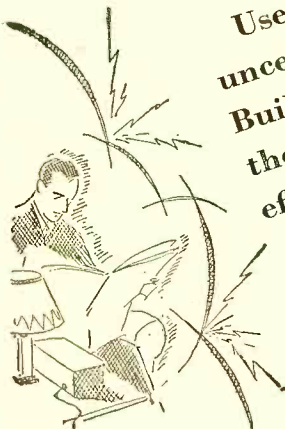
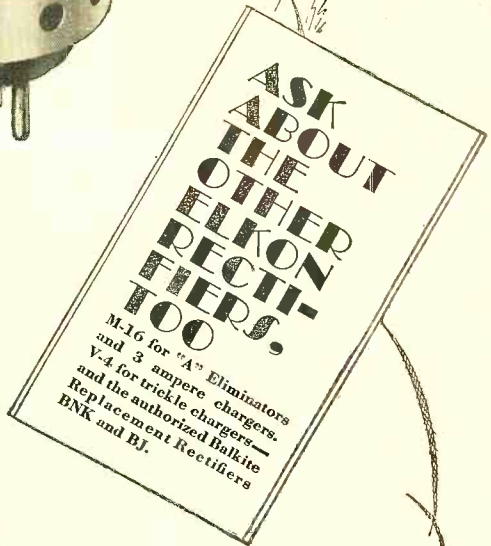

ELKON, Inc., Dept. E-27
350 Madison Avenue, N. Y. C.
Kindly send me complete information on Elkon Quality Radio Products.
Name
Address

Please say you saw it in RADIO NEWS

If it's "HAMMARLUND"

It's BETTER!

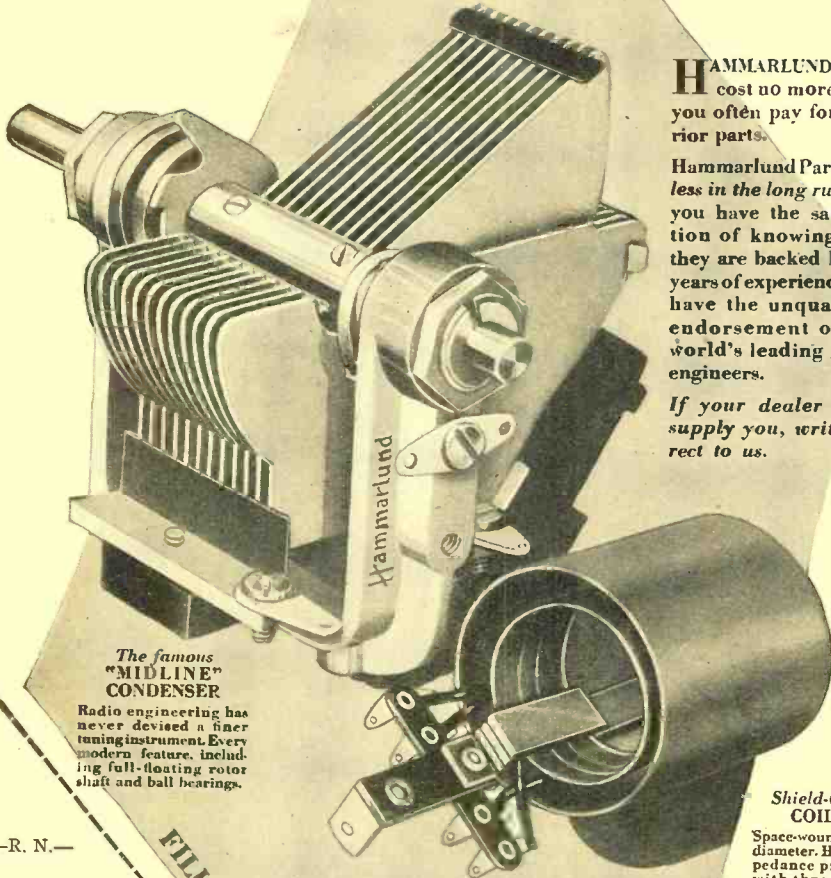

The famous "MIDLINE" CONDENSER
Radio engineering has never devised a finer tuning instrument. Every modern feature, including full-floating rotor shaft and ball bearings.

HAMMARLUND Parts cost no more than you often pay for inferior parts.

Hammarlund Parts cost less in the long run and you have the satisfaction of knowing that they are backed by 17 years of experience and have the unqualified endorsement of the world's leading radio engineers.

If your dealer can't supply you, write direct to us.

Shield-Grid COILS

Space-wound, 2" in diameter. High impedance primary with three taps. Specially designed for shield-grid tubes.

obtained by that of the combination. Five condensers of the same size in parallel have five times the capacity of one; five condensers of the same size in series have one-fifth of the capacity of one. Their resistance to voltage breakdown, of course, is made much higher in series connection.

The rule for obtaining the capacity of a combination of condensers of unequal size when wired in series is one which has made many a would-be mathematician grit his teeth and break his pencil. We will not give it, but merely a table by which the approximate capacity of almost any desired combination may be determined at once. The beginner for whom this article was written is invited to make a note of it for the benefit of his expert friend when the latter is wrestling with a condenser combination.

To use Table A, herewith, merely pick out the condensers which it is proposed to use, and write down the number opposite each capacity in the column of reciprocals at its right. Add the reciprocals; look for the number nearest to that sum in the column of reciprocals, and read the capacity opposite, at the left. The result will be near enough for practical purposes.

Example: We wish the capacity which is obtained by putting a .002-mf., a .0025-mf., and a .003-mf. condenser in series. The reciprocals are respectively 500, 400, and 333; the sum of the reciprocals is 1,233. The figure nearest to this in the column of reciprocals is 1,250, opposite .0008-mf. in the column of capacities. This is near enough for all practical purposes; particularly as commercial condensers are allowed a slight margin of "tolerance" or difference from their rated capacity.

Table A

Capacity mf.	Reciprocal	Capacity mf.	Reciprocal
.00001	100,000	.0008	1,250
.000012	83,330	.0009	1,110
.000015	66,670	.001	1,000
.000017	58,820	.00125	800
.00002	50,000	.0015	670
.000025	40,000	.00175	570
.00003	33,330	.002	500
.000035	28,570	.0025	400
.00004	25,000	.003	333
.00005	20,000	.0035	286
.00006	16,670	.004	250
.000066	15,150	.005	200
.00007	14,280	.006	167
.000075	13,330	.0067	150
.00008	12,500	.007	143
.00009	11,110	.0075	133
.0001	10,000	.008	125
.00012	8,330	.009	111
.000125	8,000	.01	100
.00015	6,670	.0125	80
.000175	5,715	.015	67
.0002	5,000	.0175	57
.00025	4,000	.02	50
.0003	3,330	.03	33
.00035	2,860	.035	29
.0004	2,500	.05	20
.0005	2,000	.06	16
.0006	1,670	.08	13
.0007	1,430	.1	10
.00075	1,330	.2	5

For Better Radio
Hammarlund
PRECISION
PRODUCTS

HAMMARLUND MFG. CO. 424-438 W. 33rd. St. New York

—R. N.—

- Enclosed 25c. for "HiQ-29" Manual.
- Enclosed 10c. for Short-Wave Manual.
- Send other Hammarlund Literature.

Name.....

Street.....

City.....

State.....

FILL IN AND MAIL

SET BUILDERS Get this Book

Barawik, the first and oldest radio specialty house, offers you unusual service this year. Bigger stocks, quicker shipments, lower prices. Deal with an old established, reliable house. Get honest goods, honest service, honest prices. Barawik service makes you more money. Send now for big new Catalog showing lowest wholesale prices.

BARAWIK CO. 22L Canal Sta., CHICAGO, U. S. A.

Mail This Coupon Now for Free Radio Guide

Name.....

Address.....



Build it Right

This New Catalog of

YAXLEY

parts and accessories will help you. Yaxley products are used in vital places in many of the most prominent and successful sets on the market today. Send for the new catalog.

YAXLEY MFG. CO.

Dept. N-9 So. Clinton St., Chicago, Ill.



Value of Tube Capacity

THE capacity between the grid and plate of a 201A-type tube is about nine micromicrofarads (.000009-mf.), and it is through such a small capacity that feedback and oscillation may occur. That of the 199-type tube is about 4 mmf.; while that of the screen-grid 222-type is only one-quarter of a micromicrofarad. It is for this reason that the screen-grid tube is increasingly in favor with short-wave experimenters.

Insure your copy reaching you each month. Subscribe to Radio News—\$2.50 a year. Experimenter Publishing Co., 230 Fifth Avenue, N. Y. C.

Please say you saw it in RADIO NEWS

RADIO'S - GREATEST - BARGAINS

On this page are listed some of the foremost bargains in radio merchandise ever offered. Tremendous savings on reliable products. Send us your name and address for big, FREE monthly bulletin of radio specials.

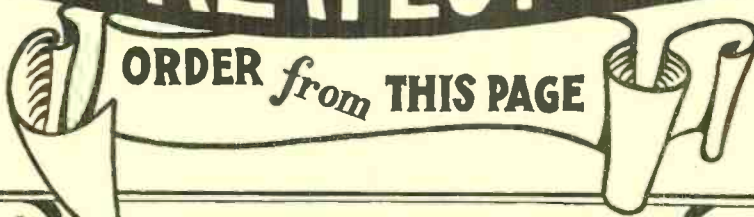

Let this page be your buying guide. We assure you that you can get no better bargains anywhere. Order from this page today--Send either 25% of the total purchase price if C. O. D. shipment is desired, pay on delivery, or remit in full with order.

RADAX

171 "B"
Eliminator
Kit Complete

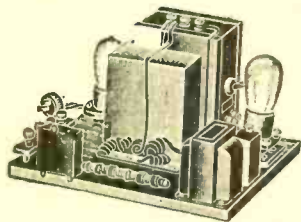

200 Volts. Can be assembled in ten minutes.

OUR PRICE
\$10.90

Bring Your Set Up-to-Date
NO RE-WIRING NECESSARY—JUST PLUG-IN
Use a SUPER "ABC"
Power Pack

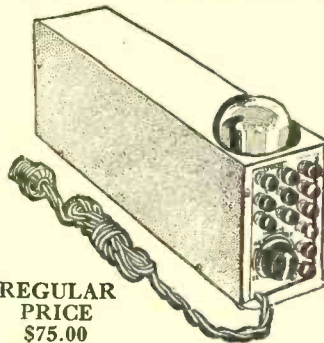

REGULAR PRICE
\$75.00

OUR PRICE
\$34.80

Simply place a 210 or 250 Power Tube in the last stage of your receiver. Then, note the tremendous improvement in volume and tone. The power pack delivers 450 volts and supplies the necessary filament voltage for your 210 or 250 tube. Does away with "B" batteries completely.

660-171A

UNIPAC
"ABC" Push-Pull, Wired

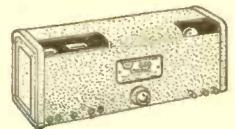

Using the following standard parts:

- 1—No. 245 Push-Pull
- 1—No. 246
- 1—No. 239 "A" Power
- 2—No. 244 Chokes
- Tobe "B" Blocks, etc.

OUR PRICE
\$29.50

S.M. 630 SHIELDED GRID 6-TUBE KITS

This is the finest kit manufactured by the Silver-Marshall Company. Only a limited number, so act quickly.



LIST PRICE
\$37.00

OUR PRICE
\$34.50

<p>BELDEN 5-STRAND WIRE FUSED CABLE An efficient, long-lasting battery cable of the highest quality. Prevents tube blowouts and damage to the receiver. Our Very Special Price 35c each List Price \$1.75 In Lots of 12 or more 30c each</p>	<p>PORTABLE PHONOGRAPHS Remarkable values in a well-known type of portable phonograph. List Price \$15.00 OUR PRICE \$4.90</p>	<p>CROSLY TILT TABLE SPEAKER A loud speaker, well-known for the fine quality of its reproduction. LIST PRICE \$35.00 OUR PRICE \$7.50</p>
<p>171 "B" BLOCKS \$3.75 210 "B" BLOCKS \$5.40 (GUARANTEED)</p>	<p>SUPER SHORT-WAVE ADAPTERS (WIRED) List Price \$45.00 Our Price \$18.50 FOR A.C. \$19.50</p>	<p>S. M. TRANSFORMERS Type List Type List No. 240—\$6.00 No. 244—\$5.00 No. 241— 5.00 No. 245— 7.00 No. 242— 7.00 No. 246— 7.00 No. 243— 5.00 50% off of the list price</p>

SEND 25% DEPOSIT OR REMITTANCE IN FULL
2% CASH DISCOUNT FOR FULL REMITTANCE

RAWNER RADIO AND TELEVISION COMPANY
142 Liberty Street, New York

Please say you saw it in RADIO NEWS

"You Can Forget the Condensers—If They Are DUBILIER'S"

**cr-r-rack
cr-r-rash!**

*Eliminate Interference with
one of these Devices*

The advent of partial and complete electrification of radio sets has brought about new problems resulting from the picking up of stray power line noises.

These scientifically designed interference eliminators will make your set operate as quietly as with batteries.

Types 1 (\$5.00) and 2 (\$7.50) are of condenser design; the No. 2 unit having double the No. 1 capacity.

Type 3 makes use of a specially designed filter net work. This unit because of its highly developed choke coil and shunt condenser system has wonderfully fine filter characteristics. Price \$15.00.

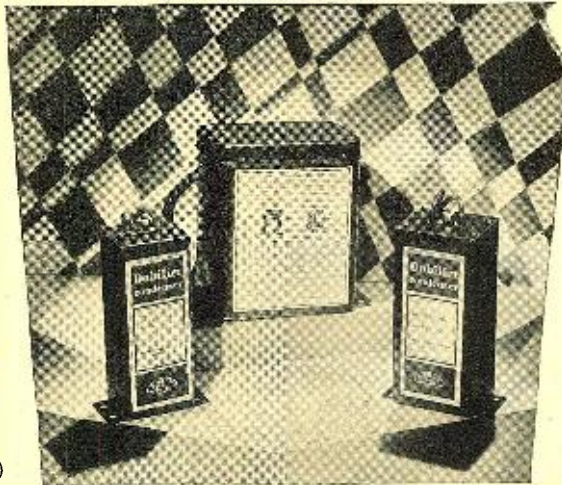

Dubilier Light Socket Aerial
"A Moulded Bakelite Product"

A simple device plugged into any light socket—does away with aerials and lightning arrestors. Will work on any set. No current consumed. If your dealer can't supply you, write to us direct. Price \$1.50.

Write to Dept. 12 for
free catalog



Dubilier
**CONDENSER
CORPORATION**

10 East 43rd Street

New York City

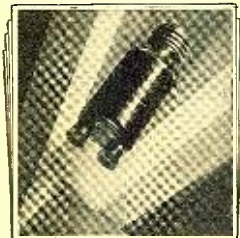

RADIO NEWS FREE BLUEPRINTS Nos. 73, 74 and 75



To encourage the construction of radio apparatus illustrated in this magazine, and make it easier for our readers, RADIO NEWS makes up each month large blueprints of the diagrams which accompany the principal constructional articles; these sets include full-sized drilling templates, coil data, etc., where required, and in each case a list of the apparatus originally used, with full specifications. Several thousand of these have been distributed each month.

If you desire a set of blueprints for any or all of the apparatus described in this month's Free Blueprint articles, fill out the enclosed coupon as directed and send it in. The blueprints requested will be mailed to you without charge, postpaid. We cannot send blueprints with magazines, or accept indefinite requests for blueprints to be issued in the future. Delay will be caused by failure to use this form, as this publishing office has many departments.

Blueprint Department, RADIO NEWS:
230 Fifth Avenue, New York, N. Y. (U. S. A.)

(C)

I intend to construct the following apparatus described in RADIO NEWS for February, 1929. Please send me a free set of large blueprints for each of the items checked.

- No. 73. The "Copperclad Special" Short-Wave Receiver.
- No. 74. A "250" Power Amplifier and Pack.
- No. 75. A Modulated Oscillator.

Name

Street Number

Postoffice

State (Province, etc.)

(Please typewrite your name and address or print it with a pen—not a pencil—as many signatures cannot be read. This will avoid errors in addressing the mail.)

Please say you saw it in RADIO NEWS

Radio Wrinkles

(Continued from page 748)

least, could not hurt the already-crushed cone. Taking the diaphragms from the framework, he straightened them out as well as possible and then smeared over the crushed places a coating of a well-known household cement, allowing this to dry thoroughly. When dry this cement is like celluloid and this elasticity was imparted to the damaged diaphragms; so that now they are back in use and as good as new.—Contributed by Clinton A. Anderson.

Our readers are invited to contribute ideas. A year's subscription to RADIO NEWS will be given in compensation for each accepted item. If the author of the wrinkle is already a subscriber, his subscription will be extended one year or he may accept a one year's subscription to SCIENCE AND INVENTION or AMAZING STORIES, both published by the Experimenter Publishing Co.

IMPORTANT, IF TRUE

America is discarding the use of the word "loud speaker" in connection with radio, the correct word now being "enunciator." It is rumored that they are reserving the term "loud speaker" for domestic uses.—Popular Wireless, London.

The latest name in America for a wireless listener is a "shut-in." A little extension to this new name and we shall have a night's listening-in described as being shut-in till shut-up at shut-down.—Wireless Magazine, London.



In Our
February Issue:

The Captured Cross-Section, by Miles J. Breuer, M.D. In this story, the scientist not only does a lot of interesting figuring, but he actually introduces an entirely new method to supplement his figures, which seems quite plausible; and in the story, at least, proves very effective. Dr. Breuer knows what he wants to say and knows how to say it. He keeps the reader in complete absorption and anxious suspense to the very end.

The Sixth Glacier, by Marius. (Part II.) In the concluding chapters, the author continues his story in the same engrossing manner, about the further devastations caused by the fast oncoming glaciers, while the earth still moves in the frigid region of space. Why and how the world is finally rehabilitated is well told in gripping detail.

Phagocytes, by A. H. Johnson. Until comparatively recently, or more specifically, until William Harvey, the scientist, discovered it, we knew nothing about blood circulation. This story deals with this subject in such a manner that you get 99% information in a most delectable manner. Perhaps there will be more stories telling us what is going on in the great mysterious machine we call "The Human Body." We recommend this unusual "story" heartily.

Mernos, by Henry James. Seven new planets were discovered in 1928; Professor Pickering is supposed to have found an extra-Neptunian planet far beyond the orbit of Neptune, and he gives its diameter, its mass and its orbit, though it has not been seen in the telescope. "Mernos" is a charming interplanetary extravaganza about a new—thus far undiscovered—planet, which will delight the reader.

And others.

\$62.50 Buys This

MARVELOUS 8 TUBE ALL ELECTRIC

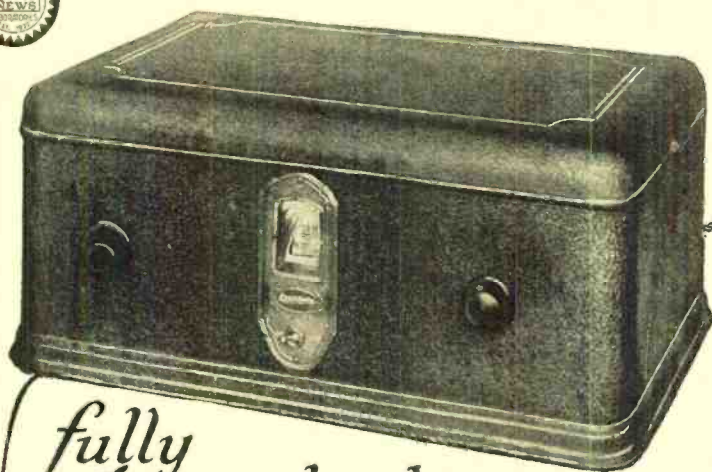

RADIO
Complete With
SPEAKER
and
8 TUBES

fully guaranteed

You Get the Dealer's Profit!

This is the MEL-O-RAD humanized tone, 19 inches high MAGNETIC CONE SPEAKER matched to every receiver.

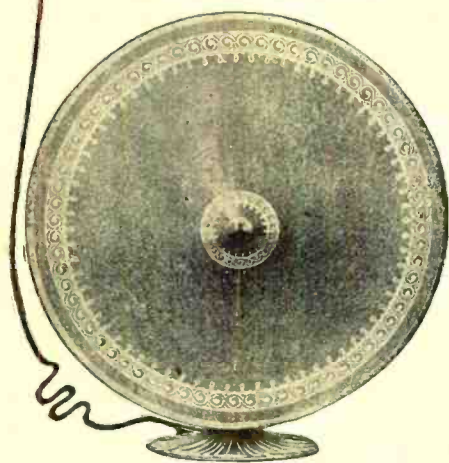

A radio set manufacturer, a tube maker, and a producer of cone speakers, all well and favorably known throughout the industry for the quality and efficiency of their products, have combined to make it possible for everyone everywhere to own an electric radio. They have organized their own selling agency, eliminating distributors, jobbers and dealers, and pass the savings along to the public.

The result is the most phenomenal offer ever made in the history of radio—an 8 tube all electric, one dial control radio with all necessary tubes and a life-like reproducing magnetic cone speaker complete with nothing else to buy, ready to plug in and operate, for only \$62.50, less than the regular retail dealer's price for a radio set alone, and—the entire outfit is absolutely guaranteed.

Set, Tubes and Speaker Matched for Perfect Performance.

Before shipment, each and every tube is thoroughly tested and matched for the set in which they are to be used. The same test is given to the magnetic cone speaker, so that the complete outfit, the set, the tubes and the speaker are scientifically matched for the most perfect reproduction of voice and music.

The receiver itself is a thing of beauty, size 19½ by 12½ by 18½ inches, housed in a most attractive Aquatex metal cabinet which harmonizes with the furnishings of any home. One illuminated dial simplifies operation and brings in station after station, clearly, distinctly and with all the volume desired.

Satisfaction Guaranteed or Money Refunded.

Take advantage of this unusual radio offer now. Send us your check or money order and complete outfit will be shipped to you ready for immediate operation. There is nothing else you need to buy. Everything you need is included at our more than 50% off list price offer.

Simply plug into your electric light socket, turn on the switch and you will hear a most perfect radio performance. Order your Melorad Radio Outfit today, and if after two weeks you are not perfectly satisfied, just say so and your money will be cheerfully refunded.

Here's What You Get.

- One Melorad 8-tube All Electric Radio Receiver with Phonograph Pick-up, Regular Retail Price \$ 75.00
- Eight Guaranteed Tubes as follows: Five 226-A-C, One 227 A-C, One 171-A and One 280, Regular Retail Price 24.50
- One Magnetic Cone Speaker, Height 19 Inches, Regular Retail Price 25.00
- One Complete Aerial Kit, including Approved Lightning Arrester.. 2.50
- Total Regular Retail Selling Price..... \$127.00
- Our Direct from Factory to Public Price..... \$ 62.50
- You Save (MORE THAN 50 per cent)..... \$ 64.50

Mail This Coupon Order Now

Artee Radio Sales & Mfg. Corp.,
 206 Broadway, New York City, N. Y.

Enclosed find money order for \$62.50, for which please ship me one 8-tube All Electric Melorad Radio Receiver complete with all necessary tubes and magnetic cone speaker. It is understood that if after two weeks trial I am not perfectly satisfied, I may return the outfit and my money will be refunded.

Name

Street No.

Town and State.....

If you desire further particulars check here

Artee Radio Sales & Mfg. Corp.,
 206 Broadway, New York, N.Y.

Please say you saw it in RADIO NEWS

BENJAMIN

Cle-Ra-Tone Radio Sockets

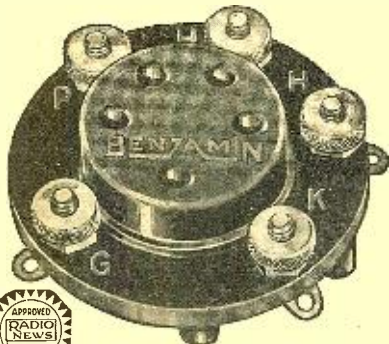

Specially Designed
for

A. C. Detector Tubes

Spring supported, shock absorbing. The tube-holding element "floats" on perfectly balanced springs. Reduces microphonic disturbances, tends to lengthen life of tube, and lessens the possibility of short-circuiting closely-spaced tube elements.

Y-Type, Green Top, for 5 Prong A. C. Tubes: for mounting on top of panel, \$1.00; for direct attachment to panel, 75c.

Red Top, for Standard UX Type Tubes: For mounting on top of panel, 75c.; for direct attachment to panel, 50c.

At all Radio and Electrical
Dealers and Jobbers

Benjamin Electric Mfg. Co.

120-128 S. Sangamon Street
Chicago

New York
247 W. 17th St.

San Francisco
448 Bryant St.

NEWS to Set Builders



Barawik offers set builders bigger bargains — bigger opportunities to make money this season. New sets, new kit ideas, all the leading parts, dynamic speakers, supplies, etc. Lowest rock-bottom prices. Bigger stocks, quicker service. Send for Big Barawik Book today—free.

BARAWIK CO., 22D Canal Sta., CHICAGO, U. S. A.

Mail This Coupon Now! For Free Copy

Name

Address

Quality Apparatus

Our latest bulletin No. 229 describing our complete line of quality apparatus is yours for the asking. Write for it today.

GENERAL RADIO CO.

30 State St., Cambridge, Mass.

Outdoor and Indoor Aerials

(Continued from page 729)

thousandth of a volt. A test made on the three-kilowatt broadcaster in Rome, Italy, 880 miles away, resulted in a reading of three one-thousandths of a volt.

ADVANTAGES OF THE LOOP

The great advantage of the loop is its ability to determine the direction of the station being received, and also to cut out strong transmitting stations in slightly different directions. We conclude, therefore, that a loop has much better selectivity than an ordinary aerial. Especially important for distant reception is the greater freedom from interference of the loop as compared with the outdoor aerial; if we presume that the sources of disturbance are equally divided over the receiving locality, it follows that the interference for a loop antenna is only 64 per cent. of that encountered with an outdoor aerial.

"B" Battery By-Products

(Continued from page 749)

of bakelite and push the wires from a pair of carbons up through them and attach to a pair of the spring clips. Place the insulating strip across the top of a glass of water, so that the carbons are completely immersed, and then connect the electric-light wires to the clips. In a few minutes the water will be heated warm enough for shaving.

Many other uses can, of course, be found for the metallic parts, but these few will well repay for their salvaging. The nuts will fit other bolts than those from the battery; they can be used for shims, for thick washers and a number of purposes. The washers also can be used for shims, a piece can be cut out of them to turn them into fork terminals for flexible wires, and they can of course be used for their intended purpose.

When all the good material has been reclaimed and you have nothing but the old zinc cells, they can be turned to good account by throwing a handful into the fire now and then. The chemical action works wonders in cleaning the flues and chimney of soot. Half a dozen cells a week will be enough. Throw them into a fairly hot fire; the fumes will instantly curl up into the firebox and you can even see the soot drop off by looking in the fire-door.

So don't throw away your next dead battery until you make some effort to reclaim its latent value. This takes only a few moments and will help to balance the red side of the ledger.

THEY HAD A START

Mrs. BANGS (confidentially): "Yes, we bought this radio set on installments last winter."

Mrs. BINGS (with some curiosity): "I suppose you've got it most paid for, then?"

Mrs. BANGS (hesitatingly): "Well—about as far as the second tube."—Leo Hostensky.

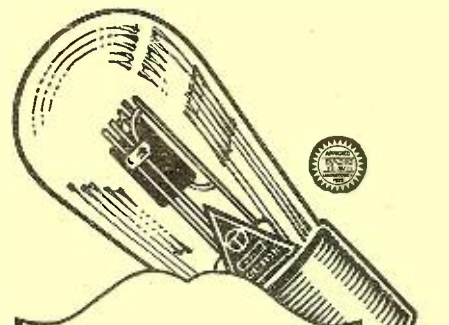

The only tubes with the exclusive Televocal Support. Greater sensitivity. Longer life. Made in all standard types. Ask for them at your dealers.

Televocal Corporation

Televocal Building
Dept. A-7
588—12th Street
West New York, N. J.

Televocal

Quality Tubes

M&H

Radio's largest
kit supply house

ESTABLISHED 30 YEARS

We Have Complete Kits FOR ALL CIRCUITS

Now appearing or which have appeared in "Radio News" and other publications.

Dealers and professionals Set Builders, write for our

NEW WHOLESALE CATALOG

Hi-Q 29 Kits in Stock

Silver Marshall Kits

National and Aero Short Wave Kits

Convert your present set to the low-wave bands.

Amertran Power Equipment

Write for **FREE BLUE PRINT** for the new 250 push-pull power amplifier.

M. & H. Sporting Goods Co.
512 Market St., Phila., Pa.

Don't Miss
AMAZING STORIES

"The magazine of scientific adventure, excitement and romance"

At All Newsstands

Please say you saw it in RADIO NEWS

WHOLESALE PRICES

for Dealers, Community Set Builders, General Repairmen and Agents!

NEW ISSUE!
JUST OFF THE PRESS!

BIG PRICE CUTS

New 75 HOOKUPS
1500 ILLUSTRATIONS



Our new, HUGE 260 PAGE WHOLESALE CATALOG No. 19 enjoys the enviable distinction of being universally accepted by the RADIO TRADE in the same manner that a school treasures the Dictionary and Encyclopedia Britannica—or the home the Bible and Almanac!!

The preparation and distribution of this MAMMOTH Catalog COSTS A TREMENDOUS SUM—the huge volume of business derived from it warrants this cost as well as the genuine pleasure it gives us to know that those “in the know” regard our catalog AS THE OFFICIAL ORGAN OF THE 1929 RADIO SEASON!!!

This FREE CATALOG is literally a most valuable ENCYCLOPEDIA—YOU cannot well afford to be without one—and, you do not have to. Your request for one is all that is needed! A day or two later, it is in your possession. Surely, a TEST OF OUR PROMPTNESS PLEDGE!

And we are right on the job, ready to supply television apparatus, too! We list more such parts than appear in any other Radio Catalog.

Those having No. 18 Catalog should immediately send for No. 19. ALL PRICES HAVE BEEN REDUCED TREMENDOUSLY!

We can supply any parts and kits described in this issue.

Send for prices at once!

THIS 260-PAGE RADIO CATALOGUE FREE

BUY from Radio's Oldest Mail Order House!

In these many years we have been in the Radio Mail Order Business, we have learned from EXPERIENCE how such an organization must be efficiently run in order to GAIN AND RETAIN THE GOOD WILL OF OUR CUSTOMERS. In this, our DETERMINED GOAL, RADIO SPECIALTY COMPANY OFFERS TO SHIP ALL ORDERS IN FROM 6 TO 24 HOURS—OFFERS YOU 100% QUALITY MERCHANDISE ON A STRICT MONEY-BACK BASIS IF NOT THOROUGHLY SATISFIED—AND OFFERS YOU ALL MERCHANDISE AT ABSOLUTE ROCK BOTTOM NET PRICES! Our employees—our executives, are all pledged to handle your every order and inquiry in an intelligent manner. Our 24-HOUR SHIPMENT SCHEDULE MUST BE UNRESERVEDLY MAINTAINED! And to this pledge, we owe our daily increasing patronage. It will pay YOU to be numbered among our many thousands of customers! A trial is all we ask!

"RASCO" has it

And, if we do not list in our catalog your Radio requirements, WE WILL OBTAIN SUCH PARTS, BILLING YOU AT THE USUAL TRADE DISCOUNTS!

OUR CATALOGUE CONTAINS THE LARGEST ASSORTMENT OF RADIO MERCHANDISE IN THE COUNTRY. Only the most successful manufacturers' products are listed—such lines as PILOT—SILVER—MARSHALL—CARTER—AERO—YANLEY—TOBE—HAMMARLUND—AMETRAN—CUNNINGHAM—DONGAN—THORDARSON—MUTER, etc., etc. THE LATEST IMPROVEMENTS IN RADIO ARE LISTED AND THOROUGHLY DESCRIBED IN THIS GREAT CATALOG: A.C. ALL ELECTRIC Sets with self-contained ABC power supply—Public Address Amplifier systems—A.C. Set Converters—A and B eliminators—Dynamic Speakers and Units—Magnetic Speaker Chasses—250 Tube Amplifiers—Airplane Cloth Speakers—Push-Pull Power Amplifiers—Electric Phonograph Turn-Tables—Combination Radio and Electric Phonograph Consoles—Speaker Tables—Short Wave Sets and Adapters—Shield Grid Tube Kits—Television Parts. LOGICALLY, HOW CAN YOU AFFORD TO BE WITHOUT OUR CATALOG—SEND FOR ONE NOW!



Radio Specialty Co.



98W PARK PLACE, NEW YORK

Please say you saw it in RADIO NEWS

For More Accurate Voltage Control

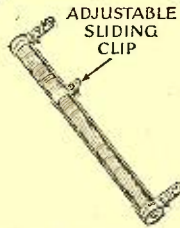

U. S. Patent 1,676,869 and Patents Pending

TRUVOLT ALL-WIRE RESISTANCES

THE ingenious method of winding a much greater quantity of larger resistance wire of comparatively low resistance into a small space assures a finer regulation of voltage and far greater current-carrying capacity. Truvolt Variables simplify B-Eliminator construction by eliminating difficult calculation and making all adjustments easy. 22 stock sizes \$3.50 each.

Truvolt Fixed Resistances are adjustable to different set values by the use of sliding clip taps — an exclusive Truvolt feature! Made in all desirable values and circuit ratings. Electrad specializes in a full line of Controls for all Radio Purposes including Television. Write for Free Circulars and Full Information.

Dept. N-2, 175 Varick St. New York

ELECTRAD

FRESHMAN
YOUR ULTIMATE RADIO
AT ALL
AUTHORIZED
DEALERS



GEARS—All Kinds—Small

The most accurate made and prices reasonable. We carry a complete line of gears in stock for immediate shipment. Can also quote on special gears of all kinds. Send us your inquiries.

Write for Catalog 40
Chicago Stock Gear Works
105 So. Jefferson St., Chicago

A Modulated Oscillator

(Continued from page 745)

current call book, for the wavelength, the frequency equivalent may be obtained.

Now, without moving the dial of the detector tuning condenser, rotate the dial of the oscillator. As resonance is approached it will be seen that the needle of the meter begins to fall back and then, after resonance is passed, the needle resumes its former steady position. By moving the hinged coil away from the secondary coil a lesser degree of coupling is obtained which results in a more sharply-defined, but lessened, dip in the meter needle. At this point the oscillator is in resonance with the regenerative detector, whose wavelength setting is known to be that of the station received; a notation indicating the setting of the oscillator dial for that particular wavelength should be made. By moving down on the detector tuning dial, other stations can be picked up and the radio oscillator brought into resonance with the detector circuit for each position. In this way a number of points may be obtained which, when plotted on cross-section paper, will result in a tuning curve.

When calibrating the short-wave coils, those who know how to do so can pick out the harmonics of stations operating in the broadcast range and so obtain a number of calibration points. Otherwise, it is necessary to identify short-wave stations on a receiver and follow the same procedure as above.

To operate the oscillator it is necessary merely to turn on the switch for either the radio (SW1) or the audio (SW2) section (or both, if it is to be used as a combination oscillator) and then with the rheostat (R2) adjust the response to a desired value. Then, if it is desired to determine the tuning range of a coil-condenser combination in a receiver, merely couple it closely to the oscillator; set the test circuit at maximum and rotate the oscillator dial. Not only will resonance be indicated by the grid meter but also, if a pair of phones are attached to the receiver being tested, a modulated carrier will be heard. Then the same procedure may be followed at the minimum setting of the receiver dial. When it is desired to regulate the amount of audio tone, the variable resistor (R4) shunting the output jack may be adjusted to the desired setting.

IN TWO ACTS

CUSTOMER: "One screen-grid tube, please; what's the damage?"

SALESMAN: "Five dollars, sir."

* * *

CUSTOMER (next evening): "This tube gave a flash when I connected up the batteries, and that was all. Will you test it? What's the damage?"

SALESMAN: "Five dollars, sir."—Translated from Popular Radio Weekly, Australia.

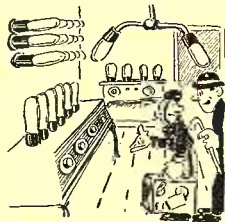

SUPPOSE IT HAD BEEN 250!

HOTEL CLERK (to guest) "Your room, sir, is No. 210."

GUEST (A radio enthusiast): "Gee whiz! That must be the power room."—Thomas Sloan.

Make Your Set a Modern A. C. Power Receiver

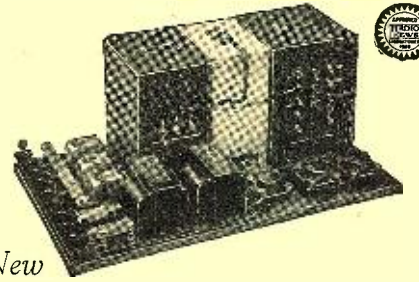

New

AMPLIPACK

A Complete A. C. Power Supply—"A" and "B" and "C"—Makes any D. C. Set into an Ultra-Modern A. C. Receiver. Uses two 210 type tubes in Push-pull; or one of the new 250 type tubes. Power Amplification gives perfect reproduction over the entire musical scale range.

QUICKLY ASSEMBLED

You can assemble an AmpliPack easily in one evening. We supply complete layout diagrams. Simple to install. Attached to set in three minutes. Consumes no more current than an ordinary 50-watt light. Cool, quiet, dependable.

ASK YOUR DEALER

Leading dealers can give you full details and our simple assembly diagrams. Don't be satisfied with out-of-date reception—build an AmpliPack tonight!

FREE Booklet

Write for our new Free Booklet—the latest word on Power Amplification and A. C. Conversion.

TRANSFORMER CORP. OF AMERICA

1428-1432 Orleans Street, Chicago, Ill.
Manufacturers of the T. C. A. Line of Power Transformers, Audio Transformers, Chokes, Power Packs and Power Amplifier Packs.

STOP! LOOK! LISTEN!



STOP—Have you properly shielded 222-322 tubes?

LOOK—At the Carter Tube Shield.

LISTEN—It completely shields. Connector, Cap, and fourth element lead are provided. A Carter Tube Shield

completely shields and gives you the full value of the greater amplification these tubes give when properly shielded. Stocked by jobbers and dealers everywhere.

CARTER RADIO CO.
300 S. Racine Ave., Chicago, Ill.



"The Majority's Choice"

REAL JOBS OPEN Now in ELECTRICITY

90 days fits you for big pay ELECTRICAL job at \$50 to \$200 a week. All practical work on real equipment. MONEY-BACK GUARANTEE. Free Radio Course. Write for 60-page FREE BOOK, and remarkable tuition offer. McSweeney Electrical School, Dept. 76-X, Cleveland, Ohio

Please say you saw it in RADIO NEWS

A Flexible 9-Tube Super

(Continued from page 747)

constructor is free to follow his own choice of amplification. As mentioned before, straight transformer-coupled amplification is used in the audio system of the receiver described here. At the output of the last audio tube, which is of the power-amplifier type, is a filter system comprising a 30-henry choke coil and a 4-mf. filter condenser C5; these components are absolutely necessary when using present-day power tubes to protect the coils of the loud speaker from the heavy current of the tube. C4 is a 1-mf. by-pass condenser, which function it serves in its present position.

USE OF FILAMENT BALLASTS

When constructing this receiver it should be remembered that the use of rheostats as shown in the diagram does not necessarily mean that filament-ballast resistors cannot be used. They may be substituted for the rheostats as follows: a ¼-ampere ballast in the filament-lighting circuit of the first-detector tube V1—the rheostat R1 is then wired to control only the oscillator tube and, for this purpose, should have a resistance of 20 ohms. As shown here, R1 controls with 10 ohms both first-detector and oscillator filaments. Rheostat R2, as shown, is a 6-ohm rheostat controlling the four I.F. tubes; it may be replaced with a 1-ampere filament ballast resistor. In the event the latter cannot be obtained, two ½-ampere resistors may be wired in parallel to give the desired resistance. The second detector V7 is controlled by rheostat R3, which has a resistance of 20 ohms; in this case a ¼-ampere resistor will serve the purpose. In arranging the filament wiring of the audio tubes, no single control can be used for simultaneous operation of both tubes; this is due to the switching arrangements brought about by the jack-switch, SW2. Therefore, rheostats R4 and R5 (controlling the first and second A.F. tubes, respectively) have values of 20 ohms each, and are replaceable by ¼-ampere resistors.

It will be noticed that the potentiometer R6 is not connected directly across the "A" battery, as usually the case, but is connected from "A+" to the negative filament lead of the I.F. tubes. Thus, when these tubes are switched out of the circuit for local reception by means of the jack-switch SW1, there is no leakage of "A" battery current through the potentiometer. Also, this gives the potentiometer a range from zero to about four or five volts, depending on the value of the rheostat R2; and the intermediate amplifiers may be brought into oscillation when the potentiometer is turned up to about three-fourths of its maximum range.

The front view of the receiver (page 746) shows the panel layout to be both neat and decorative. In the center are the double drum-dials; at the left of the dials, on the horizontal center-line of the panel, is a small knob operating the tickler coil of the antenna tuner L1; at the same distance to their right is a similar control knob operating the potentiometer R6. Above and at the right of the tickler knob is the double-circuit jack J, for plugging in the loop when desired. About half-way between the tickler knob and the left end of the panel, and somewhat below the center-line,

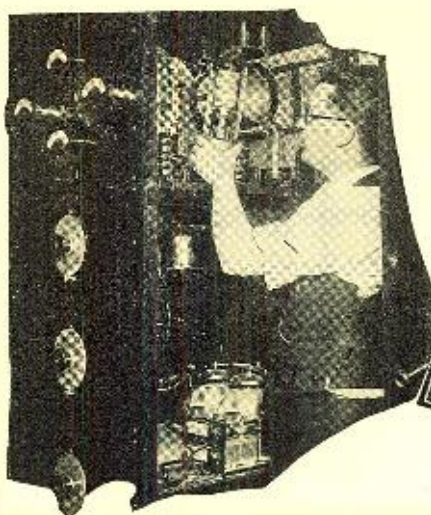

FREE RADIO BOOK~ describes many opportunities to make big money in the Radio field.

Here's a book that's shown man after man the way to "cash in" on the big opportunities in Radio. I'm not asking \$5 or \$6 for this book—it's FREE. If you're earning a penny less than \$50 a week clip the coupon below and get a copy of this free Radio book for yourself.

Salaries of \$50 All the Way Up to \$250 Weekly Not Unusual

Radio—the NEW, speedy, growing, live-wire profession—needs trained men for its good jobs. Television, trans-Atlantic Radio telephony, many other wonderful inventions and developments are being made constantly in this field! Each one means more big-money opportunities for a trained Radio man. My book gives the facts about these Radio opportunities. And more—it tells how you can get all the training in Radio you need, quickly and easily in your spare hours at home, by my new and practical methods. In a short time you, too, as have hundreds of others, can be prepared to take advantage of these big-money Radio opportunities—salaries of \$50 all the way up to \$250 a week not unusual. My Free Book will give you all the Facts and Proof.

Extra Dollars for You Almost At Once

Think of making \$15, \$20, \$30 extra each week "on the side," without interfering with your regular job! I'll show you how to do that, too, by using spare time that you're wasting now. I'll show you how to turn what I'm teaching you into cash almost at once, when you and I get started together. My Free Book tells you all about it. If you send for the book today, and if you have the average man's ability, it's possible for you to be making extra money thirty days from now. And you'll be ready for a good full-time Radio position after eight to twelve months' of spare-time training.

I'll Send You this Big 64-Page Book FREE

My book is filled with photos and facts—the pay-raising facts you want to read. If you're interested in Radio, or if you're interested in making more money, you owe it to yourself to read this book. The book absolutely won't cost you a cent, and you place yourself under no obligation by sending for it. No previous Radio experience needed to take advantage of this offer. No special schooling required. Send coupon today.

**Address J. E. SMITH, President
National Radio Institute, Dept. 9NTT, Washington, D. C.**

**J. E. SMITH, President,
National Radio Institute,
Dept. 9NTT, Washington, D. C.**

Dear Mr. Smith: Kindly send me your free 64-page Radio book, with all information about learning Radio for bigger pay. I understand this places me under no obligation.

Name.....

Address.....

Town.....State.....

HUNDREDS OF MEN HAVE WON SUCCESS THIS WAY
The National Radio Institute is the oldest and largest Radio home-study school in the world. It has prepared hundreds of men for the Radio profession—some of them now holding leading positions in this industry. You'll find N.R.I.-trained men in practically every Radio organization of any importance throughout the world. The same practical tested training that enabled these men to get ahead is now open to you. And this training has been improved, enlarged greatly to keep up with the constant expansion of Radio opportunities.

Executive with Big Corporation
"Am now Secretary and Treasurer of big Hammel-Roberts organization. My success here and in my former position as Editor of Radio Home due to the splendid training I got from you."—Leslie G. Biles, 1182 Broadway, New York City. **Earns \$1000 by Spare Time Work**

"In spare time in the evening I have made about \$1000 since starting your course. I am going right ahead with the lessons and work hard, for Radio sure is a field of unlimited opportunity."—Deloss Brown, South St., Foxboro, Mass. **From Miner to Over \$5000 Yearly**

"Two years ago I enrolled for your training—a coal miner by trade. Now I'm manager for the entire state of Michigan for the National Lead Battery Co., salary \$3480, bonus \$350, and commission on sales that boosts it over \$5000. Your training gets all the credit."—Wm. H. Wilson, 1429 S. Michigan Ave., Chicago, Ill.

**Mail
coupon
Today!**

Please say you saw it in RADIO NEWS

Potter Condensers



**Quality
Long Life
Uniformity
Economy**

Used in the finest radio receiver to insure the operation and make a real musical instrument.

Potter T-2900 Condenser Block for the single 250 type tube amplifier—\$20.00.

Potter T-2950 Condenser Block for the push-pull 250 type tube amplifier—\$22.50.

Potter T-2098 Condenser Block for the single 210 type tube amplifier—\$20.00.

Potter T-280-171 Condenser Block for a power-pack with 280 type tube rectifier for a 171 type tube power tube—\$18.00.

Potter by-pass and filter condensers are available in all capacities and working voltages.

Potter Interference Eliminator



Your radio broadcast programs need no longer be spoiled by interference from oil burners, ice machine motors, vacuum cleaners, violet rays, etc. The remedy is to connect a Potter Interference Eliminator to the interfering device.

Code	Size	A. C. Supply Line Volts	Price
103-03	1" x2" x4 3/8"	110	\$2.25
104-04	1 3/8" x2 1/4" x4 3/8"	110	3.00
105-05	1 3/8" x2 1/4" x4 3/8"	110	3.75
303-03	1" x2" x4 3/8"	220	3.00
304-04	1 3/8" x2 1/4" x4 3/8"	220	3.50
305-05	2" x2 1/4" x4 3/8"	220	6.50

The Potter Co.
North Chicago, Illinois
A National Organization at Your Service

More Profits To Set Builders

One good radio idea may be worth millions. Barawik has thousands of ideas for radio set builders to make more money. Barawik's Big Radio Book will help you while elections are on and big national events stir the world.



Send for your copy today - NOW
BARAWIK CO. 226 Canal Station, CHICAGO, U. S. A.

Mail This Coupon Now! For Free Copy

Name

Address

Insure your copy reaching you each month. Subscribe to RADIO NEWS—\$2.50 a year. Experimenter Publishing Co., 230 Fifth Ave., N. Y. C.

is the jack-switch SW1, for switching the intermediate amplifier tubes in and out of the circuit. The other jack-switch, SW2, controlling the audio amplifier circuit, is in an exactly similar location at the right of the panel; to the right of this switch and slightly higher is the filament-switch SW3, controlling the entire set.

LAYOUT

The average "super" fan should be able to assemble this receiver from the information which can be obtained by studying the circuit diagram (Fig. 1), as well as the rear view of the set, which illustrates clearly the mounting of the various components on the rear of the front-panel and the sub-panel. Because of the weight of the sub-panel after all apparatus has been mounted, at least three sub-panel brackets should be used for support; those used in this assembly are of bakelite and measure 8 1/2 x 1 x 3/8 inches.

In the rear view, from right to left, we find, first, the oscillator coil with the oscillator socket directly at its left; and, continuing in this direction with the components nearest the front panel, we have the jack-switch SW1, the first-detector socket with its grid leak and condenser directly in front of it and, at the immediate left of the socket, the antenna coupler L1. Here it will be noticed that a piece of copper sheeting has been secured to the front panel directly in front of the antenna coupler, and a lead is run from the copper sheeting to the "A—" lead.

The metal escutcheon plate on the front panel also is used as a shield, by grounding it to the "A—" lead. At the left of the coupler is the double-circuit jack, J, which is used to give choice of loop or aerial operation. Close to the jack at the left are the tuning condensers C1-2 with their drum-dial controls. What appear to be three sockets in line at the left of the drum-dial are the three rheostats R3-4-5; these are mounted on the sub-panel because the filaments of the tubes they control require little variation after their point of best operation has been found.

On the panel, and above the rheostats, is the potentiometer R6; after which we return to the sub-panel and end the line with the jack-switch SW2, the output choke coil (which has its condenser C5 under the sub-panel); and, mounted on the front panel and directly above the output choke, the filament switch, SW3, which opens and closes the entire "A" battery circuit.

We will now retrace our descriptive steps and return to the extreme right of the sub-panel, so that we may "head west" again; this time the apparatus mounted nearest the rear of the sub-panel will be considered. The first items seen on this "route" are the rheostats R1-2 directly in front of the first-detector socket. At the immediate left of these resistors are the five intermediate-frequency transformers IF1-2-3-4-5, each with its tube socket directly behind it. On the extreme rear of the sub-panel and between IF1 and IF2 is the "Aerial" binding post; the "Ground" post is between IF2 and IF3. The two audio-frequency transformers with their respective tube sockets directly behind them, follow in line with the I.F. frequency transformers. Between the first A.F. transformer and the last I.F. transformer is the R.F. choke coil with its by-pass condenser C3 behind it. The line of battery binding-posts in front of the

EVERY SET Must Have a Radio Control Box for Safety



Centralab Radio Control Box List Price \$3.00

THIS is one accessory that is in demand by the owners of all socket-operated radio sets. Wide-spread comment by the radio press proves the necessity of a line voltage control or regulator to compensate for high line voltages found in every locality.

Centralab fully guarantees the Radio Control Box and advises its use on every socket-operated radio set.

Send for interesting booklet "Volume and Voltage Controls Their Use."



20 Keefe Avenue

Milwaukee, Wis.

ACTS IN 7 SECONDS

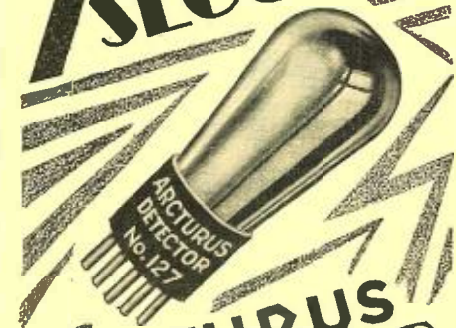

ARCTURUS DETECTOR TUBE

ARCTURUS A-C LONG LIFE TUBES

ARCTURUS RADIO CO. NEWARK, N.J.

CODE LESSONS FREE

In Your Home. With each instructor we furnish complete code instructions. Lessons recorded on waxed-tape records make everything simple and clear. Teleplex reproduces actual sending of expert operators. Sends you messages, radiograms, etc., just like an operator would. Endorsed by U. S. Navy and leading schools. Write for booklet NR.

TELEPLEX CO. 76 Cortlandt St., New York, N. Y.



Please say you saw it in RADIO NEWS

audio transformers and the two phone-tip jacks for the loud-speaker terminals at the extreme left of this line, complete the component listing.

In all stages but the last, 201A tubes have been used.

Tube Characteristics

(Continued from page 732)

results in excellent performance. An operating characteristic of this tube is that an interval of about 30 seconds, after it is turned on, is required for the cathode to heat to its functioning point. Other type numbers are 327 and N-27.

227-Type (A.C. "Heated-Cathode")

Use, detector-amplifier (not power amplifier);
 Socket, five-prong UY-type;
 Filament voltage 2.5 raw A.C.; current 1.75 amperes;
 Plate voltage 45 to 90 as detector, 90 to 180 as amplifier; current 2 ma. at 45 volts, 7 at 90 volts as detector, 3 ma. at 90 volts, 5 at 135, 6 at 180 as amplifier;
 Grid bias 6 volts at 90 plate, 9 at 135, 13½ at 180;
 A.C. plate resistance 9,000 ohms;
 Amplification factor 9.

"HIGH-MU" AND SCREEN-GRID A.C. TUBES

The Hi-Mu 26-type tube has "static" characteristics similar to the 240-type but is operated from a raw-A.C. 1.5-volt filament source, taking 1.05 amperes, like the 226-type. It is particularly adapted for use with resistance and impedance audio amplification, for which it was designed; this tube should not be used without a grid bias.

Hi-Mu 26-Type (A.C. Direct-to-Filament)

Use, amplifier (not power amplifier);
 Socket, UX-type;
 Filament voltage 1.5 raw A.C.; current 1.05 amperes;
 Plate voltage 135 and up, depending on plate resistor; current 2.6 ma.
 Grid bias 4 volts;
 Amplification factor 20.

The A.C. 22-type tube is similar in characteristics to the 222-type, except that it is designed for operation on alternating current; as the cathode is of the indirect-heater type, and similar to that found in the 227-type. The control-grid lead comes out through the top of the tube and the base has five prongs. The outer or screen-grid is connected to the base prong used in the 227-type for the control-grid. When a metallic shield with a closed top is used over this tube, it is advisable to drill a few holes in the top and bottom of the shield to allow dissipation of heat. The tube may be used as a screen-grid amplifier or as a space-charge-grid tube.

A.C. 22-Type (Screen-Grid Heater-Cathode)

Use, amplifier (not power amplifier);
 Socket, five-prong UY (connection to control-grid through top of tube);
 Filament voltage 2.5 raw A.C.; current 1.75 amperes;
 Plate voltage 135; control-grid bias 1½ volts; screen-grid voltage 45 positive. When used as space-charge amplifier, the screen-grid and control-grid interchange functions, as with the D.C. 22-type.
 Amplification factor 300 (theoretical, limited by circuit conditions) as R.F. amplifier, or 75 as space-charge amplifier.

(To be continued)

WRONG KIND OF CURRANTS

BRIDE (proudly); "I got this recipe for the pudding over the radio this morning.

HUBBY (tasting it): "Doggone that static!"

—Mollie Zacharias.



"A whispering campaign will ruin the popularity of any set owner — if the set has adenoids"

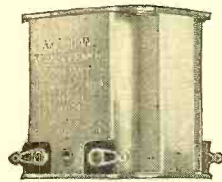

AmerTran DeLuxe—
 1st stage turn ratio, 3.
 2nd stage turn ratio, 4.
 Price each \$10.00.

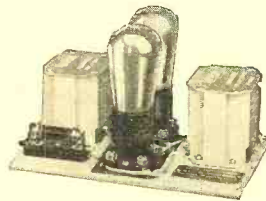

AmerTran Push-Pull Power Stage (illustrated above)—completely wired with input transformer and a choice of 4 output transformers depending on speaker and power tubes. Adaptable to 171 or 210 tubes, cones or dynamic type speakers. Price, east of Rockies—less tubes—\$36.00.

Remember it isn't what they say to your face about your set—it's what they say behind your back. And how those hammers do get busy when they get a set with "adenoids" to talk about.

Preserve the good opinion of your friends—and get the enjoyment you deserve—perform that adenoid operation today—take out the inferior transformers and in their place put AmerTran tone-trueradio products.

You can use AmerTran DeLuxe audio transformers—or push-pull for 171 tubes—or better yet the completely built Power Amplifier for two 210 type tubes and the AmerTran Hi-Power Box.

No matter what the change—if you switch to AmerTran you will improve the quality of your set.

Perform that adenoid operation today—turn the sneers to cheers! AmerTran Radio Products will do the job for you.

AMERTRAN

AMERICAN TRANSFORMER COMPANY

Builders of Transformers for more than 29 years.

31 Emmet St.

Newark, N. J.



BURIED TREASURE

can still be found in

CHEMISTRY



Good Chemists Command High Salaries

You can make yourself independent for life by unearthing one of chemistry's yet undiscovered secrets.



T. O'CONNOR SLOANE,
A.B., A.M., LL.D., Ph.D.
Noted Instructor, Lecturer and Author. Formerly Treasurer American Chemical Society and a practical chemist with many well-known achievements to his credit. Not only has Dr. Sloane taught chemistry for years, but he was for many years engaged in commercial chemistry work.

Do you remember how the tales of pirate gold used to fire your imagination and make you want to sail the uncharted seas in search of treasure and adventure? And then you would regret that such things were no longer done. But that is a mistake. They are done—today and everyday—not on desert islands, but in the chemical laboratories throughout your own country. Quietly, systematically, the chemist works. His work is difficult, but more adventurous than the blood-curdling deeds of the Spanish Main. Instead of meeting an early and violent death on some forgotten shore, he gathers wealth and honor through his invaluable contributions to humanity. Alfred Nobel, the Swedish chemist who invented dynamite, made so many millions that the income alone from his bequests provides five \$40,000 prizes every year for the advancement of science and peace. C. M. Hall, the chemist who discovered how to manufacture aluminum, made millions through this discovery. F. G. Cottrell, who devised a valuable process for recovering the waste from flue gases, James Gayley, who showed how to save enormous losses in steel manufacture, L. H. Baekeland, who invented Bakelite—these are only a few of the men to whom fortunes have come through their chemical achievements.

What Some of Our Students Say of This Course!

I have not written since I received the big set. I can still say that it far exceeded my anticipations. Since I have been studying with your school I have been appointed chemist for the Scranton Coal Co., testing all the coal and ash by proximate analysis. The lessons are helping me wonderfully, and the interesting way in which they are written makes me wait patiently for each lesson.—**MORLAIS COUZENS.**

I wish to express my appreciation of your prompt reply to my letter and to the recommendation to the General Electric Co. I intend to start the student engineering course at the works. This is somewhat along electrical lines, but the fact that I had a recommendation from a reliable school no doubt had considerable influence in helping me to secure the job.—**H. VAN BENTHUYSEN.**

So far I've been more than pleased with your course and am still doing nicely. I hope to be your honor graduate this year.—**J. M. NORKUS, JR.**

I find your course excellent and your instruction, truthfully, the clearest and best assembled I have ever taken, and yours is the fifth one I've studied.—**JAMES J. KELLY.**

Let me state that I have obtained a new and better position; this is with the Heller & Merz Aniline Dye Co. in their main laboratory. Thanks to your course I am well prepared and able to hold same.—**F. J. PHEIFFER.**

It is really the knowledge I have gained from it (the Course) that has made it possible for me to hold the job I have at present.—**W. H. YODER.**

I am more than pleased. You dig right in from the start. I am going to get somewhere with this course. I am so glad that I found you.—**A. A. CAMERON.**

I use your lessons constantly as I find it more thorough than most text books I can secure.—**WM. H. TIBBS.**

Thanking you for your lessons, which I find not only clear and concise, but wonderfully interesting. I am—**ROBT. H. TRAYLOR.**

I received employment in the Consolidated Gas Co. I appreciate very much the good service of the school when a recommendation was asked for.—**JOS. DECKER.**

Now Is the Time to Study Chemistry

Not only are there boundless opportunities for amassing wealth in Chemistry, but the profession affords congenial employment at good salaries to hundreds of thousands who merely follow out its present applications. These applications are innumerable, touching intimately every business and every product in the world. The work of the chemist can hardly be called work at all. It is the keenest and most enjoyable kind of pleasure. The days in a chemical laboratory are filled with thrilling and delightful experimentation, with the alluring prospect of a discovery that may spell Fortune always at hand to spur your enthusiasm.

You Can Learn at Home

To qualify for this remarkable calling requires elaborate specialized training. Formerly it was necessary to attend a university for several years to acquire that training, but thanks to our highly perfected and thorough system of instruction, you can now stay at home, keep your position, and let us educate you in Chemistry during your spare time. Even with only common schooling you can take our course and equip yourself for immediate practical work in a chemical laboratory. Dr. Sloane gives every one of his students the same careful, personal supervision that made him celebrated throughout his long career as a college professor. Your instruction from the very beginning is made interesting and practical, and we supply you with apparatus and chemicals for performing the fascinating analyses and experimental work that plays such a large part in our method of teaching, and you are awarded the Institute's official diploma after you have satisfactorily completed the course.

Easy Monthly Payments

You don't have to have even the small price of the course to start. You can pay for it in small monthly amounts—so small that you won't feel them. The cost of our course is very low, and includes everything, even the chemistry outfit—there are no extras to buy with our course. Our plan of monthly payments places a chemical education within the reach of everyone. Write us and let us explain our plan in full—give us the opportunity of showing you how you can qualify for a highly trained technical position without even giving up your present employment.

MAIL COUPON FOR FREE BOOK

Your name and address on the coupon will bring you by return mail our interesting free book, "OPPORTUNITIES FOR CHEMISTS," and full particulars about the course and what it will do for you. You owe it to yourself to get this book. Send the coupon right now while it is fresh in your mind. Or just write your name and address on a postal and mail it to us. But whatever you do, act today.

DON'T WAIT—MAIL COUPON NOW!

NAME

ADDRESS

CITY

R.N. FEB. '29

STATE

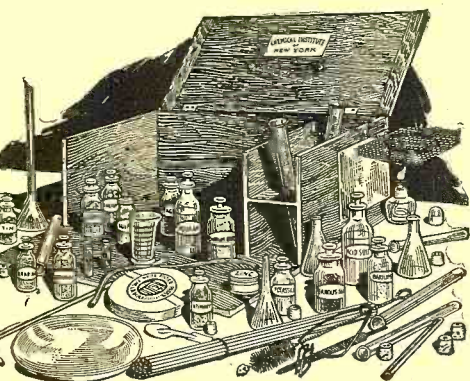

Experimental Equipment Furnished to Every Student

We give to every student, without additional charge, this chemical equipment, including fifty-two pieces of laboratory apparatus and supplies, and fifty-two different chemicals and reagents. These comprise the apparatus and chemicals used for the experimental work of the course. The fitted heavy wooden box serves not only as a case for the outfit but also as a useful laboratory accessory for performing countless experiments.

CHEMICAL INSTITUTE OF NEW YORK, Inc.

Home Extension Division 2
16-18-R-East 30th Street NEW YORK, N. Y.

CHEMICAL INSTITUTE OF NEW YORK
Home Extension Division 2
16-18-R East 30th St. NEW YORK, N. Y.

Please send me at once, without any obligation on my part, your free Book "Opportunities for Chemists," and full particulars about the Experimental Equipment given to every student. Also please tell me about your plan of payment.

Please say you saw it in RADIO NEWS

Broadcastatics

FEED 'EM AND BRING 'EM IN!

FELIPE: "Pancho, what do you think about the American broadcasting?"

PANCHO: "Oh, the music is excellent; but the announcers all seem to go to the studios before they have had supper."

FELIPE: "Why do you think so?"

PANCHO: "They all talk so faintly you can't make out the call letters!"

—Santiago R. Rodriguez (Porto Rico).

RESOURCEFUL!

SALESMAN: "This wonderful set is the latest model and has a distance range of ten thousand miles!"

CUSTOMER: "Will it get France, Germany and Japan?"

SALESMAN: "No, madam: you see it is a 100% American set and does not pick up foreign languages."

—Anthony Giordano.

WHILE YOU WAIT

Mrs. FAN: (apologetically): "My husband doesn't know much about radio yet, you know, and so last night while working with the set he blew out two tubes."

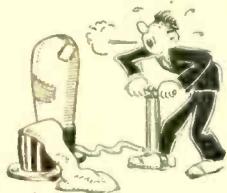

RADIO DEALER: "No—Yes?—"

Mrs. FAN: "So I brought the tubes down with me to have them blown up again."—
H. W. Thiele.

PAPA SHOULD HAVE A PORTABLE

LITTLE GIRL: "Mama, are we going to Heaven some day?"

RADIO WIDOW: "Yes, my dear, at least I hope so."

L. G.: "Wouldn't it be nice if papa could go along, too?"

R. W.: "Why, my dear, why shouldn't he?"

L. G.: "Oh no, mama, he couldn't leave the radio!"

—Mrs. Lillie H. Bartel.

A SIMPLE ERROR

(The leader of the little German band raised his baton and counted:—"Ein, Zwei, Drei.")

BRITISH FAN, excitedly:—"Crikey! I've got America!"

'ARRIET:—"Got America on that one-val-ver? Garn!"

BRITISH FAN: "Not 'arf I 'aven't! The bloomin' announcer just said 'DRY'; and that's America!"

—Oscar M. Hawkins.

NOT TOO HIGH!

TAILOR: "Yes, we have all the most fashionable suitings in stock. Which would you prefer to see first?"

DAPPER DAN (radio fan): "I think I would like to see the new voltage serges."

—Vern C. Shuttleworth.

NOT A "SOFT" ONE, EITHER

FIRST RADIO FAN: "What sort of a chap is he?"

SECOND R. F.: "Well, if he had a filament, grid and plate in his head it would make a good vacuum tube."

—E. E. Youngkin.



thrills
Big Money... and a chance to see the World

Get into
RADIO

This
Free book
tells how

Tomorrow...how would you like to set sail for Constantinople....to roam through the ancient Moslem capitalto break through the mist of age-old customs and really live the adventures you used to dream about?

Or cross the Equator to tropical Brazil....and spend merry days among dashing caballeros and starry-eyed senioritas? And sail the seven seas?

Or round the horn to Tokio, Hongkong, Shanghai....where Americans live like princes in homes that look like flower gardens.... where action, thrills, adventure greet you every day!

Man alive! You don't know what you're missing by not learning Radio!

Not only abroad, but here at home! For the radio industry is young, enterprising, full of dash and daring! And it needs men....young men with courage....young men with the love of adventure in their blood.

Don't pass it by! Get into this thrilling profession at once while the field is young and uncrowded. Send for our Free Radio Book.

**Become a Radio Expert
this fascinating way**

No matter how little you may know about Radio, you can become a full-fledged Radio specialist in a short time. By means of an amazing, unique home laboratory course conducted by the Radio Institute of America, you can now learn every phase of Radio in your spare time!

You get the "how" as well as the "why" of Radio with this fine training. Only a couple of

hours a day is all you need to devote! As part of your course, you receive absolutely free of extra charge—a magnificent outlay of apparatus. With this outfit you learn to build fine sets and solve every problem in repair work. That is why our graduates have the confidence and ability to command big pay.

**Training Sponsored by RCA...
General Electric...Westinghouse**

Our graduates enjoy greater success because they're posted right up-to-the-minute in everything in Radio. Radio's greatest achievements originate in the gigantic laboratories of RCA, General Electric and Westinghouse. These three Radio organizations sponsor every lesson in the course.

Money Back if Not Satisfied

The RIA course prepares you for success in all phases of Radio—manufacturing, servicing, selling, ship and shore broadcasting, and many others. Includes Television, Photoradiograms, and Radio equipment. A signed agreement assures you of complete satisfaction upon completion of the course—or it won't cost you a single penny!

Send for this Free Book Now. Think what Radio offers you. Money—thrills—success—adventure! Don't wait—get into this amazing field at once. Read this Free Book. It tells you things about this amazing profession you never dreamed of. And it tells you all about the famous course that has enabled us to place thousands of our students in fine positions, usually from 3 to 10 days after graduation! Mail the coupon now. Radio Institute of America, Dept. WS-2, 326 Broadway, New York.



RADIO INSTITUTE OF AMERICA,
Dept. WS-2, 326 Broadway, New York, N.Y.
Gentlemen: Please send me your big FREE 50-page book which tells about the thrills and opportunities in Radio and about your famous laboratory-method of guaranteed Radio instruction at home.

Name.....
Address.....

Please say you saw it in RADIO NEWS

Enjoy LOUD SPEAKER OPERATION from a CRYSTAL

NO "TUBES" - NO "B" BATTERIES - NO COSTLY "ELIMINATORS"

WITH THE SKINDERVIKEN TRANSMITTER UNIT

Simple microphone unit provides a most effective and inexpensive way to satisfactory speaker operation. Easy to build and operate circuit.

Everybody can do this now with a Skinderviken Transmitter Unit. The unit is fastened to the diaphragm of the speaker unit. It will act as a "microphonic relay." Every time an incoming signal actuates the diaphragm, the electrical resistance of the microphone unit will be varied correspondingly and the current from the battery, in series with it and the loud speaker, will fluctuate accordingly.

Thus the problem of securing sufficient power to actuate the loud speaker is simply and adequately solved.

The results from this very novel and simple unit will astound you.

The expense of this hook-up is trifling compared to the elaborate tube circuits that give no greater actuation of the speaker.

Besides this there are many other valuable uses in Radio Circuits for this marvelous little unit. Every builder of Radio sets should have a few on hand.

LISTENING THROUGH WALLS
This Unit makes a highly sensitive detectaphone, the real thing—you listen through walls with ease. Plenty of fun and real detective work too.

CONDUCTING SOUND THROUGH WATER

Make yourself a miniature submarine signaling apparatus like those used during the war. Simple circuit with this microphone unit gives splendid results.

12-PAGE INSTRUCTION BOOKLET containing suggestions and diagrams for innumerable uses, furnished with each unit.

P. G. MICROPHONE TRANSFORMER

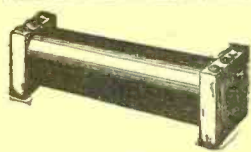

A Modulation Transformer specially designed for use with the Skinderviken Transmitter Unit. Has many other uses. Primary resistance, 1/2 ohm; secondary, 55 ohms. **\$2**

FOR SALE AT LEADING DEALERS
Or Order Direct, Using Coupon Below
SEND NO MONEY

When the postman delivers your order you pay him for whatever you have ordered, plus a few cents postage.

PRESS GUILD, INC. R.N.-2-29
16-18-R—East 30th St., New York, N. Y.

Please mail me at once as many of the following items as I have indicated.

- ...Skinderviken Transmitter Units at 95c. for 1; \$1.75 for 2; \$2.50 for 3; \$3.20 for 4.
 - ...P. G. Microphone Transformers at \$2.
- When delivered I will pay the postman the cost of the items specified plus postage.

Name.....

Address.....

City.....State.....

WHY THEY MAKE HAIR DYE
LEGMAN: "What's wrong with the Radio Editor now?"

CUB: "Some bird wrote in and wanted to know if he could pick up movies of the football games if he bought a screen-grid tube for his radio?"—*Wm. G. Mortimer.*

BEFORE AND AFTER TELEVISION
RADIO WOOPER: "You used to be the apple of my eye, sweetheart; and now you are the flicker of my neon tube."
—*E. E. Youngkin.*

THOSE TELEVISION NIGHTS!
JIGGS: "I'm stayin' in tonight, Maggie."
MAGGIE: "No, you're going out. Don't I know those bathing beauties from Atlantic City are going to be on the radio?"
—*Lester Spencer.*

AN APPELLING PROSPECT
ANNOUNCER (during morning exercise on the radio): "And our marathon pianist, Bill Mahoney, will now play 'Forever'"
—*J. A. Schultz.*

Aloft in a Gale

WHILE the broadcast engineer on the cover of last month's RADIO NEWS looked rather roseate and happy, nevertheless (with Christmas a couple of weeks ahead as this is written) we fear some engineer may find his day similarly, but less attractively, occupied. Between the preparation of the cover and the distribution of the magazine, press dispatches described the strenuous efforts of the staff of station WJZ to repair its aerial, torn down by a violent wind on election day; the feat of putting up a 2,500-pound aerial between the 700-foot towers was accomplished in less than three hours by a small crew, and the station came into the chain, broadcasting returns, only a few minutes late. A few days later WEAJ suffered temporary disability by the freezing of its cooling system in an unexpected cold snap. But seldom indeed does the broadcast engineer allow little freaks of nature like this to make a program late.

Dynamite and Radio

IN addition to the method of prospecting by radio described in the leading article of this month's issue, there is in use another which is akin to methods of sounding developed for charting the ocean bottom. These measure the time taken for a sound to travel from the surface of the water to the earth beneath, which reflects it; by this method depths may be determined with fair accuracy. In the prospecting method, a sound wave is created, say by the explosion of a small charge of dynamite, at the same instant a radio signal is sent out to observers stationed at surrounding points. The time between the arrival of the radio impulse and that of the sound impulse (through the ground, which transmits a shock more quickly than the air) indicates the density of the strata between the observers. From this a geologist may draw valuable conclusions.

It will be observed that the production of gold and silver, great as it may seem, is small compared with that of oil; and oil, as a non-conductor of electricity, does not indicate its presence as do metals and ores to the apparatus we have elsewhere described.

At Last—An Efficient SHORT-WAVE ADAPTER

Two Models: A.C. and Battery Operated
A.C. Hum Entirely Eliminated

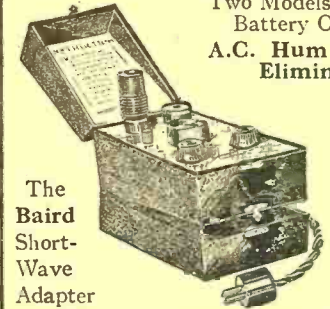

The Baird Short-Wave Adapter

List Price **\$20.00** Complete

With 4 CHIMNEY Coils

Wavelength Range: 16 to 225 Meters
Note Compartment to Hold Spare Coils
.00015 S-L-F Variable Tuning Condenser
Antenna Tuning Condenser allows for use on an outside aerial.



CHIMNEY COILS

The most efficient S.W. Coils made. Wound with bare copper wire on distinctively colored Bakelite. Electrically correct. 3 3/8 inches high, 2 inches diameter.

List Price **\$4.00** Per Set of 4 Coils

Short-wave & Television Laboratory
Dept. B
15-17 Devonshire St., Boston, Mass.

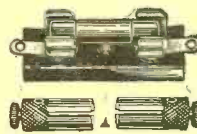

IT!!!!

LITTELFUSES HAVE IT THAT EXTREME QUICKNESS

of action necessary to protect radio and rectifier tubes, filter circuits, galvanometers, milliammeters, etc. (1/4" x 1/4" dia.). Approved by leading radio laboratories. Mount as shown or hang directly in the line by pushing on a pair of GRYP-CONNECTORS. Liberal discount to dealers.
Prices, postpaid (C.O.D. or cash unless rated):
Littelfuses, 1/32, 1/16, 1/8, 1/4, 1/2, 1, 3 Ea. Doz. Per 100
2, 3 amp. \$.15 \$1.50 \$10.00
Mounting Blocks20 2.00 15.00
GRYP-Connectors—in pairs15 1.50 10.00
Littelfuse Laboratories, Dept. 4, 1772 Wilson Av., Chicago

**Send For This Book—
It Offers More Profits to Set Builders!**

BARAWIK, THE OLD RELIABLE RADIO SERVICE

Radio Fans, from "way back when," will remember the exceptional service that Barawik rendered when setting radio parts was like pulling hens teeth. First upon the scene, Barawik was always ready to deliver the newest developments in radio to its customers in the days when changes were fast and furious.
Today Barawik has grown to be a mighty institution in the radio world. Here you can secure the proved, reliable merchandise of the world's leading radio manufacturers—everything from complete sets to the smallest individual parts so upon the reliability of Barawik's honesty, you can depend upon Barawik's ability to deliver the kind of service that means time saved in waiting. You can depend upon Barawik's honesty, ability and willingness to serve you—And, last, but far from least, you know that Barawik's big discounts assure you of the lowest prices always—prices that mean huge savings to you in everything you buy.
The newest in radio sets, parts, kits, supplies—all under one roof—ready for you now. Send coupon now for big new Catalog—Free.

BARAWIK CO.
12C Canal Sta.,
CHICAGO,
U. S. A.
Mail this Coupon Now for Barawik's Big Free Bargain Book.
Name..... Address..... City.....

Please say you saw it in RADIO NEWS

RADIO DIRECTORY

RADIO-LITE-TENNA



Write for details

AERIAL INS. CO.
GREEN BAY, WIS.

Send for This

We have a new illustrated catalog showing our up-to-the-minute stock of kits, parts and sets — everything you want in radio — all at dealers' wholesale prices. Write today for Catalog "B-3."

ALLIED RADIO CORPORATION
711 W. Lake St.
Dept. "B-4," Chicago, Ill.



ACCUSTI-CONE
(Double Diaphragm)
Aeroplane Cloth Speaker

Truly a revolutionary step in radio reproduction! Send for catalog. Accusti-Cone Laboratories
One No. Seventh St., Phila., Pa.



BIRNBACH

Moisture-Proof Extension Cords

Birnbach Extension Cords permit the Loud Speaker to be moved to any room in the house. Attaches instantly. Install a Birnbach Cord often due to badly insulated cords. Your neighborhood dealer has these sizes in stock: 10-20-30-40-50-100 foot lengths. Send for Catalog.

BIRNBACH RADIO CO.
254 W. 31st St., New York



PER-CON COLLAPSIBLE RADIO GROUND

A perfect efficient and noiseless ground. Consists of three sections. Drive one at a time. Easy to drive any length required. Contact point copper, to which is soldered lead-in wire. Drive in basement or in close places.

PER-CON MFG. CO.
Richmond Indiana

FREE Wholesale CATALOG

Send for the most complete book of nationally known Parts, Kits, Cabinets, Consoles, Speakers, Power Units, Sets, etc. All at lowest wholesale prices. Quick service on all your needs. Write now, it is FREE—

Setbuilders Supply Co.
1311 Romberg Bldg., Chicago

HELLO JAPAN!



Hello China; Hello Australia; Hello New Zealand; Hello Ireland; Hello Danzig, 9,000 miles away; Hello Iceland, 10,000 miles away. All continents Reception. Most amazing performance of any Itadio Receiver ever designed. U. S. Stations all locals on the Magnafomer 9-8. Write today for FREE X-RAY Wiring Diagram and Instruction Sheet.

Radiart Laboratories Co.
1012B Assn. Bldg., Chicago, Ill.



BODINE ELECTRIC TURNTABLE

For radio-phonograph combinations — no brushes, no commutators, no sparking. Positively no interference in the loudspeaker. Write today for full information on this big new development.

BODINE ELECTRIC CO.
2264 West Ohio St., Chicago, Ill.

Shield Grid PLUG-IN KIT

No. 222



An efficient shield grid plug-in kit consisting of two units Nos. 222A and 222C for use in the foremost shield grid circuits. Write for literature.

Twin Coupler Company
Poughkeepsie New York

LUND RADIO CABINETS

Our line includes twenty different models. There is a suitable cabinet or table for every set and every requirement. Write for complete illustrated catalog.

I. A. LUND CORP.
1018 S. Wabash Av.
CHICAGO

Model 5, Walnut
Price \$25.00

SEND NOW for New 1929 WESTERN RADIO'S CATALOG

LATEST and FINEST, nationally known A.C. sets, consoles, cabinets, speakers and accessories at LOVEST PRICES. Catalog sent FREE on request.

WESTERN RADIO MFG. CO.
128 W. Lake St.
Dept. RNC2 Chicago

CORNISH Braidite

HOOK UP WIRE THE BRAID SLIDES BACK

AT ALL DEALERS

25 ft. Stranded	35c
25 ft. Solid	30c

Red Green Yellow
Blue Black
Send 10c for sample

CORNISH WIRE CO.
24 Church St., New York

200,000 RADIO NEWS readers carefully scan the RADIO DIRECTORY every month.

YOUR product here, at the lowest cost in the world's largest and most widely read radio magazine.

RATE PER ISSUE \$25.00

No order for less than three insertions accepted. Write for information.

Radio News, 230 5th Ave.



HEAVY DUTY "B" POWER — \$18.50

Complete with Tube. Delivers up to 180 volts on any set. Dry — no liquids. Write for literature.

FERBEND ELECTRIC CO.
425 W. Superior St., Chicago, Ill.

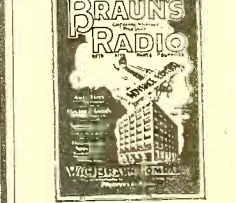

BRAUN'S RADIO

Dealers, write for catalog.

W. C. BRAUN CO.
552A Monroe St., Chicago

NOPHONIC TUBE CAPS

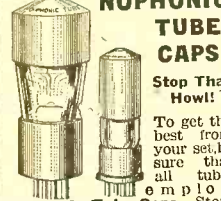

Stop That Howl!

To get the best from your set, be sure that all tubes employ Nophon Tube Caps. Stops all vibration of the filament.

MERTZ SPECIALTY CO.
1306 Stockton Street
Wilmington, Del.

RADIO'S HALLMARK OF QUALITY

DeJur AmSCO

WORLD'S LARGEST MANUFACTURER OF HIGH GRADE RADIO PARTS

USED BY LEADING SET MANUFACTURERS AND SPECIFIED IN ALL THE BEST CIRCUITS

WRITE FOR CATALOG
DE-JUR AMSCO CORP
BROOME AND LAFAYETTE STS
NEW YORK CITY

SEND FOR NEW RADIO BOOK

All the new hook-ups. Parts, supplies, A.C. sets, television, short wave, etc.

Write for free copy now.

The Barawick Co.
21W Canal Sta., Chicago

Balkite Radio

In cabinets by Berkey & Gay



Fansteel Products Co., Inc.
NORTH CHICAGO, ILL.

TELEVISION Kits and Parts

Complete receivers assembled in 15 minutes. 5 models from \$37.50 up.

DISCS MOTORS NEON TUBES AMPLIFIERS and other parts

Write for Catalog
Insuline Corp. of America
78-80 Cortlandt St., N. Y. C.

DOUBLE DISTANCE and VOLUME NEW TUBE



The **PREXTO** tube increases Volume and Distance. Brings many distant stations in like locals. Its use often results as though an additional tube had been added to the receiver. Insert tube in detector socket. Used in any set using 201-A tubes. Guaranteed for 1 year. Tested by **RADIO NEWS, RADIO WORLD** and the **RADIO DIGEST**, and other leading publications. 25,000 users today. Money back guarantee with every tube. **ORDER TODAY** and enjoy those DISTANT stations. Price \$3.00.

WHAT USERS SAY

"Your tube cannot be beat." Fred Geiger, St. Joseph, Mo.
"Pick up stations I could not get before now using your tube. Distance and volume increased 50% and more." Jas. T. Garrison, Duennweg, Mo.
"I am delighted with your tube. It sure has the power and kick." George B. May, San Jose, Calif.
"Your tube a wonder for distance, volume and selectivity." R. O. Dorman, Seymour, Conn.
And hundreds of other letters from users. **ORDER NOW.**

PREXTO MFG. CO. Dept. 3, Beaumont, Texas

GOOD FOR DISTANCE

Editor, RADIO NEWS:

I have been a reader for some time, and have built several of the sets described in your issues. Considering distance as the most important factor in reception (as it has always been with me) I find that the "Milk-Shaker Special" described in your October, 1928, issue is the best.

Before I built this I had a two-tube regenerative set. I could receive most anything from Denver east, but never had the luck of picking up anything west of there. After building the M. S. S., I sat up one night and got KFI, KNX, KFNB, KFON, KGER, KHJ, KNRC and one other station—all in and around Los Angeles—also KFBB, Havre, Montana. Now I call that fine for the first night that I did any DX work at all.

RADIO NEWS has a very fine policy; it gives more data as to building the sets than just buying the parts and mounting them, as most magazines do. I like your Short-Wave section, "I Want to Know," Radio Wrinkles and The Listener Speaks.

RALPH S. BARNES.
917 So. St. Francis Ave.,
Wichita, Kansas.

Complete Parts for New TYRMAN IMPERIAL "80"

Complete A.C. Socket Power Operation. Uses A.C. Shielded Grid and A.C. Heater Type tubes. Fully described in our free catalog.

1929 Catalog—FREE

Includes description and complete parts for H. F. L. Isotone, Madison-Moore "A. C." New Thordarson Power Amplifier, World's finest Dynamic Speaker.

Discounts for Set Builders

CHI-RAD
CHICAGO RADIO APPARATUS CO.
415 S. Dearborn St., Dept. RN
CHICAGO

The RADIO DIRECTORY is your buying guide. Space permits display of only one product at a time. Write advertisers for complete catalogue.

A MARVELOUS MONEY-MAKING OPPORTUNITY

LAFAYETTE Electric RADIOS for Agents & Dealers

30 DAY FREE TRIAL



Complete with Cabinet
Built In Our Own Factory

Get your copy of our new 1929 Radio Catalog—just off the press—64 beautifully illustrated pages, containing a wealth of money makers for you in Super-value Radio Sets and nationally advertised equipment, featuring 14 NEW Lafayette ALL-Electric Radio Models.

Lafayette All-Electric Radio Receivers present a record achievement in super quality, tone and volume receptivity.

POWERFUL-SENSITIVE-SELECTIVE
Introducing exclusive improvements:

8 tubes, two 171A Power tubes in dynamic "A" metal push and pull audio amplification, single dial illuminated drum control, and all parts perfectly balanced and matched, attachable to your home electric light current.

BONA FIDE GUARANTEE
Every Lafayette Receiver is unconditionally guaranteed to be free from defects in workmanship and material.

Wholesale Radio Service Co.
8 Church Street New York City



FREE!
This 1929 Catalogue sent on request

Radiotics

"HUSH," SHE REVERBERATED

Announcement by David Sarnoff, according to the veracious pages of *Motion Pictures Today* of August 11, that "to obtain interchangeability of sound films, RCA Photophone has now adopted a sound track 80 MILES in width," leads us only to the conclusion that the magnitude of the talking-movie industry has never been fully appreciated by any outsider. No wonder some of these stage whisperers sound like Niagara falling over the Rocky Mountains.—Stafford M. Price.

WE FEARED AS MUCH!

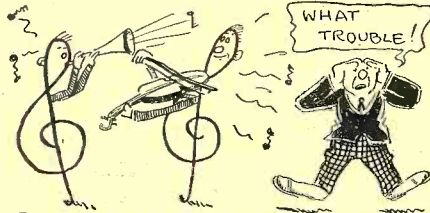

Radio fans who have just overhauled the set and put in new A. F. transformers will learn that the whole trouble lay at the broadcast station. The *Valparaiso* (Ind.) *Vidette-Messenger* gives the whole thing away with this front-page story in its issue of August 31: "An entertainment by the TROUBLE Clef Players occupying the whole afternoon—" Oh, rawsberries!—Charles Wooms.

TING-A-LING-A-LING!

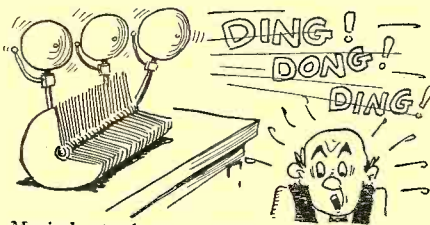

Musical attachment advertised in the *Toronto Star* of September 7: "3-GONG Condenser, 2 controls only, special \$7.50." A bets B that this is to get the Swiss bell ringers; B bets A that it is to bring in the time signals. Both lose; the gongs ring when you get the condensers properly trimmed.—Wm. G. Mortimer

HONESTY IS THE BEST POLICY

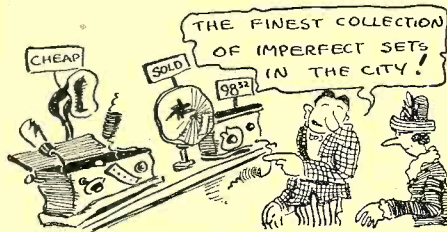

Amazing commercial candor blazes from the advertising pages of the *Rochester Democrat & Chronicle* of September 13: "Radio Bargains! A wonderful display of demonstrating radios at big reductions. Absolutely IMPERFECT condition." Mike went over to see if he could salvage anything and reported that there were two good binding posts in the lot; otherwise as advertised.—Harry E. Herring.

THE COMPLETE NURSERY

How the up-to-date home is replenished may be determined from this advertisement of radio equipment which we take from the *Cumminsville* (Cincinnati) *Home News* of some time ago:
FIVE AMP. HOMECHARGER—Baby's ivory bassinet and mattress; ivory health bowl; pair baby shoes, size 3½, practically new; pair ladies white kid slippers, size 5½C. At 4247 Fergus St., upstairs.
With such a supply of accessories, the Bedtime Story hour should be filled with cheer.—Mrs. C. F. Schreiber.

NEW! 90 Volt Power Unit

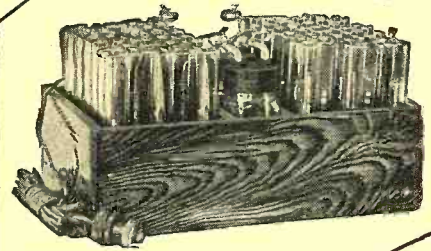

Positively Eliminates Hums, Line Noises, etc. Greater Volume and Clarity Guaranteed \$ **2.75**

Non-acid and noiseless. All detector and intermediate voltages plainly marked. Simpler to hook up than dry cells. Operates 1 to 12 tubes. If not thoroughly satisfied return after using 30 days for complete refund. Guaranteed further 2 years. For 110-120 volts A. C. 25 to 60 cycle current, 90 volts, \$13.75; 112½, \$15.25; 135, \$17.50; 157½, \$19.50; 180, \$24.00; 202½, \$26.00. Also built for D.C. current 110 and 32 volts at only \$3.00 additional, any size above. Ample stocks—same day shipments. Simply say—ship C.O.D. or write for my interesting literature, testimonials, etc.

B. HAWLEY SMITH
334 Washington Ave., Danbury, Conn., U.S.A.

Is Your Set ENTIRELY A. C.?



Manufactured and unqualifiedly guaranteed by the makers of the X. L. Variodenset. If your dealer cannot supply you, it will be sent postpaid on receipt of price.

XL Radio Laboratories

Dept. A, 1224 Belmont Ave., Chicago, Ill.

Before Buying any "A" Eliminator

Get my authorized Discount Card and complete description of the finest "A" Power Kit ever offered.

DAVID W. KNAPP, Pres.
Knapp Electric, Inc.
Division of P. R. Mallory & Co., Inc.
Room 417a, 350 Madison Ave., N. Y. C.

SM DEALERS and SETBUILDERS

Complete stock of nationally known parts and accessories. Send for illustrated catalog and discount sheet.
Radio Exclusively Since 1921!

CLARK & TILSON, INC.

22 CHAMBERS STREET NEW YORK
The Nationally Known House

AUDIO TRANSFORMERS 97C

Think of it! A \$4.00 audio transformer—unit of the finest Illinois' all frequency unit of the finest musical capability, offered direct from the factory for only 97c each! A real bargain opportunity. Thousands have bought them. Sold with positive guarantee of satisfaction or money back. Supplied in ratios of 1½ to 1, 3 to 1, and 5 to 1. Order now. **ILLINOIS TRANSFORMER CO.**
Dept. 112 223 W. Elm St. Chicago, Ill.

More Profits To Set Builders

One good radio idea may be worth millions. Barawik has thousands of ideas for radio set builders to make more money. **Barawik's Big Radio Book** will help you while elections are on and big national events stir the world.



Send for your copy today — NOW!
BARAWIK CO. 22F Canal Station, CHICAGO, U. S. A.

Mail This Coupon Now! For Free Copy

Name

Address

Omnigraph CODE TRAINING

LEARN Make Progress Easy

AT HOME Has Helped Many BIG RADIO and TELEGRAPH Men Win Success

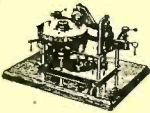

The **OMNIGRAPH** Automatic Transmitter will teach you the Wireless or Morse Codes, easily, quickly and cheaply. Start now. Ideal opportunities for you as an operator, broadcaster, experimenter or railroad official, etc. U. S. Government, radio

schools and scientific institutions throughout the world use the **OMNIGRAPH**. Ask your Radio Dealer about it. Free Catalog.
OMNIGRAPH MFG. CO.
810 E. 39th Street Dept. M Brooklyn, N. Y.

FREE Wholesale Radio Catalog

Set Builders-Dealers! Save Money!
Send for the most complete book of nationally known Parts, Kits, Cabinets, Consoles, Speakers, Power Units, Sets, etc. All at lowest wholesale prices. Quick service on all your needs. Write now, it is FREE—

SETBUILDERS SUPPLY CO.
Dept. 1310 Romberg Bldg. Madison and Market Sts. CHICAGO, ILL.

Please say you saw it in RADIO NEWS

ISN'T CHEMISTRY WONDERFUL?



Announcement of the Rudolph Wurlitzer Co. in the *Chicago Tribune* of September 9: "With the New ALKALIZATION to radio broadcasting stations, every station comes in clear without interference from any other"—Quick, Watson, the litmus paper! Some of those "sour notes" will require a good deal of neutralizing.
—Charles Weems.

A GOOD TRICK FOR DUNNINGER

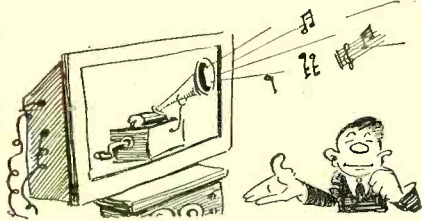

Prediction of a new way to furnish the home, voiced by the *Toronto Mail & Express* of September 17: "Among apparatus demonstrated to the public for the first time will be the radio photo device capable of picking radio impulses out of the air and converting them into a complete PHONOGRAM." We intend to tune in early on the evening when they transmit a grand piano.
—J. H. Cadman.

A SHOCKING POLITICAL DEAL

The important part radio is now taking in public life has been insufficiently suspected by those who failed to note this dispatch in the *Cleveland Press* of September 21: "Samuel Doerfler, former county prosecutor, asked Prosecutor



Edward C. Stanton to institute suit to compel the Board of ELECTRONS to burn the ballots cast at the August primary." In other words, electrocute the ballots, as it were.—C. J. Fisher.

DON'T BLOCK THE PLATE

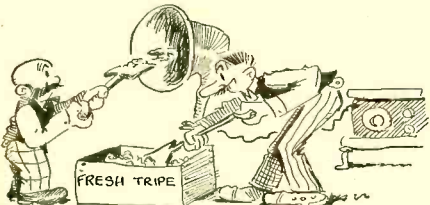

Our old friends, Mutt and Jeff, would have leaped with delight at the sale of "Balkite TRIPE chargers" announced by McPherson Radio, Ltd., in the *Montreal Gazette* of September 24. Only \$5.55 at that, and it should ensure an unflinching supply of their favorite delicacy.—Mrs. Will Shaw

STRAYED, OR STOLEN, STAFF

Demoralization of the studio personnel is indicated in the announcement by the *Columbus (Ohio) Dispatch* that "WAIU will be off the air Thursday night, but arrangements will be made so that Friday's program will go on the air. It will require at least two or more MOUTHS to replace lost equipment." Announcers, tenors, sopranos, or saxofends?—James Gibson.

Now...4 or 6 Volts
with the
Improved
Knapp
"A" POWER



Operates on 105 to 120 volts, 50 to 60 cycles.



The only "A" Power
Suitable for all Sets

— Irrespective of number of tubes — including
SuperHets, Short Wave and Television receivers

THE new Knapp "A" Power is designed for the most exacting service — super-hets, short wave and television receivers included. I knew that if it would perform satisfactorily with these receivers that there could be no question as to its efficiency on ordinary broadcast signals. The three Elkon dry condensers, the improved choke coils and the special Elkon dry rectifier make the difference between ordinary and Knapp performance.

No Change in Price

Even with these wonderful and costly improvements, there has been no advance in price—due to the tremendous volume going thru my plant. Remember that the Knapp is the fastest selling "A" Power on the market.



David W. Knapp, Pres.

KNAPP ELECTRIC, Inc.

—Division of P. R. Mallory & Co., Inc.—
350 Madison Ave., New York City

See your dealer today

Go to your dealer today. Most of the good ones carry the Knapp in stock. Do not accept a substitute—because only in the Knapp will you get full satisfaction as typified by the famous Knapp "A" Power. If your dealer cannot supply you send the coupon.

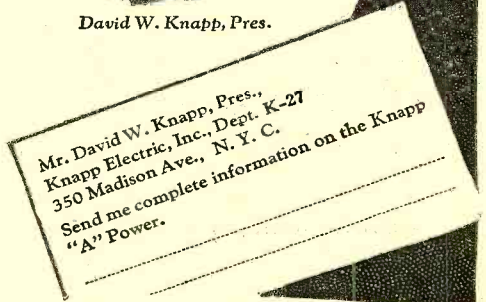

Mr. David W. Knapp, Pres.,
Knapp Electric, Inc., Dept. K-27
350 Madison Ave., N. Y. C.
Send me complete information on the Knapp
"A" Power.

Please say you saw it in RADIO NEWS

"Standard of the World"

A fitting title for

VICTOREEN

Super Receivers

Down thru the years, from the very beginning of Radio, Victoreen has kept ahead of its time. Developments from the Victoreen Laboratories are constantly ADVANCE announcements of radical improvements in radio reception.

The New Victoreen Circuit for 1929 eclipses all past achievement. It combines unparalleled sensitivity, selectivity and tone quality.

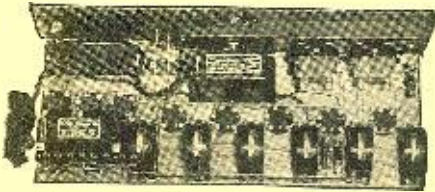

Perfected A. C. Operation

Until you have heard and used a 1929 A. C. Victoreen you cannot realize what a wonderful receiver it is. Stations that you have never heard before, together with all the old favorites, are at your instant command.

The heart of this master circuit is the Victoreen Super Transformer, vastly improved for 1929, tuned and matched to a precision of 1/3 of one per cent. In addition, the Victoreen Circuit itself contains improvements far ahead of its time.

Complete Kits Available

Either A. C. or D. C.

Write us for complete information regarding the latest Victoreen developments.

Blue Prints and Assembly instructions are FREE. State whether you wish A. C. or D. C.

Victoreen Power Amplifier and "B" Supply

for Best Results from Any Receiver

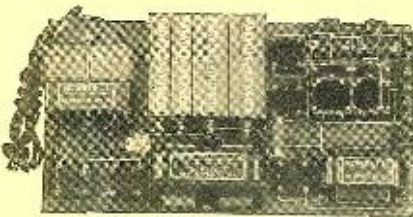

Supplies 45, 90, 180 and 450 volts, using a UX 210 or 250 in the last stages. Contains two voltage regulator tubes so that the 90 and 180 volt taps are supplied with a constant volt potential. It is the last word in "B" Supply. For the most satisfactory results you must have it.

FREE BLUE PRINTS, with list of parts and complete assembly instructions, will be sent upon request.

The George W. Walker Company
Merchandisers of Victoreen Radio Products
2825 Chester Ave., Cleveland, Ohio.

Victoreen

Quality Radio Parts

On the Short Waves

(Continued from page 751)

gives wonderful volume, with no body capacity. I use a 400-foot aerial, a three-stage audio amplifier, plus a 210 power stage leading into a dynamic speaker; 5SW, 2ME, 3LO, PCJJ and PCLL, as well as the transatlantic phone at times will operate the speaker.

KDKA on 63 meters is good day or night; on 25.4 meters only by day like W2XAD and W2XAF. Chelmsford, 5SW, is variable; it can be heard nearly every afternoon but Saturday and Sunday.

The London end of the transatlantic phone, between 7 a. m. and 6 p. m. (EST) comes in variably, best about noon. The New York end, 23, 28 and 33 meters, between 7 a. m. and 9 p. m., is good on all wavelengths.

PCJJ from 2 to 3 p. m. on Fridays is fair; PCLL at Kootwijk from 7:30 to 10 a. m. on Wednesdays and Thursdays is good. Bandoeng, Java, from 8 a. m. onwards Wednesday and Thursday is always weak. RFN, Khabarovsk, Russia, at 6 a. m. Saturdays has fair music but the announcements are poor.

Sydney, Australia, 2ME, is received around 6 a. m. four times a week, and is best around 6:30; Melbourne, 3LO, is good at 8 a. m. Saturdays and poor on Sundays, from 2 to 3 p. m. I have heard unidentified stations in foreign languages on 16 and 35 meters.

BRUCE T. O'LEARY,
Postal Dept., Marshall, Mich.

A JOLLY MARINER

Editor, RADIO NEWS:

I am using the regular RADIO NEWS Special Short-Wave Receiver described by Kendall Clough with a couple of changes of my own. The coils are old B.T. units with the three prongs shuntships and one prong aft with the tickler and secondary grounded; and instead of using an audio-transformer secondary as grid-leak I used a Bradleyleak which pepped the set up about 500 per cent. With the Bradleyleak knob as a control, volume can be brought from good phone reception absolutely minus static or dynamo noises to loud-speaker volume but with some mechanical noise which does not interfere much. All this is with antediluvian tubes; my detector is an old brass-baser with the short prongs and the others have been rejuvenated so much I think I'll have to have their glands renewed! Aerials are not critical and I am now using a 40-foot, four wire cage which seems as good as any I've tried, and a ground is optional.

WALTER EWART,

Chief Mate, S.S. Mariana,

Off Great Inagua Island, West Indies.

(Chief Ewart's log of short-wave stations received looks like the index to an atlas. However, reception conditions on land cannot be compared with those at sea where conditions are comparatively ideal.)

THE "JUNK BOX" AGAIN—AND YET

Editor, RADIO NEWS:

I have added, with excellent results, an additional stage of audio amplification to the "Junk-Box." Some of the receiver's efficiency may be due to the antenna which is 100 feet long and strung between two 12-foot poles. Also, I have seven distinct grounds, (Combined or used singly?)—Editor.) which aid in improving reception. For those who have trouble with an extra stage, try a .002-mf. condenser across the "B+" post and the plate post of the first transformer, and a .006-mf. condenser from the plate of the last tube to the "F" post. Also, my aerial is grounded at the far end.

JAMES FERGUSON,

124 Fourth Avenue, Verdun, Montreal, Canada.

A SHORT-WAVE SUPER

Editor, RADIO NEWS:

Having been a constant reader of RADIO NEWS for about five years and enjoying very much the articles in the short-wave section, I would like to suggest to short-wave fans who have access to a good superheterodyne receiving set that the possibilities of this set on short wavelengths are exceptional.

I have two eight-tube sets; one is used on a loop, the other on an outside antenna. On this set I have constructed a separate oscillator and detector unit, using the Silver Marshall Laboratory circuit, with S.M. coil-form bases and .00035 tuning condensers.

I have at the present only one set of two coils; the oscillator coil has three- and four-turn windings, and the antenna coil two equal windings of three turns each. The rotors are the ones usually

PHONO Radio Consoles

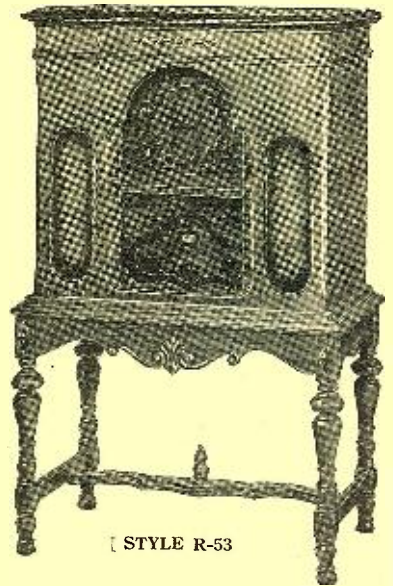

STYLE R-53

For Radio or Phono-Radio Combination. A beautiful Walnut Cabinet with sliding doors of matched Butt Walnut. Ample space for Receiver, Speaker, and Phonograph equipment.

A descriptive bulletin of new 1929 styles sent free on request.

EXCELLO PRODUCTS CORPORATION
4832 West 16th St., Cicero, Illinois

GET MY DISCOUNT CARD!

Before buying a
KNAPP "A" POWER KIT
Absolutely dry—Magically
silent—the finest "A" Power
adaptable to Short Wave,
Super-Heterodyne and Tele-
vision reception.

**WITH THE
10 NEW IMPROVEMENTS**
Write me today for details of this
money saving plan and get your dis-
count card. Address

DAVID W. KNAPP, Pres.
Knapp Electric, Inc.
Division of P. R. Mallory & Co., Inc.

Room 417a, 350 Madison Ave., N. Y. C.

SET BUILDERS Get this Book

LATEST
RADIO
GUIDE

FREE

Barawik, the first and oldest radio specialty house, offers you unusual service this year. Bigger stocks, quicker shipments, lower prices. Deal with an old established, reliable house. Get honest goods, honest service, honest prices. Barawik service makes you more money. Send now for big new Catalog showing lowest wholesale prices.

BARAWIK CO. 22H Canal Sta. CHICAGO, U. S. A.

Mail This Coupon Now for Free Radio Guide

Name _____

Address _____

Please say you saw it in RADIO NEWS

used for ordinary broadcast reception. The output of this unit is connected to the first intermediate-frequency transformer primary in the set.

With this set of coils I have already been able to obtain very fine reception of the following stations: CJRX 25.60 meters; 5SW 24.30 meters; PCTT 21 meters; KDKA 27, 42 and 75 meters; WSNAL 49.96 meters; W2NAF 31.40 and W2XAD 21.96 meters; also a large number of amateur stations. The set handles very easily; the tuning of the oscillator is of course rather sharp. With the midget condenser in the detector circuit I am able to make the set oscillate on the very short waves without any critical adjustments.

This unit may also be constructed to plug into the first-detector socket of the set. I obtain slightly better results by using separate batteries on the units.

Hoping to see more in the short-wave column, I am, yours for short waves,

J. ROBERT JOHNSON,
1026½ Vermont St., Quincy, Ill.

A CORRECTION

Editor, RADIO NEWS:

I have before me the November issue of RADIO NEWS, and, in going over diagram as given by me for the construction of a short-wave set, I notice an omission in the specifications as given which I would thank you to correct; so that no misunderstanding will be occasioned to parties desiring to build the receiver as mentioned. In the specification following the words: Up to 50 meters, grid windings, 3 turns of No. 28 wire on ¼-inch tube—same should read 3 turns of No. 28 wire on 1¼-inch tube.

After sending you the diagram, I have made a slight change in the 40-meter band which I use in my present receiver. The construction of coil is as follows:

3 turns of No. 20 enameled wire wound on a 3-inch tube for tickler, and 2 turns for the secondary wound over the other. All other coils remain the same as originally given by me.

EUGENIO D'ANGELO,
69-71 Dundas St. West
Toronto 2, Ontario, Canada.

AN OLD TRICK, BUT GOOD

Editor, RADIO NEWS:

I will say the "Junk-Box" has got everything skinned a mile for distance and enjoyment. I hooked up my set and got KDKA and five other stations, including one in Los Angeles, in about half an hour the first night, on one coil. I found that, by taking a potentiometer instead of an R.F. choke coil, you will get results just as good and will be able to set it at any desired number of turns. (An old "ham" trick—the potentiometer, of course, must be wire-wound and not of the non-inductive type. This is good only on short waves.) By using rheostats instead of ballasts, also, you will have greater control of oscillation. I have shielded the panel, and am no longer troubled with body capacity.

JOHN COLLIER,
Monroeville, Ohio.

THE PLUGLESS WONDER

Editor, RADIO NEWS:

I constructed the Plugless Short-Wave Receiver described in your December issue and have had very good results. For the tuning condenser I used an old variable condenser of .0005-mf., which I cut down to six plates. This circuit worked the first time I tried it, and the first phone station to be received was CJRX at Winnipeg, Manitoba, on 25.6 meters. However, I find that a tube of the 199-type will not oscillate below thirty meters, so it is a waste of time to try them in any such circuit. (Whoa!—EDITOR.) Although I am only 15 years of age, I am an ardent radio fan, and would like to communicate with other boys about short-wave and broadcast equipment.

J. LAWRENCE EVANS, JR.,
893 Park Avenue, Woodcliff, N. J.

(Our correspondent seems to be experiencing some difficulty with his tubes. Amateurs doing research work on waves as low as 10 meters have had no trouble in getting the 199-tube to oscillate. We suggest a different 199 tube.)

MISCELLANEOUS PRESCRIPTIONS

Editor, RADIO NEWS:

No doubt there are many who are troubled with the second stage of audio on a short-wave receiver. I have this to offer: reverse the secondary connections on the second-stage transformer, and this will stop the whistle when nothing else will.

LOUIS J. LABASH,
Zeigler, Illinois.

In Response To Popular Demand

CHARLES R. LEUTZ

announces



A NEW BROADCAST RECEIVER

LEUTZ Broadcast Receivers are known all over as the "Highest Grade Radio Receivers in the World." In proportion to their price, there is more money spent on material and labor than in any competitive make, this means you get **QUALITY**.

The LEUTZ organization has always led the field in new and original features in their designs. Many of this year's sales points in competitive makes, are features which were original with Leutz two and three years ago. In a Leutz receiver, you obtain an instrument scientifically correct, the best that engineering skill can produce.

The present two models, the Universal Transoceanic "PHANTOM" and "SILVER GHOST" are continued as before, for the clientele that insist on the best with no limitations of size, simplicity or cost.

In response to the many inquiries for a popular priced broadcast receiver, simple to operate and scientifically designed to give superior performance, LEUTZ offers a new **SINGLE CONTROL CONSOLE**. The result is not just another console, but an instrument original in many details. The wonderfully efficient Screened Grid Tubes are used in the radio frequency amplifier. A very powerful Push-Pull power audio amplifier is provided to operate an improved type of Dynamic Speaker which is built in the console. All electric operation is obtained at a very economical figure. The console itself is a fine example of woodworkers' craftsmanship.

The design and construction throughout is to the typical Leutz high standards, the performance sets new ideals.

We will be very glad to send you the new literature on this new console, you will find it very interesting, write now.

C. R. LEUTZ INC.

195 PARK PLACE

LONG ISLAND CITY, N. Y.

Cables "EXPERINFO" N. Y.

BASHFUL?

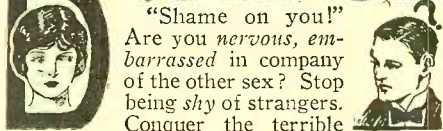

"Shame on you!"
Are you nervous, embarrassed in company of the other sex? Stop being shy of strangers. Conquer the terrible fear of your superiors.
Be cheerful and confident of your future!
Your faults easily overcome so you can enjoy life to the fullest. Send 25c. for this amazing book.

RICHARD BLACKSTONE
B-19X, Flatiron Building, New York

FREE BOOK

New Hook-ups. This book shows how to make Short-Wave Receivers, and Short-Wave Adapters.
How to use the new screened-grid tube in D.C. and A.C. circuits.
How to build Power Amplifiers, and A.C. Eliminators. Up-to-the-minute information on all new radio developments.
Set Builders, Fans, Dealers, send for it today.



Write for it!

KARAS ELECTRIC COMPANY 4038B
4038B N. Rockwell St., Chicago, Illinois
Please send me your Free Book!
Name
Address
City State

Insure your copy reaching you each month. Subscribe to Radio News—\$2.50 a year.
Experimenter Publishing Co., 230 Fifth Avenue, N. Y. C.

Please say you saw it in RADIO NEWS

COAST TO COAST

With Tremendous Volume is the Report of Every Builder of
THE LINCOLN 8-80 ONE SPOT SUPER



75 STATIONS LOGGED THRU CHICAGO LOCAL

report set builders in Chicago, the worst city in the United States for DX reception.

Here's the reason—note these exclusive features:

- ONE SPOT—10 KC SELECTIVITY WITH FULL POWER;
- FOUR SCREEN GRID TUBES WITH NEW INTERMEDIATE MANUALLY TUNED, GIVING TREMENDOUS AMPLIFICATION;
- REGENERATION ABSOLUTELY ELIMINATED;
- NO SQUEAL POSSIBLE;
- MARVELOUS TONE;
- CLOUGH SYSTEM OF AUDIO.

If you want performance you never knew was possible, write us at once for full information.

Lincoln Radio Corporation

Dept. N
Corner Wood and Ogden CHICAGO, ILL.
— Established 1923 —
Send 25c for booklet giving constructional data and complete story of development of the Lincoln 8-80.

I thought some other readers would like to know how I got rid of body-capacity in the "Junk-Box." At first the tuning condenser had seven plates, which caused it to tune very sharp. I removed two of the plates and found that not only did the set tune broad, but I can now place my hand on the coils and the signals do not change.

JAMES FORGEY,
700 Penn Ave., Bristol, Tenn.

The "Junk-Box" caused me a lot of worry and there was nothing but disappointment in my system. I read of the many successes other builders enjoyed, and wondered what ailed my set. However, I had no idea of giving up and, after I had connected a .000015-mf. variable in the aerial circuit (instead of that in the official parts list) the set turned out to be the snappiest thing I have ever had the pleasure of dialing. With the variable in the circuit, it completely stopped body capacity. I have received foreign stations by using a two-wire aerial. Each leg is 50 feet long; they join at the lead-in, which adds about fifteen feet.

E. A. CORREA,
Keswick, Virginia.

(Remembering the story of the doctor who found empirically that sauerkraut is a stimulant for sick Germans, and toxic to Frenchmen, we hesitate to pass on as a panacea any prescription for the ills of a radio set. It is difficult to see how removing a couple of plates from a condenser would cure body capacity, but the connections of stator and rotor plates may have been interchanged during the operation. Reversing connections on windings, both R.F. and A.F., is sometimes needed to correct wrong polarity; but if the windings of two A.F. transformers couple, they should be shielded or otherwise rearranged to correct the fault. The tuning of the aerial circuit on a short-wave set is especially important because of the usual low power of the received signal. The capacity (C3) used in that of the "Junk-Box" is obtained by a home-made device, such as amateurs have been using for years; but a factory-built variable may be easier to adjust with precision.)

CORRESPONDENTS WANTED

I would be glad to receive correspondence on making improvement to a Radiola No. 3A, especially as regards eliminating the four aerial posts on this set.

E. M. RYMER,
Canadian Corps of Signals,
9934 Ninetieth Avenue, Edmonton, Alta., Canada.

I would like to hear from any short-wave fan who has successfully built a two- or three-tube receiver and transmitter.

HARRY CULHANE,
170 Austin Street, Worcester, Mass.

There is knowledge to be gained in arguing, and I will gladly keep up a friendly argument by mail, and exchange ideas, on tubes and reproducers in general.

HERBERT COX,
2017 Pacific Ave., Atlantic City, N. J.

I would like to exchange ideas with any fans interested in S. W. reception.

LEON VINCENT,
Dannemora, New York.

I would be more than pleased if some one in South America, South Africa, or Australia, who is interested in short waves, would correspond with me. I will reply to all letters.

HILAIRE LE PROVOST,
722 Douglas Court, Clinton, Iowa.

I would like to correspond with others interested in short waves.

ERNEST K. WEAVER,
Box 1461, Fairmount, Illinois.

SPANISH PROGRAM FEATURES

Editor, RADIO NEWS:
The station mentioned in your November issue by Mr. John J. Hannigan, Jr., was undoubtedly PCJJ at Eindhoven, Holland, broadcasting a program for Buenos Aires and the rest of South America. This is a regular weekly feature from that station. On October 12, in commemoration of the discovery of America, a program was broadcast by that station for Spain and South America, including a message to the new president of Argentina.

In the same issue of RADIO NEWS I had the pleasure of reading a letter from the Rev. Richard H. Bell, S.J. While teaching in the University of Santa Clara, he made many important experiments and discoveries in the science of radio ("wireless" in those times) and physics. Very little credit

FERRANTI

Radio Products

Highest quality audio and output transformers for power and general purpose amplifiers.

Don't lose sight of the fact that the best audio amplifier can be rendered ineffective through the use of a poor output transformer or other amplifying device which falsifies or fails to transmit all frequencies.

Ferranti Output Transformers get the best out of your amplifier and speaker.

Type	Ratio	Speaker	Amplifier	Tube
OP-1	1-1	Magnetic	Standard	171-210
OP-2	25-1	Dynamic	Standard	171-210
OP-8 C	1.9-1	Magnetic	Push-Pull	171-250
OP-4 C	25-1	Dynamic	Push-Pull	171-250
OP-4 CC	25/50/1	Dynamic	Push-Pull	171-250

Technical data and prices sent on request.

FERRANTI, INC.

130 West 42nd St., New York, N. Y.
FERRANTI, Ltd. HOLLINWOOD ENGLAND
FERRANTI ELECTRIC, Ltd. TORONTO, CANADA

Write for this Discount Card NOW!

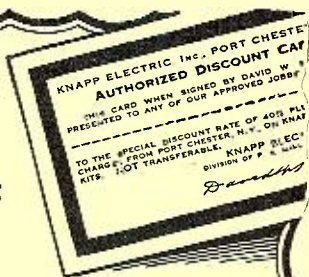

It will enable you to purchase the New and Improved

KNAPP "A" POWER KIT at a liberal discount

The new Knapp "A" is the finest and most complete kit ever offered. It is the only "A" Power adaptable to Short Wave—Super Heterodyne and Television reception.

Take advantage of the wonderful offer today—write

David W. Knapp, Pres.

Knapp Electric, Inc.

Division of P. R. Mallory & Co., Inc.

Room 417a, 350 Madison Ave., N. Y. C.

SOS.....

The Electric Word

Paul Schubert's new and fascinating book tells the gripping story of what lies behind the SOS call. The drama of modern radio from its beginning.

The Electric Word

The Rise of Radio

Just out—at all bookstores

MACMILLAN \$2.50

DEPENDABLE "B" BATTERY POWER

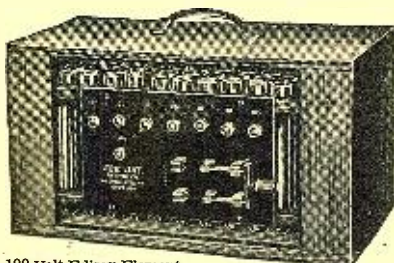

100 Volt Edison Element. Non-Destructive, Rechargeable "B" Battery with charger. Shipped dry, with solution, \$12. 140 Volt with charger, \$17. 180 Volt Power Unit, with Trickle Charger, \$24.00.
SEND NO MONEY—PAY EXPRESSMAN Write for our Free Literature
SEE JAY BATTERY CO., 915 Brook Ave., New York

SM DEALERS and SETBUILDERS

Complete stock of nationally known parts and accessories. Send for illustrated catalog and discount sheet.
Radio Exclusively Since 1921

CLARK & TILSON, INC.

192 CHAMBERS STREET NEW YORK
The Nationally Known House

More Profits To Set Builders

One good radio idea may be worth millions. Barwik has thousands of ideas for radio set builders to make more money. Barwik's Big Radio Book will help you while elections are on and big national events stir the world.
Send for your copy today—NOW!
22E Canal Station
BARWIK CO. CHICAGO, U. S. A.

Mail This Coupon Now! For Free Copy

Name

Address

has been given to Father Bell and I hope some day the full credit he deserves will be given to him; although I know very well he did everything just for the benefit of others, never seeking personal fame.

I would like to correspond with readers interested in radio. I will answer all letters.

ELIAS J. PELLET,
Calle de Goya, 42do, Madrid 9, Spain.

The Radio Constructor

(Continued from page 756)

ference which jams whatever one has been able to tune in after much struggling and juggling. However, for variety of programs Far Eastern broadcasting cannot be beat—that is, if you manage to tune them in—though, sad to relate, they are of several different languages; Chinese, English, Japanese, and others, including the variations in dialects among those mentioned.

However, in spite of these disadvantages, there are many enthusiasts who own radio sets and even have amateur transmitting sets; and I am pleased to state that some of your transmitting amateurs have been copied frequently over here, though reports of telephony reception from the States are somewhat rarer. It is interesting to note that European short-wave broadcasting like PCJJ, 5SW and some of the Siberian stations come in fairly well.

The local government is now erecting a broadcast station, and we hope to have a regular service in this little colony ere long. The greatest difficulty among amateurs here is their uneasiness in obtaining the necessary parts and apparatus for the construction of radio sets, because local dealers are very few in number and the demand for this particular supply is gradually increasing. The writer being a zealous amateur, is at present managing the radio department of The Sincere Company, Hongkong, and shall, therefore, be very glad if American manufacturers would furnish him with catalogs and general literature regarding radio supplies, installation and service; as he is convinced that a large demand will exist for sets and accessories when the local station begins operation.

H. C. FUNG,
The Sincere Co., Ltd., Hong Kong.

A LINEN-SPEAKER AERIAL

Editor, RADIO NEWS:

It may interest owners of linen-diaphragm speakers to know about a good indoor antenna, suggested by reading the article on the Loveless Antenna in the September issue of RADIO NEWS. I took 160 feet of bell wire, fastened one end to one of the rods, and took twenty turns around the speaker; then I covered this winding with cardboard and wound twenty turns over that. The free end of the inside coil is connected to the antenna binding post of the set, and the outside coil to the ground wire—no connection whatever to the ground binding post—and it works nicely. I am using a Splitdorf six-tube receiver and a Centralab tone amplifier, with horn working on six tubes and the linen speaker on seven; which gives the same volume from each, using a CX-371 tube in the set and a 301A in the tone amplifier.

H. B. HALL,
Bucksport, Maine.

LOVELESS, BUT NOT LUCKLESS

Editor, RADIO NEWS:

I see that many readers of this magazine are unsuccessful with the Loveless aerial. So was I, but the results did not discourage me. My set has posts for a short or a long aerial; so I connected the Loveless aerial to the long-aerial post, and my regular aerial to the short. The results were that stations came in with almost double volume. I have read your magazine for two years and I think it is the best on the market.

FRANK L. MAHER, JR.,
4460 West 133rd Street, Cleveland, O.

Editor, RADIO NEWS:

I have been reading your magazine for about four years, and can hardly wait for each issue. I notice that quite a few are trying the Loveless aerial with no luck. I am using one on a Majestic 72 and think it a wonder. I first tried it in the same room with the set with poor results; but, after putting it in the attic, I got wonderful results—much better than with an outdoor aerial.

LESTER WRIGHT,

1422 Erie Ave., Logansport, Indiana.
(The Loveless aerial was first described in RADIO NEWS for September, 1928; it was originally constructed on two forms, one 13 inches in diameter and the other 12 1/4, on each of which were wound 40 turns of bell-wire. An end of one winding

Over 1,000,000

Townsend "B" Power Units Now in Use -- they must be good!

They ARE good! Besides full tone, clarity and volume, you get the thrill of startlingly clear long-distance reception. Never in radio history has anything given such sensational results for such a low price. UNSURPASSED QUALITY built in with money saved by unified production methods and low merchandizing costs. New thousands of set owners learning amazing value of this Unit.

Utmost economy and convenience. Plug into light socket and forget it. Delivers up to 100 volts on any set on D.C. or A.C.—any cycle. YOU TAKE NO RISK. Sold on real GUARANTEE—it must satisfy or money paid us will be returned.

Complete
\$6.85
\$1.00 Down
Balance C.O.D.

SEND ONLY \$1.00 Fill in coupon and send with only \$1.00. Prove this marvelous value to yourself. Use it ten days. Then if it fails to do everything we say, return it and money paid us will be refunded. Make a REAL receiver of your set.

APPROVED

and passed by the rigid laboratory tests of "Popular Radio" and "Radio News."

From This Month's Mail

Have used your Eliminator for two years and it is as good as ever. I enclose check for another which is for a neighbor.
Jno. A. Green, Hulls, Ill.

My Eliminator has been in service for nearly two years and I want to thank you people for such an investment.
T. W. Hime, Nashville, Tenn.

Have had your Eliminator over a year and it has many higher priced ones beat.
Howard C. Toole, Bloomfield, Mo.

Eliminator I got of you about two years ago has given fine work.
Alfred Arndt, Emans, Pa.

Eliminator purchased from you over a year ago has given excellent service.
Walter L. Clark, Hidalgo, Texas.

Eliminator purchased from you more than eighteen months ago has given perfect satisfaction.
Leroy J. Myers, Washington, D. C.

The Eliminator bought from you about a year ago has been very satisfactory.
V. A. Johntgen, New Albany, Ind.

Eliminator is just fine. Have had much better service than with batteries.
Mrs. F. S. Partridge, Maryville, Mo.

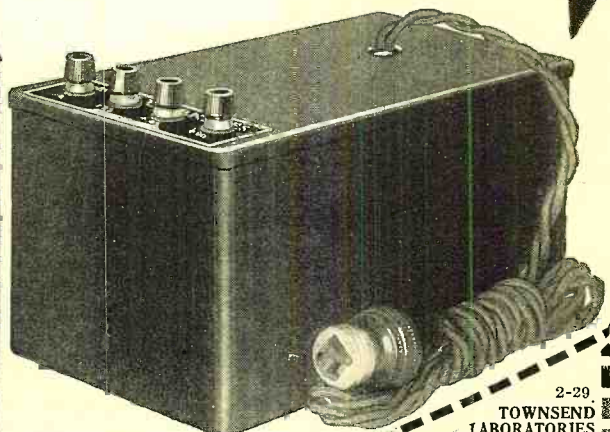

Attach only \$1.00 to this coupon

2-29
TOWNSEND LABORATORIES
Dept. 25,
713 Townsend St.,
Chicago, Ill.

Gentlemen: Attached find \$1.00. Kindly send at once Townsend "B" Socket Power Unit, C.O.D. \$5.95, plus postage, on guaranteed 10-day Free Trial.

Name.....
Address.....
City..... State.....

WRITE TODAY

Send for large, new illustrated Catalog "B-4," showing the latest of everything in radio at wholesale prices.

Allied Radio CORPORATION
711 W. LAKE STREET, CHICAGO

FREE TO SET BUILDERS AND DEALERS
NEW 100 PAGE CATALOG

HAMMARLUND OFFICIAL DISTRIBUTORS
SILVER - MARSHALL KIT HEADQUARTERS
NATIONAL COMPANY AUTHORIZED JOBBERS
AERO SHORT-WAVE AND DAVEN TELEVISION

We are ready to ship all kits or parts produced by the above manufacturers as well as any others specified in any radio publication.

31 Years of Service to the Trade
ROYAL-EASTERN PAYS THE FREIGHT
Lowest Wholesale Prices

Send for your copy of our catalog

ROYAL-EASTERN ELECTRICAL SUPPLY CO.
20 West 22nd Street, New York City, N. Y.

Please say you saw it in RADIO NEWS

Prices Slashed!

Order Today!

OFFER MAY BE WITHDRAWN IN THIRTY DAYS

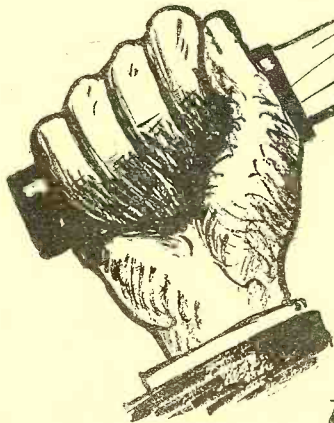

Your Favorite Magazines at Record-Making Reductions.

No. 30
(THE GRADE "A" SPECIAL)

AMAZING STORIES
RADIO NEWS . . .
SCIENCE & INVENTION

ALL 3
ONLY
\$5.75

YOUR CHOICE OF ANY ONE OF THE FOLLOWING:

RADIO NEWS 1 Year
OR
SCIENCE & INVENTION 1 Year
OR
AMAZING STORIES 1 Year
AND

ANY ONE OF THE OFFERS LISTED BELOW:

OFFER 1		ALL 3
YOUTH'S COMPANION 1 yr.	ONLY	\$5.25
PICTORIAL REVIEW 1 yr.		
OFFER 2		ALL 3
GOOD HOUSEKEEPING 1 yr.	ONLY	\$6.25
MODERN PRISCILLA 1 yr.		
OFFER 3		ALL 3
COSMOPOLITAN 1 yr.	ONLY	\$6.25
MODERN PRISCILLA 1 yr.		
OFFER 4		ALL 3
PICTORIAL REVIEW 1 yr.	ONLY	\$4.00
McCALL'S MAGAZINE 1 yr.		
OFFER 5		ALL 3
PATHFINDER 1 yr.	ONLY	\$4.40
MODERN PRISCILLA 1 yr.		
OFFER 6		ALL 3
AMERICAN MAGAZINE 1 yr.	ONLY	\$5.50
McCALL'S MAGAZINE 1 yr.		
OFFER 7		ALL 3
DELINEATOR 1 yr.	ONLY	\$4.50
MODERN PRISCILLA 1 yr.		
BIG FAMILY BARGAIN No. 29		
MOTHERS HOME LIFE 1 yr.	ALL 7 ONLY \$3.00	
ILLUSTRATED MECHANICS 1 yr.		
TODAY'S WOMAN & HOME 1 yr.		
HOUSEHOLD GUEST 1 yr.		
POULTRY TRIBUNE 1 yr.		
AMERICAN FARMING 1 yr.		

Offer No.	Both for only
8—AMERICAN BOY 1 yr.	\$4.00
9—AMERICAN MAGAZINE 1 yr.	4.50
10—BETTER HOMES & GARDENS 1 yr.	2.85
11—CHILD LIFE 1 yr.	5.60
12—COLLEGE HUMOR 1 yr.	4.00
13—COLLIER'S WEEKLY 1 yr.	3.75
14—COSMOPOLITAN 1 yr.	4.75
15—DELINEATOR 1 yr.	3.00
16—ETUDE (for music lovers) 1 yr.	4.00
17—EVERY CHILD'S MAGAZINE 1 yr.	3.50
18—FOREST & STREAM 1 yr.	4.00
19—GOOD HOUSEKEEPING 1 yr.	5.50
20—LITERARY DIGEST 1 yr.	6.50
21—McCALL'S MAGAZINE 1 yr.	3.00
22—McCLURE'S MAGAZINE 1 yr.	4.75
23—MODERN PRISCILLA 1 yr.	3.50
24—PATHFINDER 1 yr.	3.00
25—POPULAR SCIENCE MONTHLY 1 yr.	4.50
26—PICTORIAL REVIEW 1 yr.	3.00
27—SMART SET 1 yr.	5.25
28—YOUTH'S COMPANION 1 yr.	4.25

EXPERIMENTER PUBLISHING CO., Date.....
230 Fifth Ave., New York City.

Gentlemen: I am returning this coupon with \$..... for which I am to receive your OFFER NO. and

PUT X IN BOX
OPPOSITE YOUR
CHOICE.

RADIO NEWS 1 yr.
 SCIENCE & INVENTION . 1 yr.
 AMAZING STORIES 1 yr.

NAME
ADDRESS
CITY..... STATE.....

IF THE MAGAZINE YOU ARE INTERESTED IN IS NOT LISTED HERE, WRITE US FOR COMBINATION PRICE.

Please say you saw it in RADIO NEWS

was connected to the aerial post of the receiver, the opposite end of the other to the ground; and the smaller tube was slipped into the larger. The other ends of the windings were left open. The most contradictory reports have been received from readers; some have had good success, like the above, others absolutely negative results. It is evident that the device is very critical; a good many combinations and adjustments may be necessary to find the exact tuning of the aerial circuit to suit a given receiver and "location." It is therefore a purely experimental affair.—EDITOR.)

THAT GROUND QUESTION AGAIN

Editor, RADIO NEWS:

Having tried various "grounds" for receiving sets from wells to water pipes and from coils to sunken radiators, I find that the following serves me best. The parts required consist of a piece of 3/4-inch galvanized-iron pipe eight feet long, and some copper ribbon (such as is found in the old Ford car magneto and which may be procured for little or nothing from a Ford garage or auto parts junk man). This ribbon is covered with a shellacked paper, which may be easily removed after it is unwound by boiling in water for a few minutes. The copper is then sandpapered on both sides and is wound diagonally (like the handle of a golf stick) over the pipe, starting at the extreme end, and fastened either by a slot sawed in the pipe or by soldering or with a fine screw. The joint made by continuing the lengths of ribbon may either be soldered or fastened and may be hammered to follow the pipe closely. The upper end of the ribbon can be soldered, or it can be held by several turns of copper wire. The pipe can then be driven into the ground, until about one foot remains above the surface, and the ground wire from the receiver attached. In dry weather fill the pipe with water several times before using the set and you will have a ground which cannot be improved upon, in my experience.

A. D. DRAPER, M.D.
5609 Florida Ave., Tampa, Fla.

BED-SPRING AERIALS

Editor, RADIO NEWS:

I think your magazine is about the best radio book I have ever read. I have a two-tube set using dry-cell tubes with which I experienced some odd results. I had a 5-foot inside aerial and a ground which had a 60-foot lead before reaching the earth connection. Good results were unobtainable with this combination, so I ran a short length of wire from my receiver to my bed-spring. After doing this I brought in the following stations during one afternoon: WEAF, WLW, WJZ, WJR, WBBM, CFCA, CKOC, KDKA, WHEC, CKWC, WMAQ, WCCO, WGN, WRAL, and a good many locals. I would like to hear from other listeners who get good results with small sets. I get the coast almost every night during the winter months after the locals have signed off.

ARTHUR GOULD,
216 Comstock Avenue, Buffalo, N. Y.
(Mr. Gould failed to state to what part of the circuit he attached his bed-spring. Using the bed-spring as an aerial has been known to the amateur transmitting fraternity, who made use of this stunt during the late war when external aerials were sure to attract a platoon of Department of Justice agents bent upon confiscating whatever radio apparatus they could lay their hands on. However, the bed-spring is not recommended as a panacea for antenna ills.—EDITOR.)

FOR BETTER TONE

Editor, RADIO NEWS:

For the past five years I have read every experimenter's communication to your magazine, and have built every set and tried out every gadget that my purse would allow; but it astonishes me that the craze for power amplifiers, down here, has not spread more among your correspondents. So many of your communications use such superlative expressions as "de luxe reception" as applied to 112 output tubes and obsolete speakers, that I wonder if you do not practice some sort of selection of the material appearing in your radio constructors' department.

The results of most of my radio-frequency experiments were nothing to get feverish about, because the added stations were not worth listening to, on account of the general noise level, even if brought in. On the other hand, my expenditures for power amplification were always profitable because they improve any set. I happen to use right now a 250-type three-stage amplifier built of General Radio standard parts, but my friends have built similar amplifiers from equivalent units appearing in the advertising sections of every issue of your publication, with equal success. Fans down here are about evenly divided on the merits of the

THE SET THAT'S SWEEPING THE COUNTRY

The Philharmonic 8 Tube All Electric Radio!

REGULAR PRICE OF OUTFIT \$148.00

Now Offered Direct to Set Builders, Amateurs, Experimenters

AT HALF PRICE

YOU PAY 79.50 COMPLETE

NOTHING ELSE TO BUY

All Standard Merchandise Read These Specifications:



Set is 19 1/2" x 12 1/2" x 8 1/2". Table is 25" high. Speaker is 19" in diameter.

HERE IS WHAT YOU GET:

- 1 Philharmonic 8-Tube, AC Electric Receiver..... \$ 75.00
- 1 Beautiful Findlay Art Metal Table..... 20.00
- 1 Famous Tower Castle Cone Speaker..... 25.00
- 8 Genuine Magnatron Tubes (5-226, 1-227, 1-171a, 1-280)..... 24.00
- 1 Complete Aerial Kit and Voltage Regulator..... 4.00

Total Value of Complete Outfit..... \$148.00
You save \$68.50 and pay us only \$79.50.

ALL READY TO PLAY—JUST PLUG IN LIGHT SOCKET

ALLENJAY ELECTRIC COMPANY
272 LAFAYETTE STREET, NEW YORK, N. Y.

SEND \$19.50 WITH ORDER, PAY BALANCE ON DELIVERY

FREE TRIAL IN YOUR OWN HOME—Buy the set and hear it in your own home for five days. If, at the end of that time, you do not think it comes up to your fondest expectations, return it to us and we will return your money promptly.

THE SET—THE PHILHARMONIC 8-TUBE ELECTRIC SET is built like a jeweled watch. It is especially designed for ease of operation (one illuminated dial). It is sensitive and selective, having four condensers, a feature found only in more expensive sets. Its tone is natural—even human in its rendition. It has a built-in phonograph pick-up, for the playing of phonograph records electrically through the radio set. As sturdy as an oak—yet as handsome as can be. Its ruggedness is concealed in a beautiful metal cabinet. It is simple enough for a child to operate—yet radio engineers proclaim it a marvel of design for local and distance reception. The Philharmonic is one radio you will be proud to own, for it never fails—you get the program you want, when you want it.

THE SPEAKER—Manufactured by the Tower Manufacturing Company, who have been making electrical apparatus for years. The CASTLE CONE SPEAKER is a work of art, a picturesque mediaeval castle with embattled turrets cast in relief and furnished in two-tone bronze. The new type super-powered armature drives a seventeen-inch free-edge cone protected by a metal rim. This speaker is especially adapted for power tube amplification, producing exceptional quality of reproduction. Height 19 inches.

THE TUBES—Manufactured by the oldest and largest independent tube company. Guaranteed to give at least one thousand hours' continuous service.

THE TABLE—This table reflects beauty and taste. It is finished in antique bronze with dashes of black, the whole outfit is perfectly matched and harmonizes with any surrounding.

Shanco Battery Clip
GRIP-TITE POWERFUL TENSION

THE Shanco Battery Clip design assures free and uninterrupted flow of electrical current. No springs to heat up, burn or drop out. Made of powerful tension, tempered spring steel solidly riveted together. All parts electroplated before assembly (not galvanized or tinned), acid-resisting. Jaws open wide and are easily applied. The Griptite bulldog teeth "stay put" and bite right through corroded bars and terminals. Clip cannot fall over and "short" your battery.

Write Dept. 74 for free literature and prices.
SHANKLIN MANUFACTURING CO.
Dept. 75, Springfield, Illinois

SET BUILDERS
Get this Book

LATEST RADIO GUIDE FREE

Barawik, the first and oldest radio specialty house, offers you unusual service this year. Bigger stocks, quicker shipments, lower prices. Deal with an old established, reliable house. Get honest goods, honest service, honest prices. Barawik service makes you more money. Send now for big new Catalog showing lowest wholesale prices.

BARAWIK CO. 22K Canal Sta., CHICAGO, U. S. A.
Mail This Coupon Now for Free Radio Guide

Name _____
Address _____

Insure your copy reaching you each month. Subscribe to Radio News—\$2.50 a year. Experimenter Publishing Co., 230 Fifth Avenue, N. Y. C.

Please say you saw it in RADIO NEWS

Radio HEADQUARTERS

The newest radio wrinkles—A-C, grid tube, short wave, television, dynamic speakers, newest tubes and circuits—anything and everything in radio—are now ready for you at Barawik's. With inaugural, football, National broadcasting, Roxy and other big doings filling the air, thousands of newcomers will take to radio this year as never before. Business will be good—Set builders will make money. You can clean up big by buying from Barawik—the oldest, biggest, most reliable radio house in the world. Let us prove it. Send now for the Big Book—all ready for you—free. Get the latest radio information and lowest prices.

BARAWIK CO.
12 B CANAL STA.,
CHICAGO, U.S.A.

This Big Book Sent to You Free



Name.....
Address.....
City.....

BUILD YOUR OWN Exponential Horn

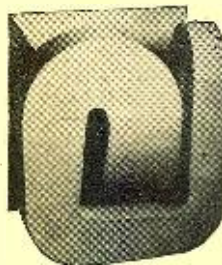

This marvelous 17x21-in. exponential horn with a 96-in. air column can be easily built of 3/4-in. soft wood by any amateur. It produces the most wonderful tone quality. We furnish you with a set of FULL-SIZED PATTERNS, which have been accurately and scientifically worked out according to the exponential principle. Simply saw out the wood to the size and shape of the patterns and nail and glue together and you have a

TONE PRODUCER EQUAL TO THE BEST ORTHOPHONICS

Send \$2.00 for a set of these full-sized patterns and complete instructions, or we can furnish you the COMPLETE KIT, which includes the wood cut to fit, the nails, the glue, our large-sized CONCERT UNIT, and full instructions. All complete with postage prepaid for \$11.75 in the United States and \$12.75 in Canada.

RADIO PRODUCER COMPANY

1245 Jefferson Bldg.

Peoria, Ill.

Before Buying Any "A" Eliminators

Write me about the discount card which enables you to purchase the new and improved Knapp "A" Power Kit at a liberal discount.

The most complete "A" Power Kitever offered—Address for details of plan—

David W. Knapp, Pres.
Knapp Electric, Inc.

Room 417a, 350 Madison Ave., N. Y. C.

MASON, FENWICK & LAWRENCE PATENT LAWYERS

600 F. ST. N. W., WASHINGTON, D. C.

ESTABLISHED OVER SIXTY YEARS—SEND SKETCHES Electrical and Chemical Inventions Carefully Handled. Practice before the U. S. Courts and the Patent Office.

Prompt and Careful Service Trade-Marks Registered

Print Your Own
Cards, Stationery, Circulars, Paper, etc. Save money. Print for others, big profit. Complete outfits \$3.85. Job press \$11. \$29, Rotary \$149. All easy, rules sent. Write for catalog presses type etc. THE KELSEY CO., P-72, Moridon, Conn.

large, exponential horn and dynamic speaker, myself favoring the latter. The relative merits of the new "Clough-system" transformers, and the Hiler tuned double impedances are being hotly debated, and experimented with. Television is not a live issue here, yet. But electric pickups are quite the thing.

I would like to hear from fellow experimenters who have been through the mill in respect to radio-frequency circuits, short waves, buried antennas, etc., to learn their success in experimenting with real quality amplifiers and speakers. I know of no more fascinating study than the struggle to attain perfect tone realism.

ARTHUR SMITH,
1107 Franklin St., Tampa, Fla.

(Mr. Smith, whose letterhead shows that he is a music dealer as well as a radio experimenter, naturally puts more importance upon tone quality than do many of our DX fan correspondents. However, it cannot be gainsaid that the latter in many instances are studying the problem of high signal amplification with an eye to economy rather than an ear to the finest reproduction. And then, perhaps, the easy manner in which many are satisfied indicates that they have not cultivated an expert sense of musical value. "Absolute pitch," we understand, requires also natural gifts of an unusual nature. However, "every man to his taste." —EDITOR.)

BLUEPRINTS ARE IN DEMAND

Editor, RADIO NEWS:

I have just completed the "Combine" receiver a few days ago and am getting good results with it. I have built a number of receivers from your blueprints so far, with really good results; the others are the "Junk-Box," the "Milk-Shaker Special" and the three-tube screen-grid short-wave receiver. So I say, many thanks for the blueprints.

B. E. POWELL,
Motor Route A, Fort Wayne, Indiana.

(RADIO NEWS will endeavor to present the types of set most favored by constructors in its blueprint articles. The number of these which can be published is limited, of course, and careful design is necessary to bring each set to the required efficiency before it can be published. Then a great deal of draughting on the plans is necessary before blueprints can be prepared. For this reason, readers who write in for a blueprint of a set embodying this or that feature according to their own material on hand must be often disappointed. Constructional details of such sets cannot be provided as requested; nor can we furnish layouts or blueprints of any commercial sets. In the scope which our blueprints can cover, however, we are endeavoring to render the greatest service to the greatest number of readers.—EDITOR.)

A RADIO THEATRE

Seats for 1,000 visitors will be provided in the largest studio of the British Broadcasting Company at London. The building, which is to cost \$2,000,000, is now scheduled to be completed in 1930, and will contain nine studios, one for picture transmission.

A JIBE FROM THE ARID WEST



The Want-to-Know editor is always preaching to us about the value of moist ground if we want DX reception. It is evident that some enthusiasts want to bring it right into the set, from an advertisement which appeared in the Radio World of September 8: "Antenna coupler, with MUD-TAPPED aperiodic primary." We suppose that the grid leaks are piped to it to keep it wet.

Frank J. Falkner.

IF WE ONLY COULD!

If we only could follow these directions by Mr. Crosley in *Simplicity of Radio*, 1928 edition, how we would shake some of these sopranos and give the bedtime story-teller what-for—"Turn the STATION SELECTED slowly—" But we have only the ordinary length of arm, and some of these DXers are safely out of our reach.

—Walter Hawkins.

SAVE YOUR MONEY! BE YOUR OWN SERVICE MAN

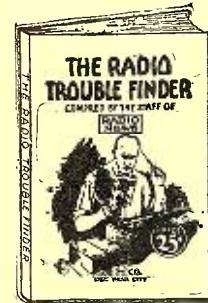

THE RADIO TROUBLE FINDER

Even the highest-priced radio set occasionally develops a fault and that at a time when you least expect it—maybe right in the middle of an interesting program. But, a handy copy of

The Radio Trouble Finder is the simple means for tracing every defect and remedying it in the easiest manner possible. There is no mishap that could befall a radio, but what is fully covered in this valuable book.

The Radio Trouble Finder is edited by men fully versed in the subject covered—men with years of actual experience behind them—and who have grown to prominence since the infancy of radio.

Don't wait till your set goes bad—get your copy of this remarkable guide to radio trouble now. Fill in the coupon and we will send you by return mail a copy of *The Radio Trouble Finder*, a money-saving investment. You can be your own service man.

The **25c** Copy

BUILD YOUR OWN RADIO SET

150 RADIO HOOK-UPS



This is the latest issue of this remarkable book. Absolutely new and up-to-date. All the best circuits of the day. Full instructions on how to build. Make your own set from the diagrams shown in 150 Radio Hook-Ups.

Write today—pick the set you want to build and make it. Then you are sure to be satisfied with the results you get.

150 Radio Hook-Ups was prepared by the staff of Radio News. An accurate guide to better set construction for the radio "fans."

The **25c** Copy

MAIL THIS COUPON NOW

CONSRAD CO., INC.
230 FIFTH AVENUE NEW YORK, N. Y.

CONSRAD COMPANY, INC.
230 Fifth Avenue, New York, N. Y.

Gentlemen:
Kindly send me a copy of 150 RADIO HOOK-UPS... THE RADIO TROUBLE FINDER... (check which or both).
Enclosed find.....cents in full payment.

Name.....
Address.....
City..... State.....

Please say you saw it in RADIO NEWS

Radio News Laboratories

(Continued from page 755)

The "Type RX-171A," submitted by the same manufacturer, takes a maximum plate voltage of 180 volts. Its dynamic characteristics are, voltage amplification 3; A.C. plate impedance 2,000 ohms; mutual conductance 1,450 micromhos. This tube is equipped with the standard UX base and requires ¼-ampere filament supply at 5 volts; its operation as a power output tube is satisfactory.

AWARDED THE RADIO NEWS LABORATORIES CERTIFICATE OF MERIT NO. 2513.

The "Type RX-227" tube of the same manufacturer has a cathode indirectly heated by an A.C. filament; its dynamic characteristics are voltage amplification 8.1, plate impedance at 135 volts 9,800 ohms; mutual conductance 810 micromhos. This tube requires a heater current of 1.75 amperes at 2½ volts; the maximum recommended plate voltage is 180. It is supplied with the "UY"-type five-prong base.

AWARDED THE RADIO NEWS LABORATORIES CERTIFICATE OF MERIT NO. 2514

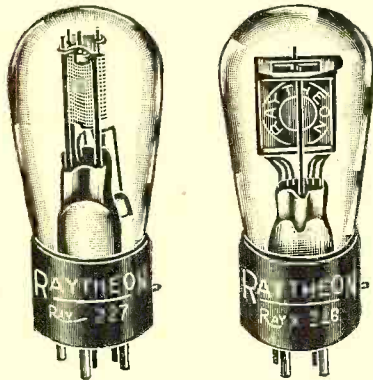

The "Type RX-226" vacuum tube of the same manufacture is of the A.C.-filament type, requiring 1½ volts at 1.05 amperes; the dynamic characteristics are, amplification constant 8.3; A.C. plate impedance at 135 volts 7,500 ohms; mutual conductance was found to be 1,050 micromhos. The standard four-prong UX base is used.

AWARDED THE RADIO NEWS LABORATORIES CERTIFICATE OF MERIT NO. 2515.

WHILE SOME GO OUT AFTER IT!

Apparently unnecessary invention described by the *Scranton (Pa.) Sun* of September 6: "The accessory, known as a pretuner, will, according to the inventor, TROUBLE the power and volume of a set." You can't sell us one at any price: our neighbor on the right has a violet-ray machine and the one on the left a vacuum cleaner.

—Charles J. Pickard.

40 Non-Technical Radio Articles

every month for the beginner, the layman and those who like radio from the non-technical side.

SCIENCE AND INVENTION, which can be bought at any newsstand, contains the largest and most interesting section of radio articles of any non-radio magazine in existence.

Plenty of "How to Make It" radio articles and plenty of simplified hook-ups for the layman and experimenter. The radio section of SCIENCE AND INVENTION is so good that many RADIO NEWS readers buy it solely for this feature.

Radio Articles Appearing in
February SCIENCE AND
INVENTION Magazine

THE RADIO ALTIMETER
DYNAMIC SPEAKERS
NEW RADIO DEVICES
RADIO ORACLE
RADIO WRINKLES
LATEST PATENTS



Blast your way through...

with the super powered

HFL SPECIAL NINE*

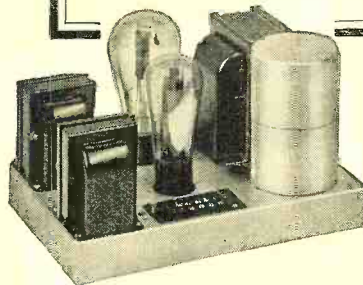

it will stay sold. It's a five year set, allowing short wave operation and excellent reproduction of television signals. The Special Nine is years ahead of everything else in the radio field. And it's priced right, too—

	List Price	Net Less 40 & 2%
D C Chassis—9 tube	\$ 95.00	\$55.86
A C Chassis—8 tube (250 external)	105.00	61.74
Set builder's wiring charge for either set	30.00	17.64
250 Power Amplifier and B supply, factory wired	77.00	45.28

Prices are without tubes. The A C set requires the 250 power amplifier and B supply for operation. The power amplifier will also operate with and furnish plate voltages to the D C Special Nine.

Wide awake set builders! Attach coupon to your business stationery and send for our new plan showing how to sell at low prices and make large profits. Mail the coupon TODAY. Grasp this golden opportunity NOW!

If you have mailed a previous coupon to the High Frequency Laboratories, please do not mail this one, as you will automatically receive complete information.

HIGH FREQUENCY LABORATORIES
Office 10, 28 N. Sheldon St. Chicago, Ill.

HIGH FREQUENCY LABORATORIES
Office 10, 28 N. Sheldon St., Chicago, Ill.
Gentlemen: Without obligation please send literature describing the H F L Special Nine, also the new 250 Power Amplifier and B Supply. I have never mailed a coupon to you before.

Name _____
Address _____
City _____ State _____

(Please print plainly)
Not a kit of loose parts, but a factory assembled *chassis ready for wiring. Screen grid amplifier wired and tested.

HFL

This Wholesale Catalog Will Save You Money
Write today for our large illustrated new Catalog "B-4," showing how this organization of men with years of experience in Radio can give you personal service.

Allied Radio CORPORATION
711 W. LAKE STREET, CHICAGO

PATENTED
SENSATION OF THE NATION
POLK
BINDING POST
15 Cts. Each
Insulated. No holes to fish for. Insert wire in any position. Quick action and holds tight. Standard markings.
J. L. POLK
41 Belle Ave. TROY, N. Y.

Insure your copy reaching you each month. Subscribe to Radio News—\$2.50 a year. Experimenter Publishing Co., 230 Fifth Avenue, N. Y. C.

Please say you saw it in RADIO NEWS

Short Wave Manual

New Full size blue prints bound in book

ONLY 50¢
THE 50 COPY

Up-to-the-minute data—All worthwhile circuits—

Prepared by Eminent Short Wave Experts

Edited by H. M. BAYER, Tech. Editor of RADIO NEWS

This is unquestionably the foremost book on short wave receivers and the theory of short wave reception ever written. The data which it contains is a compilation of the knowledge of an eminent board of Short Wave Experts.

As practically every one today knows, some of the finest programs are being broadcast over the short wave bands. There are many reasons for this. Paramount among them all is the fact that that entertainment, broadcast in this band, can be received over distances which with the ordinary broadcast receiver would be impossible! Thousands of letters, which pour in an unremitting stream into our offices tell the same tale—it is a common and everyday matter to receive programs



EXPERIMENTER PUBLISHING COMPANY, Inc.
230 Fifth Avenue, New York

Beautiful Colored Cover

from all foreign countries, from the most distant climes. England, France, Germany, towns on the African continent, from every conceivable corner of the globe where a station is located—programs come in with surprising volume and clarity. One would think they were hearing a New York, Chicago or San Francisco station until the voice of the announcer, many thousands of miles away discloses the true location of station.

In the Short Wave Manual you will find complete diagrams, full size blueprints pasted into the book. These tell plainly how to construct all the short wave circuits which our tireless laboratory researches have shown to be most efficient.

The SHORT WAVE MANUAL contains complete information on everything concerning Short Wave reception. Large size book (same size as Radio News) with a beautiful colored cover. Replete with illustrations, diagrams and with FULL SIZE BLUE PRINTS. This big valuable book will show you how to receive all the foreign countries clearly and easily. Write today for your copy.

Mail This Coupon

EXPERIMENTER PUBLISHING CO.
230 FIFTH AVENUE, NEW YORK.

Gentlemen:

Enclosed find 50c for which please send me a copy of THE SHORT WAVE MANUAL.

Name

Address

City State

Please say you saw it in RADIO NEWS

I Want to Know

(Continued from page 758)

though we have used care to prevent this. The answer to the riddle is that there is a feed-back through the common plate-voltage supply. The reason why we encountered this feed-back will be explained later, but let us look first at the diagram (Fig. Q2326A). This shows the insertion of choke coils CH in series with each of the plate leads and the screen-grid leads, as well as in the grid-return wires. This is the correct construction for getting

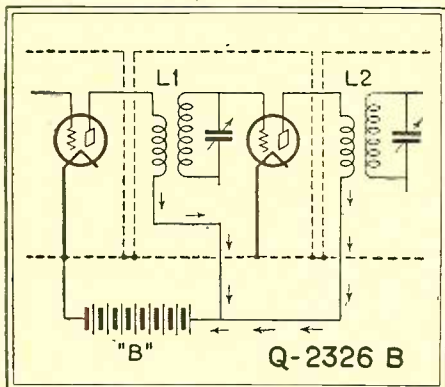

Any resistance in two different circuits at once causes coupling between them. A "B" battery may act in this way.

the highest efficiency from the screen-grid R.F. amplifier. Now we will explain why these chokes are used.

Battery Coupling

Figure Q2326B shows a radio-frequency amplifier simplified so that we can more easily follow the circuits in question. The plate wires are connected to a common battery "B," which places the necessary positive potential on the tube plates. This method of operating the tubes would be quite satisfactory if the battery or power unit did not possess any resistance or impedance. The well-known Ohm's Law tells us that, when a current flows through a resistance, a voltage is set up which is equal to the product of the resistance and the current. Referring to the figure, it will be seen that an R.F. current is set up, due to the impedance of the power supply, and this current is then introduced into the plate circuits of these tubes; which provide a coupling, in spite of all our precautions in shielding the set.

Since we have now discovered the cause of the trouble in our set, it is necessary to find some way to prevent the interaction thus caused. The simplest way is to place radio-frequency choke coils in

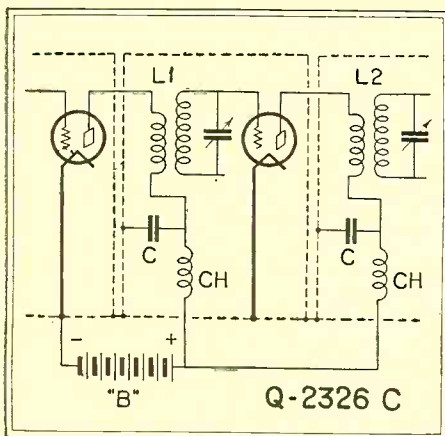

Chokes in each plate lead, following by-pass condensers, prevent battery coupling. While this is good practice with any receiver, it is absolutely essential with screen-grid circuits because of their high sensitivity.

each of the leads which might cause trouble in this matter. The choke coils will restrain the currents from flowing in the incorrect paths, and by connecting also condensers of suitable capacity between the circuit in question and the filament wiring, we will provide a low-impedance return path for the radio-frequency currents. Because of the

AERO S. W. GETS EVERYTHING England Every Day Australia on Thursdays Holland on Fridays

"It may be of interest to you to know * * * that 5SW (Chelmsford, England) has been received every afternoon * * * since March 19th * * * PCJJ at Eindhoven, Holland, comes in every Friday from 7 p. m. to 11 p. m. * * * 2NM at Caterham, England, on Sundays, Wednesdays and Fridays. * * * PCLL at Kootwijk, Holland, about three days a week. Listened to 2FC at Sydney, Australia, from 6:30 a. m. to 7 a. m. Thursday morning. * * *"

—From letter received from a Pennsylvania "Aero" owner.

The magic of short waves and their fascinating possibilities for reception over great distances are bringing many new enthusiasts into this field of radio reception. Besides the lure of distance, the broadcasting of television on short waves is becoming daily more and more wide-spread and the fact that there is no day or night, or winter or summer, as far as short wave signals are concerned, has meant that in many regions where daytime reception has never been satisfactory and summer reception poor, stations can now be received with good volume and clarity at any hour of the day, any time of year.

There are many who have been attracted by these tremendous possibilities but who for reasons of space or economy have not felt themselves able to keep two receivers—one for short waves and one for the regular

broadcast band. For these we offer the Aero Standard Short Wave Converter.

This little device is entirely built on a panel seven by ten inches. It is simple to construct and very low in cost. It requires no batteries other than those already in use on the receiver and it requires no connections to the batteries other than those taken from a single tube base which can be put in the broadcast receiver in place of the detector tube. It can be used on either A. C. or D. C. sets.

To make the construction of these outfits as simple as possible, Aero Products, Inc., supply them with the sub-panels completely wired, leaving necessity only for the connection of seven wires by the builder and the mounting of a few pieces of apparatus on the already drilled panel.

INTERNATIONAL S. W. CONVERTER



Will add thousands of miles to your receiving range. Broadcast reception on short waves is remarkably clear and free from static. Programs are brought in from greater distances with utmost ease. Build the Aero and receive short-wave programs on your present set. No changes in wiring necessary. Just plug into detector socket.
Kit No. 9—
Price \$38.90

STANDARD S. W. RECEIVER

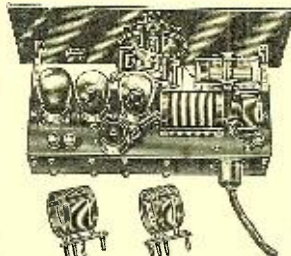

A three-tube short-wave receiver of the standard time-proven regenerative type, brought to its greatest perfection. New improved Aero Interchangeable Coils assure maximum selectivity and sensitivity. Either for A. C. or D. C. Tubes.
Kit No. 10 For A. C. \$49.95
Tubes—Price
Kit No. 11 For D. C. \$49.95
Tubes—Price

STANDARD S. W. CONVERTER



No extra tube is needed. Plug into detector socket of your receiver and insert the tube which you removed from set into the Converter. Kit is complete with all parts. Can be assembled in a few minutes.
Kit No. 12 For D. C. \$32.00
Tubes—Price
Kit No. 14 For A. C. \$32.00
Tubes—Price

Get the Big Green Book—Mail This Coupon Now

Aero Products, Inc., 4611 E. Ravenswood Ave. Dept. 11, Chicago, Ill.

Please send me a copy of your 25c Aero Green Book showing 64 pages of newest modern circuits for short wave and broadcast receivers, transmitters, coils and kits.

Name
St. & No.
City State

AERO PRODUCTS INCORPORATED

4611 East Ravenswood Avenue
Dept. 11, Chicago, Ill.

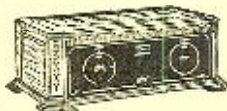

T. R. F. CIRCUIT

5 TUBE SETS \$14.90

IN BEAUTIFUL WALNUT CABINETS
THE MOST ASTOUNDING OFFER
EVER MADE IN RADIO
Guaranteed for Tone Quality and Selectivity

If, after trying out one of these sets, you do not feel that this is the MOST WONDERFUL BUY you ever saw in a radio set, we will cheerfully refund your money in full. These sets were taken in trade by dealers for all electric sets. The dealers, having been loaded with these used battery operated sets, Liquidated. We purchased them for spot cash at a tremendous sacrifice. Therefore, the reason for the ridiculously low price we quote. All sets tested before we ship, and guaranteed perfect. Orders will be filled in the order that we receive them. Send money order with order.

ACT AT ONCE Set of 5 Tested Tubes with Set \$2.00

Attention Dealers! Turn to page 798, Classified Section, Radios & Supplies column, and see our prices on bankrupt stocks of radios and parts.

CHAS. HOODWIN CO., Dept. M., 4240 Lincoln Ave., Chicago, Ill.
DEALERS IN BANKRUPT STOCKS

Please say you saw it in RADIO NEWS

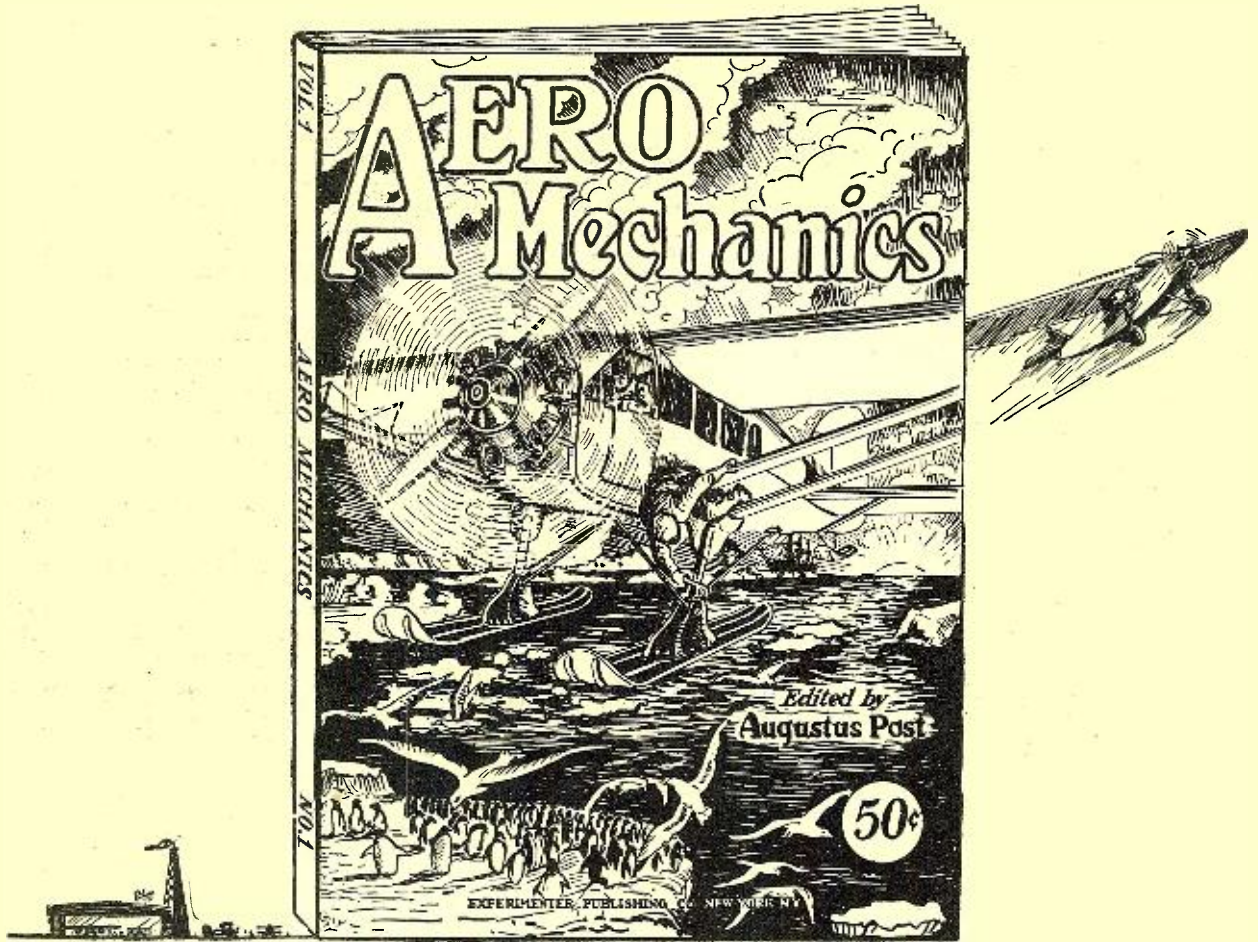

AERO MECHANICS—THE BOOK OF THE AGE

The greatest book on modern aviation ever published. The many ramifications of the aeronautical field that it covers can be better appreciated by a glance at a synopsis of its contents.

CONTENTS IN BRIEF:

- Theory and Fundamental Principles of Flight.*
- Stability—How an Aeroplane Flies.*
- Complete Design, Construction and Assembly.*
- Scale Drawings—Names of Parts.*
- Flying Instructions—How to Become a Flyer.*
- Motors—Latest Inventions—Instruments, Use and Function.*
- Radio Installations.*
- Gliders.*
- Airports and Lighting.*
- Glossary of Aeronautical Terms.*
- The Aeroplane Mechanic.*
- Model Making.*



MR. AUGUSTUS POST
Editor of AERO MECHANICS

Mr. Augustus Post, editor of *AERO MECHANICS*, has been prominent in aeronautical circles throughout the country for over twenty years, his experience and adventures have made aviation history and placed him in a position to pass on to the readers of *AERO MECHANICS* honest, accurate and entirely dependable information on every phase of Aviation. Says the *North American Review* of Mr. Post: "No man in America has been more continuously at the centre of aeronautic activities in this country, and in touch with more history-making airmen here and abroad, than has Augustus Post who, besides having the "history of the air" in his head, has personally participated in some of the most thrilling adventures of aviation."

AERO MECHANICS, written by Augustus Post, is the most complete treatise of its kind ever published. It deals with every phase of aeronautical construction and operation, and its entire contents is passed upon by Mr. Post, who is one of the best known pioneers of aviation. Learn all about this great new field. Obtain your copy of *AERO MECHANICS* today. Over 112 pages. Fully illustrated. Large 9" x 12" size.

THE 50c COPY
At All Newsstands, or Write Direct
Experimenter Publishing Co., Inc.
230 Fifth Avenue, New York City

EXPERIMENTER PUBLISHING Co., Inc.
230 Fifth Ave., New York City, N. Y.

Gentlemen:
Enclosed find 50c, for which please send me a copy of your remarkable new book, *AERO MECHANICS*.

Name

Address

City..... State.....

Please say you saw it in *RADIO NEWS*

chokes, they will not noticeably affect the "B" supply. Fig. Q2326C shows how the choke coils and condensers would be introduced into the circuit of Fig. Q2326B. The chokes should be of the usual R.F. design, with an inductance of about 60 millihenries or up to 125; and the condensers have a capacity of one-quarter microfarad, or even more.

The same system of isolation is applicable to all other circuits involved, both control-grid and shield-grid, as well as the plate. To follow through, we must then isolate each individual circuit by the condenser-and-choke arrangement; this is shown in the first diagram, Fig. Q2326A.

The manufacturers of the screen-grid tube recommend the use of a special shield on each tube and also the shielding of the grid and plate leads. This is especially important when the plate or grid wiring is run from one stage to another. A metal tube placed over the wires is shown as shielding the plate leads, Fig. Q2326A; this tube should extend directly from the plate terminal on the tube socket to the terminal of the coil in the succeeding shield. It must be grounded very carefully to the common shield connection, in the manner described above.

AMATEUR LICENSES

(2327) Mr. C. D. Nelson, Caldwell, N. J., asks:

(Q.) "Is it possible for you to supply me with information for obtaining an amateur license? What are the requirements for such a license and where is application made? Any information that you can give me will be greatly appreciated."

(A.) The prospective amateur should forward an application for a license to the Supervisor of Radio for the district in which he resides, as shown below. This application will bring a letter of instructions; from which the applicant will learn that he must be able to read the International Morse code at a speed of ten words or more per minute and also that he must pass a written examination covering the theory and practical operation of the transmitter and receiver to be used. He will also learn that he must obtain a copy of the Radio Communication Laws and Regulations of the United States, and study carefully the regulations relating to amateur operators. A copy of these regulations may be obtained at a cost of 15 cents (not in stamps) from the Superintendent of Public Documents, Government Printing Office, Washington, D. C.

The regulations mentioned contain a copy of the code; and a considerable amount of time must be devoted to learning this code before further steps are taken to obtain the license. An article explaining several methods of learning the code will be found in the August, 1928, issue of RADIO NEWS. In order to obtain the necessary information on the theory of radio and the operation of transmitters and receivers, it will be necessary to refer to textbooks and periodicals. The Signal Corps handbook entitled "The Principles Underlying Radio Communication" is a very good textbook on the theory of transmission; this book can be obtained from the Government Printing Office and is priced at \$1.00.

The vacuum tube is used in all amateur transmitters now, and this point should be particularly stressed. As soon as the applicant is sufficiently confident that he is capable of passing the code test and the theory test, he should make an appointment for personal examination at the office of the Supervisor of Radio for his district. These districts are as follows:

First District: Maine, New Hampshire, Vermont, Massachusetts, Rhode Island and Connecticut. Address Supervisor of Radio, Custom House, Boston, Mass.

Second District: New York, (New York City, Long Island, and the counties on the Hudson River up to and including Schenectady, Albany and Rensselaer) and New Jersey (counties of Bergen, Passaic, Essex, Union, Middlesex, Monmouth, Hudson and Ocean). Address Supervisor of Radio, Sub-Treasury Building, Pine and Wall Streets, New York City.

Third District: New Jersey (all counties not included in second district), Pennsylvania (counties of Philadelphia, Delaware, all counties south of the Blue Mountains and Franklin County), Delaware, Maryland, Virginia and the District of Columbia. Address, Supervisor of Radio, Custom House, Baltimore, Maryland.

Fourth District: Tennessee, North Carolina, South Carolina, Georgia, Florida, Alabama, and the Territory of Porto Rico. Address Supervisor of Radio, Room 524, Post Office Building, Atlanta, Georgia.

Fifth District: Mississippi, Louisiana, Texas, Arkansas, Oklahoma and New Mexico. Address Supervisor of Radio, Custom House, New Orleans, Louisiana.

Sixth District: California, Nevada, Utah, Ari-

Radio's greatest value! SUPERPHONIC

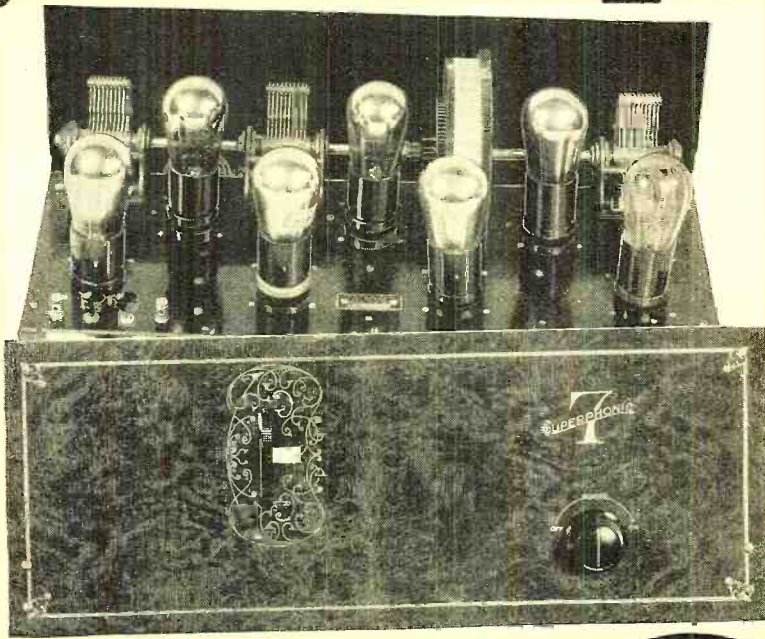

7 Tubes—Single Dial

Superphonic 7 is a world beater! An exceptionally high grade receiver that is amazing the Radio World. Latest 7-tube tuned radio frequency circuit, using 4 radio frequency amplifiers, detector and 2 stages of audio. Power tube can be used in last audio stage. Extremely selective, marvelous sensitivity. Single drum dial control. Straight line wavelength condensers permit accurate, equally spaced tuning over entire wave band. All sockets spring cushioned to eliminate microphonic noises. Bakelite subpanel (3 1/2" deep) insures minimum dielectric losses. Clear and realistic reception guaranteed. An exceptionally beautiful, walnut finish, metal front panel 7 1/4 x 13 7/8". Complete chassis. No extra parts to buy. All parts mounted ready to wire. No special tools needed. All hook-up wire and colored battery cable included. Value \$60.00; our price \$16.95.

TESTED AND APPROVED

Severe laboratory tests have proved the remarkable efficiency of this set. Owners everywhere are sending us letters praising its wonderful receptive qualities.

SIMPLE WIRING DIRECTIONS

Very easy to wire this set with the instructions we furnish. Just connect a few wires. All you have to do is to follow numbers. Simple as adding 2 and 2. Can be wired in a few minutes by anyone. No radio knowledge needed. Make money by wiring these sets in your spare time and selling them to your friends.

COMPLETELY WIRED

If you would rather receive Superphonic 7 completely wired, we will be glad to have it wired for you at an additional charge of only \$2.00. Please indicate on your order whether or not you want Superphonic 7 wired.

SEND NO MONEY

Just write your name and address on a postcard and ask us to send you this wonderful outfit. We ship right away. Upon arrival pay only \$16.95 plus a small delivery charge. (Foreign countries send \$19.50 with order. We pay shipping charges.)

RADIO EQUIPMENT CO., 549 S. Wells St., Dept. 12B, Chicago, Ill.

Only \$16.95

COAST to COAST RECEPTION

DRESNER Shielded SHORT WAVE CONVERTER

16.50 Complete with 5 COILS

The Only Set with a Wavelength Range 15 to 550 Meters

First time offered! New model—completely assembled; may be used on any set; built in beautiful mahogany finished metal cabinet. Highest efficiency at amazingly low price. Gets stations broadcast on short waves by many powerful stations throughout U. S. and Europe.

If your dealer cannot supply you, send money or order direct and we will ship at once. Guaranteed. (When ordering unit, be sure to specify whether it is to be used on AC or DC set.)

DRESNER RADIO MANUFACTURING CORP.
640 Southern Blvd., Dept. E-2, New York, N. Y.

Your Tubes STEADY AS THE STARS When AMPERITE-Controlled

Don't let "A" battery current fluctuations spoil your radio reception or ruin your tubes. Install Amperites and automatically keep the filament temperature constant according to tube rating. Entirely unlike fixed resistors. With AMPERITE control tubes last longer and your set sounds better. Panel arrangement improved and wiring simplified. Tuning is easier and volume is increased. A type for every tube—battery or A. C.

\$1.10, with mounting (in U. S. A.) at all dealers. **Radiall Company**, 50 FRANKLIN ST., NEW YORK

FREE "Amperite Blue Book of modern circuits and valuable construction data. Write Dept. RN2.

AMPERITE MEANS "AMPERITE" The "SELF-ADJUSTING" Rheostat

Please say you saw it in RADIO NEWS

FANS! third big edition

Don't
Miss
This
Big
Issue
!

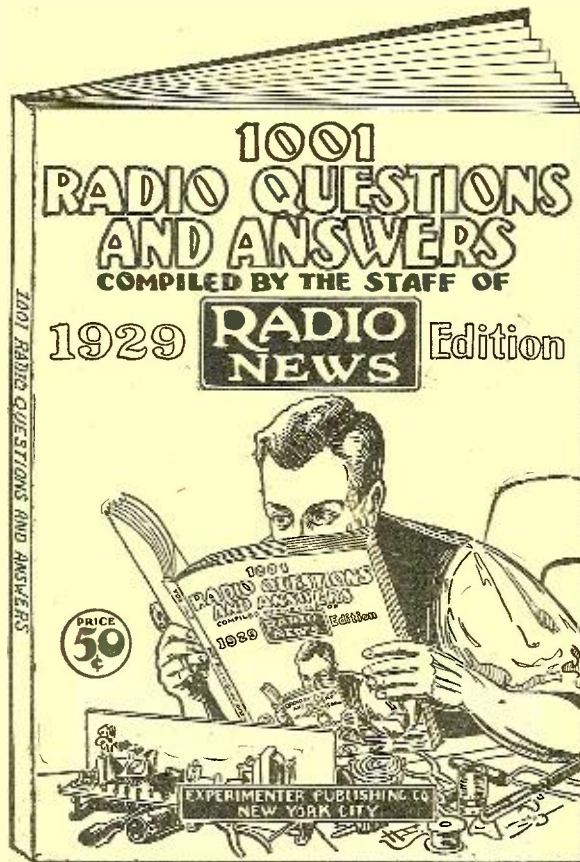

Over
150,000
Copies
Already
Sold
!

Compiled by the Staff of RADIO NEWS

Completely Revised-Up-to-the-Minute

1001 RADIO QUESTIONS AND ANSWERS, the most sensational seller in the radio field, is now in its third new and revised edition. No one interested in radio should be without a copy. The staff of RADIO NEWS, the leading fan magazine, has striven to make 1001 RADIO QUESTIONS AND ANSWERS the foremost work of its kind available. There is a full and complete explanation of every worthwhile circuit that has appeared since the beginning of radio, not only the explanation, but also complete diagrams from which the set can be con-

structed. Concise, authentic answers to every question that can possibly be asked concerning the many and varied branches of radio reception on both short-wave and broadcast bands.

FANS! Don't hesitate! Get your copy today! Over 112 pages — fully illustrated—large magazine size

50c

THE COPY

ASK YOUR NEWSDEALER
OR WRITE DIRECT

EXPERIMENTER PUBLISHING COMPANY, INC.
230 Fifth Avenue, New York, N. Y.

Mail This Coupon NOW!
EXPERIMENTER PUBLISHING CO., INC.
230 Fifth Avenue, New York, N. Y.
Gentlemen: Enclosed is 50c. Please forward
me a copy of "1001 RADIO QUESTIONS
AND ANSWERS."
Name
Address
City
State

Please say you saw it in RADIO NEWS

zona and the Territory of Hawaii. Address Supervisor of Radio, Custom House, San Francisco, Cal. Seventh District: Oregon, Washington, Idaho, Montana, Wyoming, and the Territory of Alaska. Address Supervisor of Radio, Room 2301, L. C. Smith Building, Seattle, Washington.

Eighth District: New York (all counties not included in the Second District), Pennsylvania (all counties not included in the Third District), West Virginia, Ohio and the Lower Peninsula of Michigan. Address Supervisor of Radio, Room 405, Federal Building, Detroit, Mich.

Ninth District: Indiana, Illinois, Wisconsin, Michigan (Upper Peninsula), Minnesota, Kentucky, Missouri, Kansas, Colorado, Iowa, Nebraska, South Dakota and North Dakota. Address Supervisor of Radio, Federal Building, Chicago, Ill.

If successful in the examination, the applicant is granted an amateur first-grade license; if unsuccessful, he must wait three months before he is eligible for re-examination. If the applicant lives in a point remote from the district headquarters, he may submit evidence of his qualifications to the supervisor by mail; and, if the evidence is accepted, he may be granted an amateur second-grade license. To secure the license, the amateur must take an oath to preserve the secrecy of all radio messages which he may hear.

Describing the Transmitter

Before an amateur can construct a station, he must also obtain a station license. The transmitter must be described in detail and a very complete diagram of the transmitting equipment and aerial system must be shown. The type of transmitter must agree with the requirements of the radio laws in the matter of the type of wave emitted and the wavelength used.

Spark transmitters are now banned, because of the serious interference caused by their operation; and the use of conductive coupling in amateur transmitters is no longer permitted with any type of transmitter, except where loop aerials are used. The maximum power input which may be used is limited to 1,000 watts and, where a station is located within five nautical miles of a naval or military radio station, to 500 watts.

The required licenses having been obtained, the amateur may proceed with the operation of his station in accordance with the regulations governing such stations and under the conditions set forth on the license itself. The station cannot be used between the hours of 8:00 and 10:30 p.m. or during the broadcasting of church services on Sundays, on wavelengths between 150 and 200 meters; although on wavelengths below 87.5 meters the station may be operated at any time, provided it does not interfere with radio reception. If the amateur should cause interference on the broadcast band, the radio inspector will withdraw the privilege of operating during the hours mentioned until the amateur can prove that he has eliminated the cause of the interference.

The amateurs in the United States enjoy many privileges not given to amateurs in other countries. That these are appreciated, in most cases, is shown by their efforts to be of public service and by the number of amateurs holding responsible positions in the radio industry. It is also proven by the many developments credited to them.

The information given here for obtaining a license has been put into general form so that it may be of service to anyone because of the great number of letters which we have received on this subject.

CURRENT-CARRYING CAPACITY OF WIRES

(2328) Mr. John Morrison, Havana, Cuba, writes:

(Q.) "In making transformers and other apparatus such as choke coils, requiring windings, I am always bothered by the sizes of wire which I should use. In making the coils, I usually want to make them as small as possible and, for this reason, I like to use the smallest wire that is practical. I have never seen a table of the current-carrying capacities of small wires. Since this would be of interest to a great number of experimenters who make their own transformers and other coils which carry comparatively large currents, I would suggest that you publish one, even though the values are only approximate."

(A.) We give below the approximate maximum currents safely carried by wire of gauges which may be used in designing chokes, transformers, etc. The main consideration is the selection of a wire which will not overheat, when used for long periods of time. In audio-frequency chokes, the currents vary between the limits of a few milliamperes and a number of amperes and, naturally, the design of coils varies considerably with the maximum current to be passed.

The following table may be used in figuring the maximum allowable current in milliamperes which a wire of a certain gauge can handle:

TONE QUALITY

NOW the Carborundum Detector is adjustable. A turn of the pressure screw gives you perfect balance—gives you perfect tone. The detector then remains fixed and permanently sensitive, by tightening the lock nut.

Tone Quality is everything in radio; here is another improvement that further assures it. Recommended by noted radio-circuit designers.

DEALER OR DIRECT, \$1.50 IN U. S. A.
Send for Free Book "Carborundum in Radio"—D-1

THE CARBORUNDUM CO., NIAGARA FALLS, N. Y.
Canadian Carborundum Co., Ltd., Niagara Falls, Ont.

Carborundum is the Registered Trade Mark of The Carborundum Company for its Silicon Carbide and is its exclusive property

CARBORUNDUM
REG. U. S. PAT. OFF.
DETECTOR

Tune In on the Short Waves

Get distance—escape static on the long wave broadcast band. See Call Book for short wave stations. SUBMARINER wave band includes all powerful stations that broadcast programs on short waves—thousands of SUBMARINERS now in use—short waves are the new adventure—a new thrill awaits you.

Short Waves Popular

The SUBMARINER has taken the country by storm. Nothing made like it. Many users have been getting London, England; many get Holland, even in summer. Short waves are great distance carriers, with less static.

Best of All

Your present radio receiver, whether battery operated or all electric, will bring in short wave broadcasting when used with

THE SUBMARINER

It is easy to connect a SUBMARINER. Simply remove a tube from receiving set and place in SUBMARINER socket; then insert SUBMARINER plug in place of tube. Attach regular aerial and ground to clips on SUBMARINER. That's all. No changes in wiring of set necessary. No additional tubes or batteries required. If set operates a loud speaker, it will do so with SUBMARINER. We guarantee that the SUBMARINER will operate within the wave band covered equal to any short wave receiving system known when attached to your receiver. Completely shielded metal cabinet. Fine tuning dial, ratio of 32 to 1. Get the short wave musical programs and other activities, including television signals. Never before has so much in radio been offered for so little money! Order a SUBMARINER now!

FOUR MODELS

20 to 65 meter range—for battery operated radios, \$15.00. For all electric radios, \$17.50. 10 to 160 meter range—for battery operated radios, \$22.50. For all electric radios, \$22.50. 10 to 160 meter range models have three interchangeable coils. A fourth coil, 160 to 340 meter range will be supplied as extra equipment when specified—price \$2.00 additional.

If your dealer does not carry, order direct from factory. Sent anywhere in the U. S. postpaid upon receipt of price. Canada and Foreign, 60c additional. Money order only. Also sent C.O.D. plus postage to U. S. if \$1.00 accompanies order to insure carrying charges. In ordering be sure to name set and tubes used, such as UV-199, UX199, 201A, UX226, or UY227. See dealer or order direct today.

J-M-P MANUFACTURING CO., Inc.

3407 Fond du Lac Ave. Milwaukee, Wis., U. S. A.

\$1 SAVES YOUR SPEAKER

THE CRAFTSMAN DOLLAR SPEAKER FILTER is Guaranteed to relieve your Speaker of the plate D.C. (180 to 250 volts). It reduces overloading, giving Speaker a chance to operate at its best. Can be used as a headphone coupling. Complete protection, \$1.00 prepaid. Invest NOW and prevent Speaker trouble and expense.

CRAFTSMAN RADIO PRODUCTS, 351 Halsey St., NEWARK, N. J.
Improve reception with our Solid Resistors, 30c each.

Insure your copy reaching you each month. Subscribe to Radio News—\$2.50 a year. Experimenter Publishing Co., 230 Fifth Avenue, N. Y. C.

Please say you saw it in RADIO NEWS

OPPORTUNITY AD-LETS

Follow these advertisements every month. Reliable advisers from all over the country offer their most attractive specials in these columns.

Classified advertising rate twenty-six cents a word for each insertion. Names and addresses must be included in the above rate. Cash should accompany all classified advertisements unless placed by an accredited advertising agency. No advertisements for less than 10 words accepted.

Objectionable or misleading advertisements not accepted. Advertisements for the April issue must reach us not later than February 1st.

CIRCULATION LARGER THAN THAT OF ANY OTHER RADIO PUBLICATION

EXPERIMENTER PUBLISHING CO., INC., 230 Fifth Avenue, New York, N. Y.

Agents Wanted

Rejuvenate Old Batteries. Rebuild for \$2.98. Get our cut prices on battery molds, groups, boxes, etc. Wonderful money making plan. Lightning Battery Co., St. Paul, Minn.

\$1 Pays \$20.00. Start This Fastest Big Money Business making World's newest selling specialties. Have others sellings them. Eye-opening literature describing Guaranteed Formulas, Latest Valuable Trade Processes. Free! Small Investment. Profit Immense. Start Anywhere. Miller, Chemist, 706-R Jetton, Tampa, Florida.

Guaranteed Genuine Gold Leaf Letters anyone can put on store windows. Large profits, enormous demand. Free samples. Metallic Letter Co., 422 N. Clark, Chicago.

Agents—\$50. Weekly Selling Shirts. No capital or experience needed. Commissions in advance. Samples Free. Madison Products, 500 Broadway, New York.

Agents Cleaning Up With Lanowa combination. 65¢ clear profit every dollar sale. Write quick for sample. Great Western Industries, 4125-K Penn., Kansas City, Mo.

Big Ohio Corporation has county position open. \$50 weekly commission. Earnings start immediately. Good for \$5000 yearly. We furnish everything, deliver and collect. Capital or experience unnecessary. Fyr-Fyter Company, 1832 Fyr-Fyter Bldg., Dayton, Ohio.

42 Miles On 1 Gallon of Gas—Wonderful new Vapor Moisture Humidifier and Carbon Eliminator. All autos. 1 furnished to test. Critchlow, Inventor, A-143, Wheaton, Ill.

Business Opportunities

Free Book. Start Little Mail Order business. Hadwil, 5A-74 Cortlandt Street, N. Y.

Amateur Cartoonists: Sell Your Cartoons New Plan. Smith's Service EX1194, Wenatchee, Wash.

Inventions Commercialized. Patented or Unpatented. Write Adam Fisher Mfg. Co., 278 Enright, St. Louis, Mo.

Chemistry

Learn Chemistry at Home. Dr. T. O'Connor Sloane, noted educator and scientific authority, will teach you. Our home study correspondence course fits you to take a position as chemist. See our full-page ad on page 778 of this issue. Chemical Institute of New York, 16 E. 30th Street, New York City.

Correspondence Courses

Used correspondence school courses sold on repurchase basis. Also rented and exchanged. Money-back guarantee. Catalog free. (Courses bought). Lee Mountain, Pisgah, Alabama.

Detectives

Detectives Needed Everywhere. Travel. Experience unnecessary. Particulars Free. Write, American Detective System, 2190 Broadway, N. Y.

For Inventors

Inventions Commercialized. Patented or Unpatented. Write Adam Fisher Mfg. Co., 278 Enright, St. Louis, Mo.

If you have a good invention, write Hartley, Box 928, Bangor, Maine.

For Sale

Alfalfa Seeds, hardy common varieties \$8.40, \$10.20, \$12.60 bushel; Grimm variety Alfalfa seed \$18. Scarified sweet clover \$3.90, \$5.20; Alsike or red clover \$15. Bags Free. Send for samples and catalogue. Kansas Seed Co., Salina, Kan.

Help Wanted

A Good Side Line—We Sell Pass books, check covers, coin bags, etc., mainly to banks. They are centrally located and do business quickly. Little time is lost. Our samples are light, compact, easily carried. Sales run into money, items repeat well, commission is liberal, and all paid immediately. We also have a splendid line of printing and advertising novelties for merchants. Our quality is good, the styles interesting. Line is big enough to devote your whole time if you wish. We are manufacturers, own our building, been in business fifteen years, make ten thousand sales a year, ship to every state. You could work wherever you happen to be. Correspondence invited. Continental Bank Supply Co., Mexico, Missouri.

Help Wanted—Instructions

Wanted Immediately, names of hard-working men and women, 18 to 55, who want to make more money. Write, Instruction Bureau, 251, St. Louis, Mo.

Instruction

Learn Chemistry at Home. Dr. T. O'Connor Sloane, noted educator and scientific authority, will teach you. Our home study correspondence course fits you to take a position as chemist. See our full-page ad on page 778 of this issue. Chemical Institute of New York, 16 E. 30th Street, New York City.

Male Help Wanted

Engineer and Factory Manager. A radio engineer thoroughly conversant with the latest improvements in modern broadcast receiver construction, has an unusual opportunity to connect with a substantial Chicago company, whose present financial standing assures future growth. This position offers a real opportunity for an able man. The ability to direct a factory producing several hundred chassis daily would be desirable, but not necessary. Write fully in confidence, covering education, experience, technical training, salary expected, home environment, etc. Address A. O. G., c/o Radio News.

Firemen, Brakemen, Baggage-men (white or colored), Sleeping Car, Train Porters (colored), \$150-\$250 monthly. Experience unnecessary. 237 Railway Bureau, East St. Louis, Ill.

Miscellaneous

Guaranteed Solder for Aluminum, Mail, \$1. Pierman, Belmar, N. J.

Forms to Cast Lead Soldiers, Indians, Marines, Trappers, Animals, 151 kinds. Send 10¢ for illustrated Catalogue. H. C. Schiercke, 1034 72nd St., Brooklyn, N. Y.

Inventions Commercialized. Patented or Unpatented. Write Adam Fisher Mfg. Co., 278 Enright, St. Louis, Mo.

Old Money Wanted

Old Coins. Large Spring selling catalog of coins for sale—free to collectors only. Catalog quoting prices paid for coins, ten cents. William Hesslein, 101E. Tremont St., Boston, Mass.

Old Money Wanted. Do you know that Coin Collectors pay up to \$100.00 for certain U. S. Coins? And high premiums for all rare coins? We buy all kinds. Send for Large Coin Folder. May mean much profit to you. Numismatic Co., Dept. 112, Ft. Worth, Texas.

\$2 to \$500 each paid for hundreds of Old or Old Coins. Keep all old money, it may be very valuable. Send 10¢ for New Illustrated Coin Value Book 4x6. Guaranteed prices. Get posted. We Pay Cash. Clarke Coin Company, 14 Street, LeRoy, N. Y.

Patent Attorneys

Patents—Time counts in applying for patents. Don't risk delay in protecting your ideas. Send sketch of model for instructions or write for free book, "How to Obtain a Patent" and "Record of Invention" form. No charge for information on how to proceed. Communications strictly confidential. Prompt, careful, efficient service. Clarence A. O'Brien, Registered Patent Attorney, 309 Security Bank Building (directly across street from Patent Office), Washington, D. C.

Patents—Free instructions. Former Patent Office Examiner. Moderate terms. Booklet. Albert Jacobs, 740 Barrister Bldg., Washington, D. C.

Patents—Trade-Marks—Preliminary advise gladly furnished without charge. Booklet of information and form for disclosing idea free on request. Irving L. McCathran, 706 International Building, Washington, D. C. or 41-18 Park Row, New York City.

Patents—Write for Free Instructions. Send Drawing or Model for Examination. Carl Miller, Registered Patent Attorney (former Patent Office Examiner), 202 McGill Building, Washington, D. C.

Patents—Send for form "Evidence of Conception" to be signed and witnessed. Form, fee schedule, information free. Lancaster and Allwine, Registered Patent Attorneys in United States and Canada, 289 Ouray Bldg., Washington, D. C.

Patents—Send drawing or model of your invention for examination and instructions. Advice and booklet free. Highest references. Best results. Promptness assured. Watson E. Coleman, Patent Lawyer, 724 9th Street, N.W., Washington, D. C.

Patent Attorneys (Cont.)

Inventors—Should write for our Free guide Book, "How to Obtain a Patent" and Record of Invention Blank. Send Model or sketch and description of inventions for Inspection and Advice Free. Radio, Electrical, Chemical, Mechanical and Trademark Experts. Terms Reasonable. Victor J. Evans & Co., 922 Ninth, Washington, D. C.

Patents

Inventions Commercialized. Patented or unpatented. Write Adam Fisher Mfg. Co., 278 Enright, St. Louis, Mo.

Printing, Engraving and Multigraving

200 Letterheads and 100 Envelopes, \$1.10, Postpaid. Oberman Company, Box 1042, Chicago.

Multigraving, two dollars thousand. Miscellaneous Printing. Mayer Rey Corporation, Monmouth, Illinois.

Radio

Chemistry in Radio. Complete outfit full of miscellaneous chemicals, metals, apparatus, etc. Complete set of chemical and radio experiments, even television included. Never before offered for sale at \$4.98 prepaid U. S. A. Send money order, or C. O. D. Chemical Radio Co., 4730 Drexel Blvd., Dept. A, Chicago, Ill.

Bargains, used radios. Guaranteed perfect working order. Blue Ribbon 5 tube, 2 dial, Console \$19.95. Freshman \$14.95. Atwater Kent \$19.50. Tubes included. Many famous makes. Send money order with order. Bargain list on request. Surplus Radio Co., Dept. 2, 549 S. Wells, Chicago.

Wanted: Men to work with National Radio Service organization. No selling scheme. Radio Doctors, Inc., Dept. N. Essex St., Salem, Mass.

Used 5 tube Sets \$9.90 in table model cabinets. T. R. F. circuit. Require slight repairs. We don't test them but in most cases, they are perfect. See our display advertisement on page 793, this issue. Three tube sets. Same as above \$6.90; UX 280B eliminator tubes \$1.75; audio transformers, \$1.75; 30 henry chokes, \$1.00; 2 microfarad condensers, \$1.95; Belt transformers \$1.45; Crosley Supreme units, \$2.50; Radiola Loop Antennas, \$1.45; Crosley or Atwater-Kent walnut panels 9x28 inches \$3.85; Rheostats \$3.25; Sockets \$1.15; Battery cables \$3.35; Potentiometers \$3.35; Glodials \$1.65; Panels 6x10 \$2.25. Send money order with order. C. Hoodvink Co., 4240 Lincoln Ave., Chicago, Ill. Dealers in Bankrupt Stocks.

Song Writers

Song-poem writers. Address, Monarch, 236 West 53th Dept. 122, New York.

Song Poems Wanted: Write at once. Valuable instruction book given free! Bell Music Co. D-11, St. Louis, Mo.

Telegraphy

Telegraphy—Both Morse and Wireless taught thoroughly. Big salaries. Wonderful opportunities. Expenses low, chance to earn part. School established fifty years. Catalog free. Dodge's Institute, Cour St., Valparaiso, Ind.

AEROVOX Makers of high quality resistors and condensers that are Built Better — to endure. Write for The Research Worker. A free monthly publication. **AEROVOX WIRELESS CORPORATION** 68 Washington Street Brooklyn, N. Y.

NEWS to Set Builders
Barawik offers set builders bigger bargains — bigger opportunities to make money this season. New sets, new kit ideas, all the leading parts, dynamic speakers, supplies, etc. Lowest rock-bottom prices. Bigger stocks, quicker service. Send for Big Bargain Book today—free.
BARAWIK CO., 22 E. Canal St., CHICAGO, U. S. A.
Mail This Coupon Now! For Free Copy
Name
Address

Please say you saw it in RADIO NEWS

Table A

Copper wire B & S Gauge	Current in Milliamperes
16	2,000 to 2,600
18	1,200 to 1,600
20	700 to 1,000
22	450 to 650
24	300 to 400
26	175 to 250
28	100 to 160
30	65 to 100
32	40 to 65
34	25 to 40
36	18 to 25
38	10 to 15
40	5 to 10

Since the resistance of the wire is an important point in the design of coils also, we print a list of the resistance values for the various gauges of wire, and also the number of turns per inch which can be wound with double-cotton-covered wire.

In figuring the space required for a multi-layer coil, the linear turns per inch can be squared to give the number of turns per square inch which can be wound into a slot; and simple proportion will then supply the figure for the required space.

Table B

Copper Wire B & S Gauge	Ohms per 1,000 Feet	Turns per Linear Inch (D.C.C.)
16	4.09	16.7
18	6.51	20.4
20	10.4	24.4
22	16.5	30.0
24	26.2	35.6
26	41.6	41.8
28	66.2	48.6
30	105.	55.6
32	167.	62.9
34	266.	70.0
36	423.	77.0
38	673.	83.3
40	1,070.	90.9

DANTE OVERLOOKED A BET

Ghoulish advice given by the *Peoria Journal* of August 25: "The ground connection should be attached to a water pipe driven into the SOUL."



We know some blooper owners whom we would like to utilize in this manner; but we fear they are too small-souled for the purpose.
—Charles Henry.

VOLTAGE WILL OUT!

Convincing advertisement from the "Help Wanted" column of the *San Francisco Examiner* of August 12: "Strange battery compound charges DISCHARGES batteries instantly. Eliminates rentals, gives new life and pep. Big profits, gallon free, Lightning Co." That is to say, we are convinced the unfortunate battery would be in need of help after one application.—E. H. Peck.

Station
WRNY
NEW YORK

297 METERS—1010 KILOCYCLES
and W2XAL, 30.91 METERS

is owned and operated by the
publishers of this magazine
Our Editors will talk to you
several times every week—
See your Newspaper
for details
**TUNE IN ON
WRNY**

Any A. C. Socket Power Set can be used on D. C. supplies—
if an "ESCO" Motor Generator or Dynamotor is used

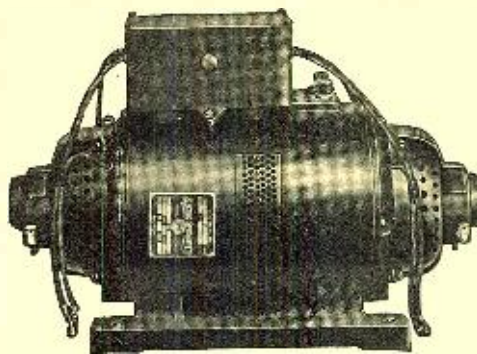

Motor Generator with Filter
For Radio Receivers

Machines for operating 60-cycle A. C. Radio Receivers, Loud Speakers and Phonographs from Direct Current Lighting Sockets Without Objectionable Noises of any Kind.

The dynamotors and motor generators are suitable for radio receivers and for combination instruments containing phonographs and receivers. Filters are usually required. The dynamotors and motor generators with filters give as good or better results than are obtained from ordinary 60-cycle lighting sockets. They are furnished completely assembled and connected and are very easily installed.

These machines are furnished with wool-packed bearings which require very little attention, and are very quiet running.

Write for Bulletin No. 243-C.

ELECTRIC SPECIALTY COMPANY

211 South Street

Stamford, Conn., U. S. A.

TRADE "ESCO" MARK

Manufacturers of Motors, Generators, Motor - Generators,
Dynamotors and Rotary Converters for Radio and other purposes

Send for WESTERN RADIO

new
1929 Catalog

DEALERS AND SETBUILDERS

THE NEW 1929 Catalog is crammed full of the FINEST, NEWEST, nationally-known A.C. sets, consoles, cabinets, dynamic speakers, kits, eliminators, and accessories at LOWEST PRICES. Largest stock of Radio Parts. Prompt delivery. Write for our FREE catalog.

WESTERN RADIO MFG. CO.
128 WEST LAKE ST. Dept. RN-2 CHICAGO, ILL.

The Big Friendly Radio House



A REAL SPECIAL OFFER!!



UNI-RECTRON POWER AMPLIFIER

Ideal for use with Dynamic Speakers)

Model AP-935



As the Uni-Rectron stands it is a super power amplifier, which can be used in connection with any radio set and loud speaker. Binding posts are provided for input to the Uni-Rectron and output to the speaker.

Requires no batteries for its operation. It obtains its power from the 110 volt, 60 cycle alternating current lighting circuit of your house.



List Price \$88.50
(without tubes)

Special - \$19.75 ea.

Every one new and packed in original factory carton

The UX-210 super power amplifying tube and the UX-216B or 281 rectifying tube are used with this amplifier, which cannot overload. From the faintest whisper to the loudest crash of sound—R. C. A. Uni-Rectron amplifies each note at its true value. High and low notes are all treated alike. The volume and quantity delivered will be a revelation.

AMERICAN SALES CO., 19-21 WARREN ST., NEW YORK CITY

Please say you saw it in RADIO NEWS

Startling Price Reductions

Buy Now!

Allied has cut prices to the bone—your big profits in radio can now be bigger—no need to wait any longer. This new low level of prices places before you the season's outstanding values.

**On Everything
In RADIO**

RADIO 1929
PRE-INVENTORY CLEARANCE
EVERYTHING IN RADIO
A.C. SETS - D.C. SETS
DYNAMIC SPEAKERS
PARTS - KITS
ACCESSORIES

NET WHOLESALE PRICES

ALLIED RADIO CORPORATION
711 W. LAKE ST. CHICAGO, ILL.

THE PRICE SLASHING EVENT OF THE YEAR

Brand New Catalog for 1929

A pre-inventory sale that is featuring some of the most drastic price reductions known to radio. Everything in our tremendous stock is offered in this sale—and this large new catalog has been prepared to bring before you this tremendous array of radio values.

Every branch of the radio industry is represented—appealing to set builders interested in parts and kits—to dealers interested in the new sets and modern accessories—as well as agents who are interested in tying up with one of the season's most successful lines of A.C. and D.C. receivers.

Wholesale Prices

Selling as we do on an exclusively wholesale basis, the prices we now offer you are establishing new standards in radio values—new A.C. sets as low as \$32.95—attractively designed consoles for as low as \$16.25. Corresponding values are offered in kits, parts and accessories in nationally-advertised, quality merchandise—the products of the country's foremost radio manufacturers.

The Catalog is Free
Send for Your Copy Now

Knight Receivers for A. C. and D. C. operation have established an enviable record for performance. See them in this new large catalog.

Allied Radio CORPORATION
711 W. LAKE ST. Dept. B-4 CHICAGO

Please say you saw it in RADIO NEWS

Ready for you now ~

SCOTT'S World's Record SHIELD GRID NINE *All Electric!*

HERE it is! The World's Record Scott *Electrified!* The finest of laboratory Shield Grid models, available now for A. C. light socket operation.

Thousands have asked us for an A. C. Electric set offering all the superb qualities of the famous Scott battery-operated set that established four authoritative world's DX records. We were not ready to offer A. C. operation until we had made several important improvements, including a newly developed "A" Eliminator, that would insure A. C. reception as good and better than with battery power.

Unlimited Range with Superb Tone and Volume

Now we are ready to announce the ultimate in A. C. radio reception—this wonderful new A. C. World's Record Shield Grid Nine! Fully electrified—and affording all the convenience of light socket operation. No batteries to worry about; no chargers of any sort. Just plug into your A. C. light socket, and listen to a revelation of all-electric radio reception such as you have never heard before.

Rangeless distance—volume—tone—selectivity—all are yours, to a degree of flawless perfection that astounds even in this day of enormously improved radio.

Build in Four Hours Results Guaranteed

There are no tricky adjustments to this A. C. set. You can build it in four hours, easily. Simply wire it up—plug in—and you have your receiver operating at maximum efficiency. Shielded grid amplifier unit comes fully tested and wired. Transformers are perfectly matched, with no exterior adjustments to make. Every part of this remarkable A. C. receiver is designed especially for this set, including the new perfected "A" Eliminator, and all are matched with laboratory precision.

We guarantee that you can build the New Scott Nine and get the same results we obtain from our Laboratory models.

Amazing Output Insures Extreme Selectivity

The tuned R. F. and Shield Grid Long Wave R. F. of the Scott Nine give truly amazing results. The tremendous output of this set is much greater than that of the average good "super." As a result, extreme selectivity is always

obtainable. Not "fussy," uncertain selectivity; but razor-sharp sensitivity, obtainable in a stable circuit condition with tubes operating at normal voltage.

Low Cost Operation

The New Scott A. C. Shield Grid Nine combines tremendous power with unusual operating economy. The eight tubes incorporated in the receiver draw only 29 mls. Maximum volume is obtained by the use of the Scott Power Pack and Amplifier, incorporating the ninth tube for the second stage of audio. The latest 250 power tube is used, providing tremendous power with perfect tone quality.

SET BUILDERS!

Sell in a protected market

To build up a permanent, prosperous business, you must have the kind of support that Scott gives you. Read every word of Mr. Scott's statement on pages 00 and 00. You can't afford to spend time, effort and ability building up a demand in your community only to have it supplied through "net-price" catalogs.

Get behind this fine receiver. It sells on demonstration. We help you secure and bring in prospects through our elaborate sales plan, including mailing folders, with your name imprinted, valuable Sales Manual and other selling helps. Tie up with this money-making plan. Make each day build for the future—the day when you will have a real, profitable business. Write for particulars today.

FREE! PLANS!

Write at once for free circuit diagrams and full particulars about the Scott A. C. Shield Grid Nine. Also copies of authoritative 6000 and 5000 mile reception tests. Get all the amazing facts about this World's Record Set. Also particulars about battery-operated set. Mail coupon below.

Radio's Greatest DX Performer



SCOTT TRANSFORMER CO., 4448 Ravenswood Ave., CHICAGO
Clip this Coupon for particulars

Send full particulars about the Scott World's Record Shield Grid Nine, including Free Circuit Diagram, world's record test verifications, etc.
 A. C. Model
 Battery operated Model
 Send also particulars about your special proposition to professional set builders.

Name Town
 Street State

FACTORY TO YOU—SAVE 50%—COMPARE WITH COSTLIEST OUTFITS BEFORE YOU BUY

Enjoy a powerful new **Miraco** set or complete outfit **30 DAYS FREE**

AC Electric or Battery

Get Our
Send No
Money
9th
Anniversary
Offer!



**3
Year
Guarantee**

**Built like, Looks like,
Performs like a
\$200 set**

Marvelous new 3-year guaranteed, lighted 1-dial control. All metal Super Shielded Miraco set, removed from cabinet. Front switch, phonograph pick-up connection and all latest features. Built in power section on AC models.

**The Latest, Finest and
Costliest Construction**

\$49⁸⁸
COMPLETELY ASSEMBLED

**NEW LOW
FACTORY PRICES
SAVE 50%**

**Wide Selection of
Beautiful Cabinets
AC or Battery Sets**

30 DAYS HOME TRIAL



A popular walnut Hi-Boy Console, with drop-leaf desk. Beautiful two-tone finish. Rare bargain!

Richly designed, genuine walnut console of finest type. Electro-dynamic or magnetic power cone, or long air column speaker. Marvelous value.



Beautifully graceful spinet console, genuine two-tone walnut. Choice of speakers. Also comes in Electric Phonograph-Radio Combination.



A new-type arm-chair console. Genuine walnut. Very pretty. Low priced. Electro-Dynamic or Magnetic-Power Speakers.



At right, a Lo-Boy console, walnut finish, that costs little. A gem!



Above, popular inexpensive combination. Set on-Table Speaker (sold separately).



Metal or wood compact style cabinets. Wood cabinets in walnut or new shaded silver-chrome finishes. Cathedral Electro-Dynamic or Magnetic-Power Speaker to match!

8 tube ~ one dial Electric Lighted

MIRACO

TRADE MARK REGISTERED

CATHEDRAL TONED, SUPER SELECTIVE, POWERFUL DISTANCE GETTERS

Celebrating its 9th successful year, America's big, old, reliable Radio Corporation springs a genuine sensation in high-grade sets. With its latest, Super-powered, 1-dial features, including

pick-up connection, ease of tuning, beauty, and economy—a Miraco will make you the envy of many whose radios

BIG DISCOUNTS
Exclusive Territory
to User-Agents on
**BATTERY OR AC
ELECTRIC OUTFITS**

for batteries or Eliminators—you are guaranteed values and savings unsurpassed in the fine set field. Compare a Miraco with highest-priced radios, for 30 days in your home. Surprise and entertain your friends—get their opinions. Unless 100% delighted, don't buy it! Return everything—the complete outfit—at our expense. Your decision is final—absolutely!

Only exceptionally fine radios, of the very latest approved type, at rock-bottom prices, could possibly back up so liberally unconditional a guarantee. Send coupon now for **Amazing Special Factory Offer!**

Don't Confuse with Cheap Radios With its rich, clear Cathedral tone,

Miraco Outperforms 'em All In Chicago On the Miraco Unitone, to start with, will say: I got to date 61 stations outside of Chicago, from the Pacific Ocean to the Atlantic Ocean, and from Anchorage, Alaska, to the Gulf of Mexico, and I tried the set with 3 different antennas. That is an outside aerial 132 feet, an inside aerial 20 feet, and

cost 2 to 3 times as much! Many thousands of Miracos—bought after 30 day home comparisons—are cutting through locals and getting coast to coast with the tone and power of costly sets, their delighted users report. Miracos are laboratory-built with finest parts, and embody 9 years' actual experience in constructing fine sets. Approved by Radio's highest authorities.

Deal Direct with Big Factory Everything reaches you splendidly packed and rigidly tested to insure your instant enthusiasm. Enjoy the outfit 30 days—then decide. Liberal 3-year guarantee on each set. Play safe, save lots of money, and insure satisfaction by dealing direct with Radio's old, reliable builders of fine sets—9th successful year.

light socket. I want to say that your set does outperform the other sets I have. I put it up against a World Record Super 9 and beat that one. Then I put it up against a (names expensive make), and beat that one. Next I put it up against a Neutrodyne and beat that one. HARRY KOPP, 6555 South Peoria Street, Chicago, Illinois.

MIDWEST RADIO CORPORATION, 404-RF Miraco Building, Cincinnati, Ohio
BEAUTIFULLY ILLUSTRATED CATALOG, AMAZING SPECIAL FACTORY OFFER, TESTIMONY OF NEARBY USERS—All the proof you want—of our honesty, fairness, size, financial integrity, radio experience and the performance of our sets—including Amazing Factory Offer—sent with catalog.



Free!

MIDWEST RADIO CORPORATION
Pioneer Builders of Sets—9th Successful Year
404-RF Miraco Bldg., Cincinnati, Ohio

**THIS COUPON
IS NOT
AN ORDER**

WITHOUT OBLIGATION, send free catalog, Amazing Special Factory Offer, testimony of nearby users, etc. User Agent Dealer
 Check here if interested in an **EXCLUSIVE TERRITORY PROPOSITION**
NAME ADDRESS